

INTERNATIONAL LASER RANGING SERVICE

# 2003-2004

ANNUAL REPORT

June 2005

Edited by M. Pearlman and C. Noll

NASA/TP—2005-212780

## The NASA STI Program Office ... in Profile

Since its founding, NASA has been dedicated to the advancement of aeronautics and space science. The NASA Scientific and Technical Information (STI) Program Office plays a key part in helping NASA maintain this important role.

The NASA STI Program Office is operated by Langley Research Center, the lead center for NASA's scientific and technical information. The NASA STI Program Office provides access to the NASA STI Database, the largest collection of aeronautical and space science STI in the world. The Program Office is also NASA's institutional mechanism for disseminating the results of its research and development activities. These results are published by NASA in the NASA STI Report Series, which includes the following report types:

- **TECHNICAL PUBLICATION.** Reports of completed research or a major significant phase of research that present the results of NASA programs and include extensive data or theoretical analysis. Includes compilations of significant scientific and technical data and information deemed to be of continuing reference value. NASA's counterpart of peer-reviewed formal professional papers but has less stringent limitations on manuscript length and extent of graphic presentations.
- **TECHNICAL MEMORANDUM.** Scientific and technical findings that are preliminary or of specialized interest, e.g., quick release reports, working papers, and bibliographies that contain minimal annotation. Does not contain extensive analysis.
- **CONTRACTOR REPORT.** Scientific and technical findings by NASA-sponsored contractors and grantees.

- **CONFERENCE PUBLICATION.** Collected papers from scientific and technical conferences, symposia, seminars, or other meetings sponsored or cosponsored by NASA.
- **SPECIAL PUBLICATION.** Scientific, technical, or historical information from NASA programs, projects, and mission, often concerned with subjects having substantial public interest.
- **TECHNICAL TRANSLATION.** English-language translations of foreign scientific and technical material pertinent to NASA's mission.

Specialized services that complement the STI Program Office's diverse offerings include creating custom thesauri, building customized databases, organizing and publishing research results . . . even providing videos.

For more information about the NASA STI Program Office, see the following:

- Access the NASA STI Program Home Page at <http://www.sti.nasa.gov/STI-homepage.html>
- E-mail your question via the Internet to [help@sti.nasa.gov](mailto:help@sti.nasa.gov)
- Fax your question to the NASA Access Help Desk at (301) 621-0134
- Telephone the NASA Access Help Desk at (301) 621-0390
- Write to:  
NASA Access Help Desk  
NASA Center for AeroSpace Information  
7121 Standard Drive  
Hanover, MD 21076-1320

INTERNATIONAL LASER RANGING SERVICE

# 2003-2004

ANNUAL REPORT

June 2005

Edited by M. Pearlman and C. Noll

Goddard Space Flight Center  
Greenbelt, MD 20771

NASA/TP—2005-212780

Available From:

NASA Center for Aerospace Information  
7121 Standard Drive  
Hanover, MD 21076-1320  
Price Code: A17

National Technical Information Service  
5285 Port Royal Road  
Springfield, VA 22161  
Price Code: A10

---

# PREFACE

---

This 2003-2004 volume is the fourth published report for the International Laser Ranging Service (ILRS). This report once again concentrates on achievements and work in progress rather than ILRS organizational elements. The 2003-2004 ILRS report is structured as follows:

- Section 1, ILRS Organization, reviews the service and its role in space geodesy.
- Section 2, ILRS Tracking Network, provides the current status and recent performance statistics of the international stations supporting the ILRS and offers a perspective on site surveys and system collocations. An update on site survey activities is also provided.
- Section 3, ILRS Missions and Campaigns, gives information about many of the current and future missions supported by the ILRS.
- Section 4, Infrastructure, details recent activities tackled by the ILRS Central Bureau, including Web site improvements and data center developments.
- Section 5, Tracking Procedures and Data Flow, discusses satellite predictions, ILRS tracking priorities, recent developments in the area of dynamic priorities, and the flow of on-site normal points and full-rate data.
- Section 6, Emerging Technologies, includes information about high repetition rate lasers and systems, detectors, timers and frequency standards, multi-wavelength ranging, and other hardware that will help advance the accuracy and automation of laser ranging systems. Also included are new applications for the SLR technique.
- Section 7, Analysis Pilot Projects, reviews the recent developments in the ILRS Analysis Working Group including the three pilot projects begun in 2002, Computation of Station Positions and EOPs, Orbits, and Software Benchmarking.
- Section 8, Modeling, discusses recent advancements in refraction modeling and satellite center of mass corrections.
- Section 9, Science Coordination, examines the ILRS role in the ITRF, its synergy with the other geodetic techniques, and some interesting applications for both SLR and LLR.
- Section 10, Meetings and Reports, reviews ILRS-related meetings in 2003-2004 and reports issued by the service over that period.
- Section 11, Bibliography, lists some of the papers and presentations about SLR and LLR science and technology made during 2003-2004.
- Appendix A, AC and AAC Reports, presents individual summaries from ILRS analysis and associate analysis centers.
- Appendix B, Station Reports, includes information received from the stations contributing to the ILRS network.
- Appendix C, ILRS Information, lists organizations participating in the ILRS and defines acronyms used in this annual report.

This report is also available through the ILRS Web site at URL  
[http://ilrs.gsfc.nasa.gov/reports/ilrs\\_reports/ilrsar\\_2003.html](http://ilrs.gsfc.nasa.gov/reports/ilrs_reports/ilrsar_2003.html).

---

*For further information, contact the ILRS Central Bureau:*

Michael Pearlman  
Director, ILRS Central Bureau  
Harvard/Smithsonian Center for Astrophysics  
60 Garden Street  
Cambridge, MA 02138  
USA  
*mpearlman@cfa.harvard.edu*

Carey Noll  
Secretary, ILRS Central Bureau  
NASA Goddard Space Flight Center  
Code 690.1  
Greenbelt, MD 20771  
USA  
*Carey.Noll@nasa.gsfc*

ILRS Web site: *<http://ilrs.gsfc.nasa.gov>*

A complete list of ILRS associates can be found on the ILRS Web site at  
*[http://ilrs.gsfc.nasa.gov/contact\\_ilrs/ilrs\\_netdir.html](http://ilrs.gsfc.nasa.gov/contact_ilrs/ilrs_netdir.html)*.

# ACKNOWLEDGMENTS

---

The editors would like to acknowledge the essential contributions from our ILRS colleagues and their supporting organizations to this 2003-2004 ILRS Report.





# TABLE OF CONTENTS

---

Preface .....	i
Acknowledgment .....	iii
Introduction .....	1
Chairperson’s Remarks.....	5
Section 1 – ILRS Organization.....	1-1
Section 2 – ILRS Tracking Network .....	2-1
Section 3 – ILRS Missions and Campaigns .....	3-1
Section 4 – Infrastructure.....	4-1
Section 5 – Tracking Procedures and Data Flow .....	5-1
Section 6 – Emerging Technologies .....	6-1
Section 7 – Analysis Pilot Projects.....	7-1
Section 8 – Modeling.....	8-1
Section 9 – Science Coordination.....	9-1
Section 10 – Meetings.....	10-1
Section 11 – Bibliography.....	11-1
Appendix A: AC and AAC Reports	
AIUB.....	A-1
ASI/CGS .....	A-3
BKG .....	A-5
CSR.....	A-6
CSR Lunar .....	A-10
DGFI .....	A-11
DUT .....	A-13
ESA/ESOC.....	A-15
FFI.....	A-17
GAOUA.....	A-19
Geoscience Australia .....	A-21
GFZ.....	A-22
IAA .....	A-24
JAXA .....	A-26
JCET.....	A-28
JPL .....	A-32
MCC.....	A-35

Newcastle University .....	A-39
NICT .....	A-40
NSGF .....	A-41
OCA/GEMINI .....	A-43
POLAC .....	A-47

#### Appendix B: Station Reports

Arequipa.....	B-1
Beijing .....	B-2
Borowiec .....	B-4
Changchun .....	B-6
Concepción.....	B-7
Grasse and FTLRS.....	B-8
Graz.....	B-12
Greenbelt.....	B-15
Haleakala .....	B-16
Hartebeesthoek .....	B-18
Helwan .....	B-19
Herstmonceux .....	B-20
Katzively .....	B-23
Kiev .....	B-25
Lviv .....	B-26
Matera .....	B-28
McDonald.....	B-29
Metsahovi.....	B-30
Monument Peak .....	B-31
Mount Stromlo .....	B-32
Potsdam.....	B-36
Riga .....	B-37
San Fernando .....	B-39
Simeiz .....	B-41
Simosato.....	B-43
Tahiti .....	B-44
Tanegashima .....	B-46
Wetzell .....	B-47
Yarragadee .....	B-48
Zimmerwald.....	B-49

#### Appendix C: ILRS Information

ILRS Organizations .....	C-1
Acronyms .....	C-3

# THE ILRS:

---

## AN IMPORTANT SERVICE FOR SCIENCE AND PRACTICE

The International Laser Ranging Service (ILRS) has undergone a considerable evolution since its emergence from the Sub-Commission of the IAG Commission on International Coordination of Space Techniques for Geodesy and Geodynamics (CSTG) in 1998. While the objectives of the Sub-Commission were concentrated primarily on geodetic research for precise global positioning and gravity field determination we find today a broad spectrum of investigations and products for many areas in science and applications.

The first striking results of SLR were the precise positions of globally distributed observation stations at the end of the 1970's. While previous satellite positioning techniques, like optical and Doppler methods, found their limits in the meter or decimeter level of precision, SLR brought the breakthrough to centimeter accuracy. By this means the detection of motions of the Earth surface became achievable from repeated SLR positioning. The first global confirmation of the ongoing process of the geophysical hypothesis of plate tectonics was derived from the baseline changes between SLR tracking stations. The precise SLR orbit determination needed for the data processing entered into the global gravity field determination which was no longer restricted to locally observed terrestrial gravimetric data but could benefit from the global coverage of SLR orbits.

In the decades since the inception of SLR and other space geodesy techniques (VLBI and GPS) sophisticated models of global plate kinematics and the gravity field have been developed. The densification of the global SLR network by permanent and mobile stations allowed us to also model regional deformations, in particular in plate boundary zones. But the striking achievements were not only used for advancing geophysical research but also for revolutionizing geodesy. The terrestrial reference frames (TRF) for geodetic positioning and surveying, formerly defined in each country by local datums in arbitrarily chosen fundamental stations, could now be unified into a global system, providing consistency of coordinates across national borders and allowing extended surveying without undertaking transformations between the various datums. On the other hand, geodesy had to learn that coordinates of points at the Earth surface are not fixed over all times, but that they vary with time due to the point motions. This is why the global TRFs now include station coordinates for a defined epoch and station velocities. This was a dramatic change for many applications in practice.

In parallel to the advances in SLR, Lunar Laser Ranging (LLR) was developed to a high level. Although only a few lunar tracking stations have been available over the globe due to the high costs of installation and operation, very important results in lunar research have been achieved. Models for the orbit and libration of the moon have been significantly improved and the geocentric gravitational constant (GM) has been determined to far greater accuracy, still indicating no change with time. LLR results have now been included in the determination of the International Terrestrial Reference Frame (ITRF).

The increasing accuracy of the ITRF attracted users from many different disciplines. They realized the advantages of a worldwide, unified reference system of coordinates and the benefit of satellite ephemerides in such a reference system. The ILRS was approached by various agencies and institutions requesting tracking support for their satellites dedicated to research and application programs. Thus the ILRS became an important service for science and practice. Today we see many satellite missions basing their orbit determination on SLR tracking and using SLR to validate other methods of orbital measurement.

---

Modern terrestrial reference frames are not thinkable without SLR data. The TRFs are defined and assumed as “geocentric” systems. However, the geocenter, i.e., the centre of mass of the entire Earth system, is not directly accessible and the origin of a coordinate system can only be placed into the geocenter by integrating the gravitational effects of all of the Earth’s mass. SLR measures directly the two-way range to satellites (measuring round-trip time) rather than the one-way differenced measurements of other techniques, which means that SLR is capable of precisely estimating the globally integrated gravity effects on the satellites’ orbits, in particular the one degree and order terms of the spherical harmonic expansion of the gravity field (C10, C11, S11) which define the geocenter and therefore the origin of the coordinate system.

The capability of estimating precisely and reliably the lower spherical harmonic coefficients is also an important prerequisite for global gravity field determination. Modern satellite gravity missions provide unprecedented accuracy in the medium wavelength components of the gravity field. For the unique reference of global gravitational models (GGM), however, we need stable lower spherical harmonic coefficients, which are provided by the analysis of SLR data. Moreover, the long-term stability of GGMs requires the inclusion of precise estimates of the time derivatives of the coefficients (variations with time, in particular of C20 or, equivalently, J2). These are derived primarily from SLR data.

Geodetic research and applications are becoming more and more complex and sophisticated. The requirements for science and practice are dramatically increasing, in particular with respect to the consistency and reliability of measurements, models and products. Therefore we have to integrate all the geometric and gravimetric observations into a unique system with consistent models and parameters. For this reason the International Association of Geodesy (IAG) initiated in July 2003 the Global Geodetic Observing System (GGOS). GGOS provides the scientific and infrastructure basis from geodesy for all global change research in Earth sciences. It is based on the IAG services, and the ILRS plays an important role in this system.

The mission of GGOS is to ensure the collection, the archiving and the accessibility of all geodetic observations and models as well as the robustness of the estimated parameters in the three fields of geodesy, namely geometry and kinematics, orientation and rotation, and gravity field of the Earth. Among the objectives we emphasize the consistency between the different geodetic standards, models and products, and the maintenance of stable geometric and gravimetric reference frames. SLR is a key element for these objectives because it contributes to all three fields. Due to the very long observation history and derived parameter series it guarantees the long-term stability more than any other geodetic technique.

The objectives of GGOS also include the representation of geodesy in international scientific, political and societal organizations. IAG has become a participating organization in the inter-governmental ad-hoc Group on Earth Observations (GEO). GEO was established in 2003 by a declaration of 33 nations plus the European Commission during the Earth Observation Summit (EOS I) in Washington, D.C. The declaration signifies the political commitment to move toward the development of a comprehensive, coordinated, and sustained Earth observation systems, and the Summit affirmed the need for global information based on continuous monitoring of the state of the Earth as a basis for sound decision making. The main objective of GEO is to improve coordination of strategies and systems for Earth observations. The first step is to prepare a 10-year implementation plan for a Global Earth Observation System of Systems (GEOSS) taking into account existing activities and building on existing systems and initiatives.

The vision of the GEOSS is to realize a future wherein informed decisions and actions for the benefit of humankind

---

are made through coordinated, comprehensive, and sustained Earth observations. It should be a system of systems with components consisting of existing and future Earth observation systems spanning the full cycle from primary observation to information production. It should include all components of the Earth's system and provide policy makers with information for their decisions on natural disaster prevention, climate change prediction, etc. Representatives of IAG are participating in the development of the 10-year implementation plan for GEOSS, bringing in the full array of geodetic components. We mention in particular the existing geodetic stations cited as an opportunity for co-located Earth observation sites, and the geodetic services advocated for continuity and interoperability of satellite systems to provide positioning. The geodetic reference frames are emphasized for ground truth and common geographic data integration, and the Global Geodetic Observing System (GGOS) is considered one of the existing systems to be integrated into GEOSS.

The ILRS will have its role in both GGOS and GEOSS. From the historical reflections we learn that SLR is one of the most important sources of information for global geodesy, i.e., the measurement of the Earth surface and its variability, and it provides – directly or indirectly – significant data for other scientific branches, practical applications, and societal requirements.

We understand that in today's world there are severe budget constraints, so we must prioritize wisely. Maintaining continuous operation of a modest-size, global well-distributed network of SLR stations and the timely processing of data for providing the needed products are of major importance to our society. As has been historically demonstrated, this should be the task of the international community, with many agencies contributing, sharing systems, technology, data, and data products. Recent cutbacks have had a deleterious effect on the SLR contribution. We need to work together to make funding agencies aware of this important international resource. It is important that this ILRS report and other ILRS documents be given to the decision makers and budget managers to better familiarize them with the success and importance of both SLR and LLR for science and society.

Hermann Drewes  
President of IAG Commission 1  
DGFI, Muenchen, Germany



# CHAIRMAN'S REMARKS

---

This report covers ILRS activities for 2003 and 2004. The two years have been consolidated because many other ILRS reports have already been issued during this period and we wanted to give all of the field stations and the analysis groups the opportunity to provide individual reports on their own activities.

We have had some very difficult challenges during this reporting period. On January 18, 2003 a bushfire destroyed one of our most prolific SLR stations at the Mount Stromlo Observatory in Australia. However, thanks to enormous and dedicated efforts by governmental institutions and private companies the station was rebuilt. At the opening ceremony on April 1st, 2004, the Chair of the ILRS Governing Board presented a plaque to Federal Industries, Tourism and Resources Minister Ian Macfarlane, in recognition of this effort and the important role that the stations play in the service's activities. The new SLR station in Tanegashima, Japan was also damaged by a series of typhoons that has put the station out of commission. Repairs are underway.

Major reductions in the NASA SLR budget for the fiscal year 2004 have also had a deleterious effect on the amount and distribution of ranging data, an impairment that could not be counterbalanced by operational improvements at other tracking stations. The SLR stations Maui and Arequipa were closed. This, coupled with reductions at GSFC and the MLRS, and some technical problems at the Tahiti station, have left us with a large uncovered region in the Pacific. Efforts are underway at NASA to reopen the station in Arequipa and reconstitute the station at Maui with the TLR5-4.

The first kilohertz SLR system in the network became fully operational at the Graz station. The ranging data is very impressive, with excellent quality and quantity, even out to GPS and other high satellites. The Graz team gave an excellent demonstration of the capabilities of this new system during the workshop on kilohertz ranging in October 2004.

Other highlights from the network included final acceptance testing of the Matera 1.8 m telescope and ranging system, initial tracking experiments with the SLR 2000 system at NASA, upgrade of the Beijing SLR system, and the preparation of the new Chinese SLR system for deployment at the San Juan observatory in Argentina.

Several new satellites have been added to the ILRS tracking roster during this period. The Larets spherical retroreflector satellite, to support technology development, and the Gravity Probe B mission, to support geodynamics and relativity programs, are being tracked by the network. The ICESat mission is being supported by a subnetwork of ILRS stations, selected through careful procedures, to ensure the safety of vulnerable onboard optical detectors. It is anticipated that careful procedures for satellites with sensitive onboard systems will play a more significant role on the ILRS activities in the future.

The ILRS Analysis Working Group has evaluated its Pilot Project submissions for "Position and EOP" and chosen the Agenzia Spaziale Italiana (ASI) as its primary combination center for the official ILRS analysis product for the International Earth Rotation and Reference Systems Service (IERS). The Deutsches Geodätisches Forschungs Institut (DGFI) was selected as the alternate. Work continues on other pilot projects and on the implementation of a new refraction model to better represent lower elevation conditions. The other ILRS Working Groups have also made significant progress during this reporting period. The Networks and Engineering Working Group has initiated a program to improve daylight ranging and network engineering files. The Data Formats and Procedures Working Group is developing a new prediction format to cover operations at extended ranges. The Missions Working Group has been developing operational procedures for payloads with sensitive optical detectors aboard. The Signal Processing Ad Hoc Working Group is developing a comprehensive web based file on center-of-mass corrections for the retroreflector satellites.

---

The Fourteenth International Workshop on Laser Ranging was held in San Fernando, Spain in June 2004. This workshop followed in the long tradition of providing a venue for presentations and valuable discussions on scientific application, engineering, operations and data handling. We extend our appreciation to the Real Instituto y Observatorio de la Armada and the San Fernando SLR team for their wonderful hospitality.

I would like to thank all of our colleagues from the tracking network, at the Central Bureau, the Analysis and Data Centers, and those who undertook additional duties in our working groups, for their continuous contribution to our Service. Special thanks goes to the agencies, institutions and foundations for their ongoing financial support.

Werner Gurtner  
ILRS Governing Board Chairperson  
Astronomical Institute  
Bern, Switzerland



---

# SECTION 1 ABOUT ILRS



"FRASER PRINCIPLES"





# SECTION 1

---

## ILRS ORGANIZATION

### **The Mission of the ILRS**

*Michael Pearlman/CfA*

The International Laser Ranging Service (ILRS) organizes and coordinates Satellite Laser Ranging (SLR) and Lunar Laser Ranging (LLR) to support programs in geodetic, geophysical, and lunar research activities and provides the International Earth Rotation and Reference Systems Service (IERS) with products important to the maintenance of an accurate International Terrestrial Reference Frame (ITRF). This reference frame provides the stability through which systematic measurements of the Earth can be made over thousands of kilometers, decades of time, and evolution of measurement technology. The ILRS is one of the technique services of the International Association of Geodesy (IAG).

### **The Role of the ILRS**

- Coordinates activities for the international network of SLR stations;
- Develops the standards and specifications necessary for product consistency;
- Develops the priorities and tracking strategies required to maximize network efficiency;
- Collects, merges, analyzes, archives and distributes satellite and lunar laser ranging data to satisfy user needs;
- Provides quality control and engineering diagnostics to the global network;
- Works with new satellite missions in the design and building of retroreflector targets to maximize data quality and quantity;
- Works with science programs to optimize scientific data yield; and
- Encourages the application of new technologies to enhance the quality, quantity, and cost effectiveness of its data products

### **ILRS Data Products**

- Scale (GM) and time-varying Earth Center of Mass for the ITRF
- Static and time-varying coefficients of the Earth's gravity field
- Earth orientation: polar motion and length of day
- Long-term time history of three dimensional station positions
- Accurate satellite ephemerides for precise orbit determination (POD) and validation of altimetry, relativity, and satellite dynamics
- Backup POD for other missions

### **The Structure of the ILRS**

- Forty tracking stations that provide ranging data on an hourly basis
- Three operations centers that collect and verify the satellite data and provide the stations with sustaining engineering, communications links, and other support

- Two global data centers that receive and archive data and supporting information from the operations centers, provide these data to the analysis centers, and receive and archive ILRS scientific data products from the analysis centers and provide them to the users
- Three analysis centers, 21 associate analysis centers, and four lunar analysis centers that support the ITRF and routinely produce data products for the user community and provide a second level of data quality assurance in the network
- Five ILRS working groups that provide technical expertise and help formulate policy
- ILRS Central Bureau that is responsible for the daily coordination and management of ILRS activities including communications and information transfer, monitoring and promoting compliance with ILRS network standards, monitoring network operations and quality assurance, maintaining documentation and databases, and organizing meetings and workshops
- Governing Board which is responsible for general direction, defining official ILRS policy and products, determining satellite-tracking priorities, developing standards and procedures, and interacting with other services and organizations

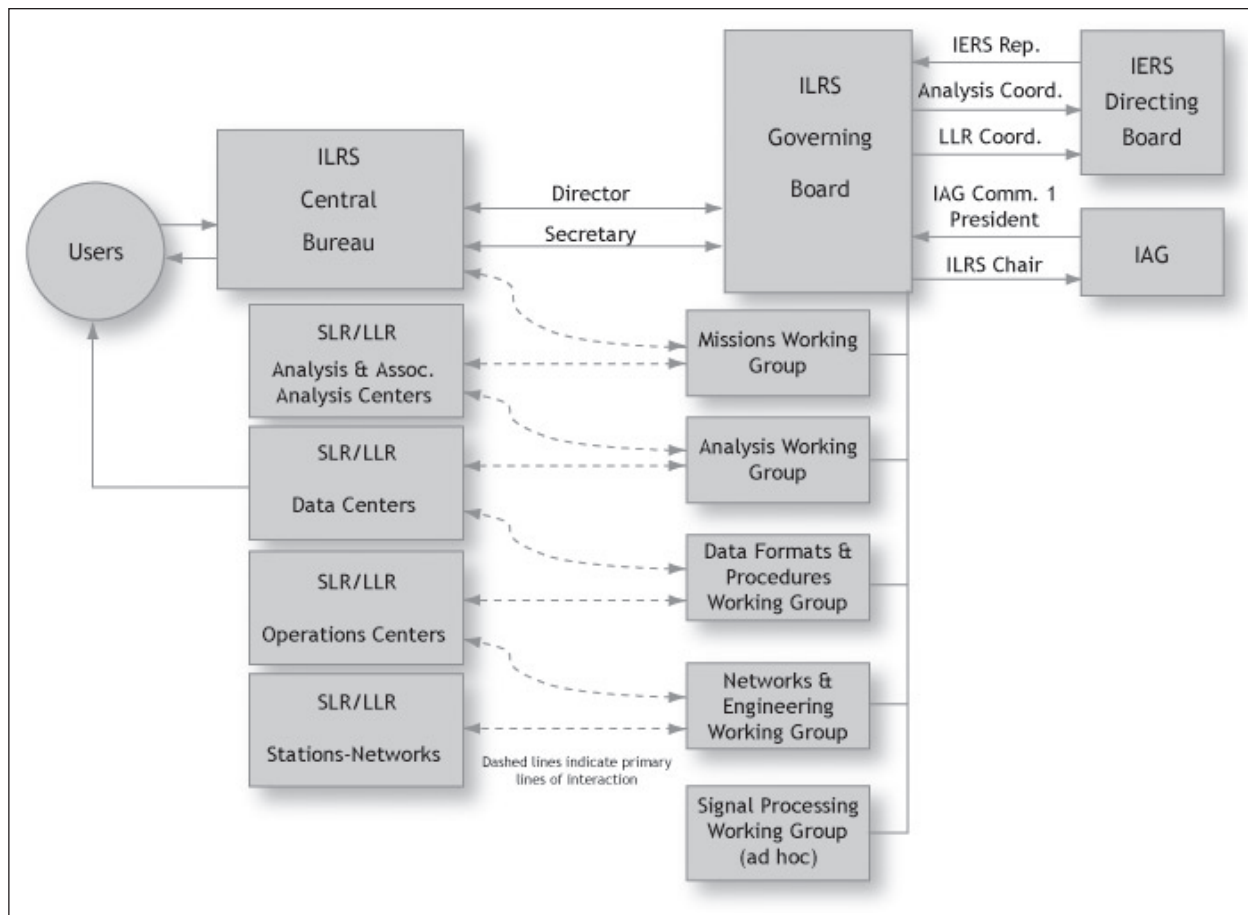

Figure 1-1. ILRS organization.

## ILRS Information and Outreach

The ILRS Central Bureau maintains a comprehensive Web site as the primary vehicle for the distribution of information within the ILRS community. The site, which can be accessed at: <http://ilrs.gsfc.nasa.gov> is also available at a mirrored site at the European Data Center (EDC) in Munich.



# ILRS GOVERNING BOARD



**Name:** Graham Appleby  
**Position:** Analysis Center Representative  
**Affiliation:** Natural Environmental Research Center (NERC) Space Geodesy Facility (NSGF), UK

**Name:** Ben Greene  
**Position:** WPLTN Network Representative  
**Affiliation:** EOS Pty. Ltd., Australia



**Name:** Giuseppe Bianco  
**Position:** EUROLAS Network Representative  
**Affiliation:** Agenzia Spaciale Italiana (ASI), Italy

**Name:** Werner Gurtner  
**Position:** Chairman and EUROLAS Network Representative  
**Affiliation:** Astronomical Institute, University of Bern, Switzerland



**Name:** David Carter  
**Position:** NASA Network Representative  
**Affiliation:** NASA Goddard Space Flight Center, USA

**Name:** Georg Kirchner  
**Position:** At Large Representative  
**Affiliation:** Austrian Academy of Sciences, Austria



**Name:** Herman Drewes  
**Position:** Ex-Officio, President of IAG Commission 1  
**Affiliation:** Deutsches Geodätisches Forschungsinstitute, Germany

**Name:** Hiroo Kunimori  
**Position:** WPLTN Network Representative  
**Affiliation:** National Institute of Information and Communications Technology (NICT), Japan



ILRS Governing Board (continued)



**Name:** Jan McGarry  
**Position:** NASA Network Representative  
**Affiliation:** NASA Goddard Space Flight Center, USA

**Name:** Ulrich Schreiber  
**Position:** At-Large Representative  
**Affiliation:** Technische Universitaet Muenchen, Germany



**Name:** Carey Noll  
**Position:** Ex-Officio, Secretary, ILRS Central Bureau  
**Affiliation:** NASA Goddard Space Flight Center, USA

**Name:** Bob Schutz  
**Position:** IERS Representative to ILRS  
**Affiliation:** University of Texas, USA



**Name:** Ron Noomen  
**Position:** Analysis Center Representative  
**Affiliation:** Delft University of Technology, The Netherlands

**Name:** Wolfgang Seemueller  
**Position:** Data Center Representative  
**Affiliation:** Deutsches Geodätisches Forschungsinstitute, Germany



**Name:** Michael Pearlman  
**Position:** Ex-Officio, Director, ILRS Central Bureau  
**Affiliation:** Harvard-Smithsonian Center for Astrophysics, USA

**Name:** Peter Shelus  
**Position:** Lunar Representative  
**Affiliation:** University of Texas, USA







---

# SECTION 2

## ILRS TRACKING NETWORK



ILRS TRACKING NETWORK





# SECTION 2

---

## ILRS TRACKING NETWORK

### **Satellite Laser Ranging (SLR) Network**

*Michael Pearlman/CfA*

The SLR technique is now forty years old, having originated in 1964 with ranging to Beacon-B from GSFC. Systems have evolved from a manually operated mount with meter-level ranging systems to automated and semi-autonomous systems with sub-centimeter ranging accuracies.

The ILRS network, as shown in Figure 2-1, has grown continuously through the years, involving forty stations in 23 countries in 2003-2004. For the first time, however, the network has experienced reductions in capabilities. SLR budget reductions by NASA in 2003 have had a very profound effect on the ILRS network. Arequipa has been closed temporarily; efforts are currently underway to reopen it. Faced with reductions, the University of Hawaii closed the HOLLAS station and the building has been raised to make room for another project. Discussions are underway for an alternative SLR program at Mt Haleakala based temporarily on TLRs-4 and eventually SLR2000. Significant staffing reductions have also been imposed at MLRS (McDonald) and MOBLAS-7 (GSFC) and to a lesser extent at MOBLAS-4 (Monument Peak). The partner stations at Yarragadee, Hartebeesthoek, and Tahiti are unaffected.

A forest fire destroyed the Mt. Stromlo station in early 2003. The station has been rebuilt and is now in full operation. Congratulations to the EOS/Geoscience Australia team in getting the station back on the air so quickly after such a devastating event. The French Transportable Laser System (FTLRS) operated in Chania, Crete during 2003 as part of the European GAVDOS Project and to support altimetry calibration for Jason, TOPEX, and Envisat. FTLRS completed a collocation at San Fernando in mid-2004 and was moved to Brest, France where the system participated in a multi-techniques project to measure loading effects of ocean tides on Earth's crust. The Graz SLR station implemented the first two kHz operations in the ILRS network with very impressive results in terms of data yield, accuracy and reliability. See the Emerging Technologies section for more information about kHz ranging. The TIGO system in Concepción, Argentina and the upgraded Zimmerwald station have had some success with their two-wavelength operation using a titanium-sapphire laser operating at 423 nm and 846 nm. Unfortunately the weather conditions at Concepción have been much worse than expected and the data yield has been considerably lower than anticipated.

The Chinese SLR network continues to support the ILRS with the Changchun station being one of the more prolific in the international network. The Beijing and Shanghai stations continue to track on a regular basis. Construction continues on the new Shanghai station located at an observatory outside of town where clearer weather prevails; relocation, now scheduled for early 2005, should improve data yield considerably. The Beijing Observatory continues its preparation of an SLR system scheduled for installation at the San Juan Observatory in Argentina in early 2005. The GUTS facility in Tanegashima Japan began operations in 2004 but was hit by six typhoons during the year and has suffered from problems relating to the storm damage. A leak in the dome roof has caused serious damage to the dome shutter, which prevents remote operation; the JAXA staff hopes to have the system operational again in early 2005.

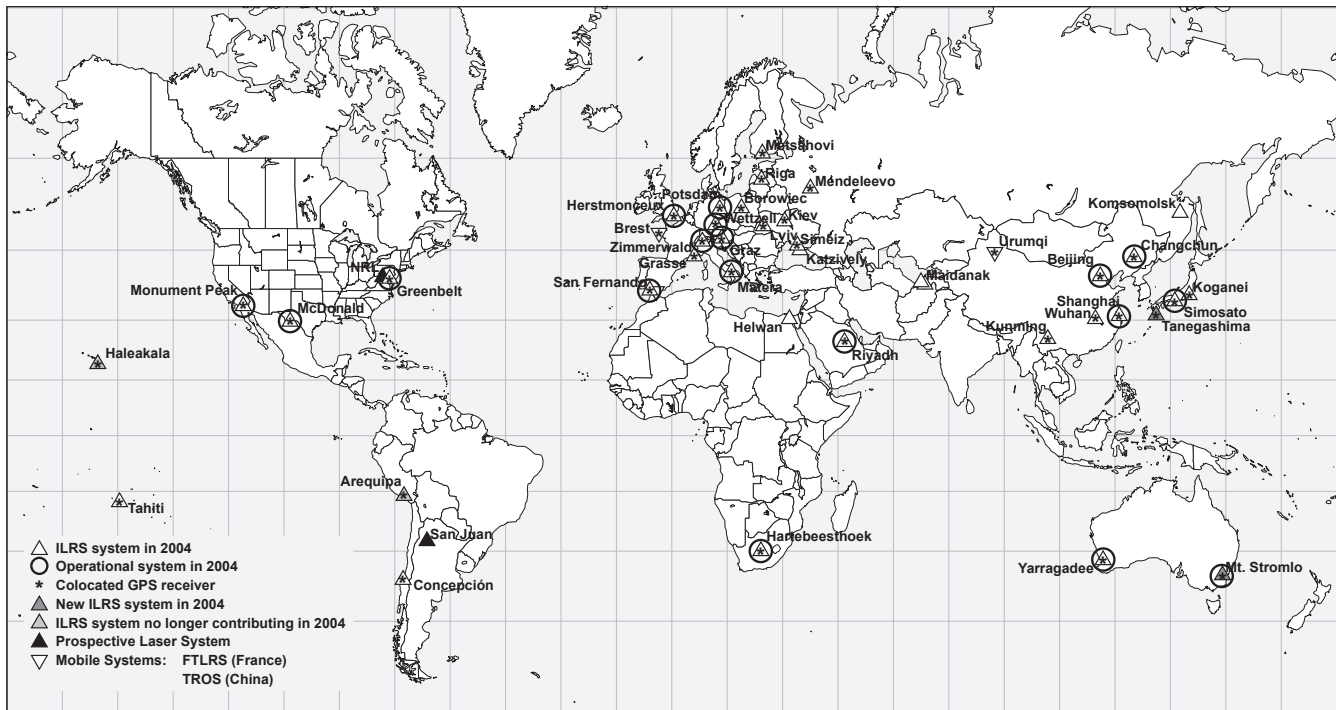

Figure 2-1. ILRS tracking network in 2004.

## Lunar Laser Ranging (LLR) Network

*Peter Shelus/CSR*

Lunar laser ranging (LLR) is one of the more modern and exotic forms of astrometry. It measures the round-trip travel time of a laser pulse that is emitted from a station on the Earth and returns, after being reflected off of a retroreflector array on the Moon. The analysis of this constantly changing distance, using several stations on the Earth and several retroreflectors on the Moon, provides a diversity of terrestrial, lunar, solar system, and relativistic results. After almost 40 years of operation, LLR remains a technically challenging task. With several tens of highly efficient artificial satellite ranging stations around the world, only two of them have the capability of routinely ranging to the Moon.

The data that is gathered by the LLR stations form a foundation upon which a large number of astronomical disciplines rely. They provide a valuable multi-disciplinary analytical tool, the benefits of which are registered in such areas as the solid Earth sciences, geodesy and geodynamics, Solar System ephemerides, terrestrial and celestial fundamental reference frames, lunar physics, general relativity and gravitational theory. They contribute to our knowledge of the precession of the Earth's spin axis, the 18.6 year lunar induced nutation, polar motion and Earth rotation, the determination of the Earth's obliquity to the ecliptic, the intersection of the celestial equator and the ecliptic (the equinox), lunar and solar solid body tides, lunar tidal deceleration, lunar physical and free librations, as well as energy dissipation in the lunar interior. They determine Earth station and lunar surface retroreflector location and motion, the Earth-Moon mass ratio, lunar and terrestrial gravity harmonics and Love numbers, relativistic geodesic precession and the strong equivalence principle of general relativity.

The LLR network consists of the Observatoire de la Cote d'Azur (OCA) station in France and the McDonald Laser Ranging Station (MLRS) in the USA. Both stations operate in a multiple target mode, observing SLR targets in addition to the lunar surface retroreflectors. The Matera Laser Ranging Observatory (MLRO) is also a joint SLR/LLR station. However, it is not operating in a routine sense for LLR. There are no LLR data reported by the Wettzell SLR station in Germany.

There is additional LLR-related activity going in the United States at the Apache Point Observatory in New Mexico. Work is progressing on the implementation of a completely new LLR station. A 3.5-m telescope and 1 arc second image quality at their site should produce a high photon-rate regime, able to achieve millimeter precision. The multi-Institution research group continues its effort, but we are unsure as to when they will be operational.

MLRS and OCA LLR data are made available through the normal data centers of the ILRS. Funding for both stations remains fragile. Including other SLR targets in the routine OCA observing program allows the station to compensate with additional support from the national space program. With the MLRS there have been no recent upgrades or improvements; activity is directed toward keeping the station operational and in a data-gathering mode.

## Network Performance

### *Carey Noll/GSFC and Mark Torrence/RITSS*

Network Performance Report Cards are issued quarterly by the ILRS Central Bureau. These reports tabulate the previous 12 months of data quality, quantity, and operational compliance by station and can be found on the ILRS Web site (at [http://ilrs.gsfc.nasa.gov/stations/site\\_info/global\\_report\\_cards/index.html](http://ilrs.gsfc.nasa.gov/stations/site_info/global_report_cards/index.html)) along with established guidelines for station performance. As shown in Figures 2-2, 2-3, and 2-4, network data yield has dropped in the past two years due mainly to reduction in NASA network support.

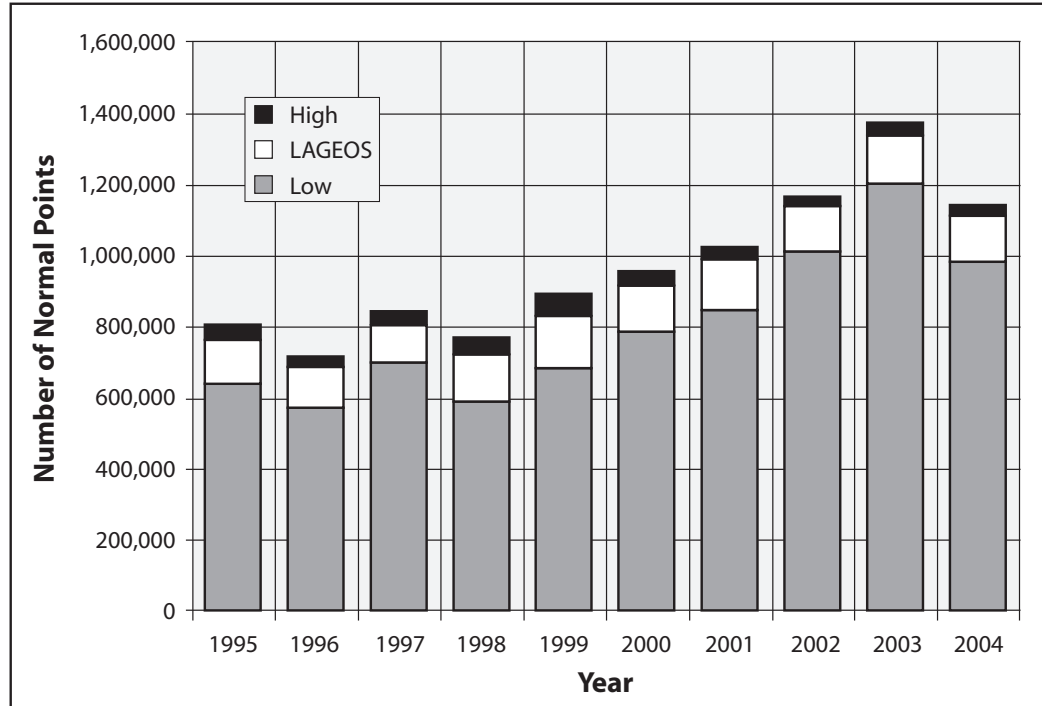

*Figure 2-2. Network data yield continued to increase with improved automation and new satellites through 2003; network reductions cut data yield in 2004.*

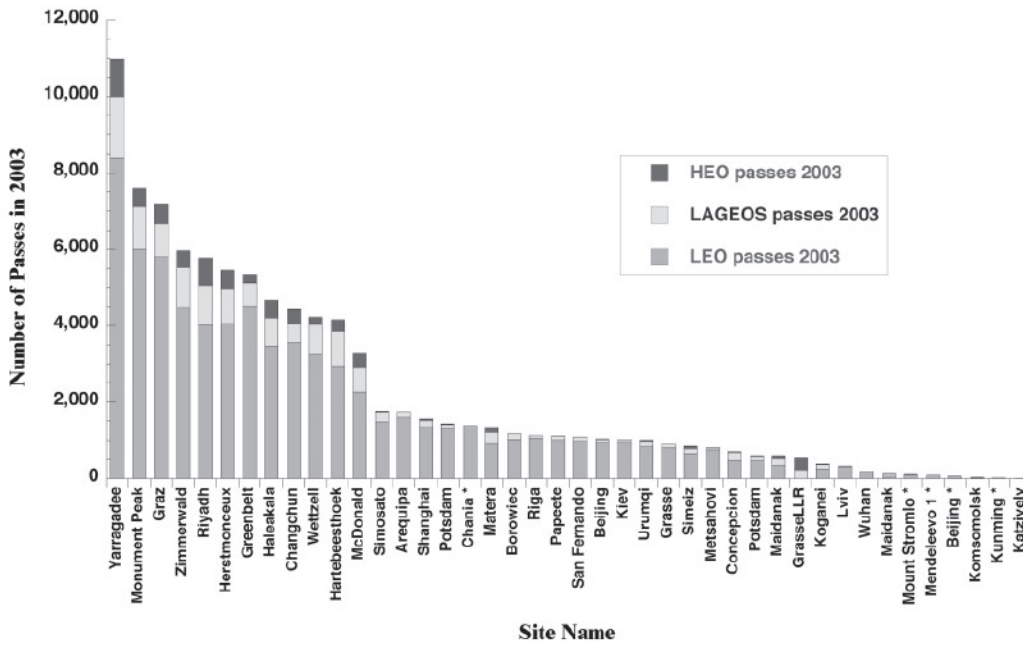

Figure 2-3a. Number of passes tracked from January 2003 through December 2003.  
\* station tracked in only in 2003

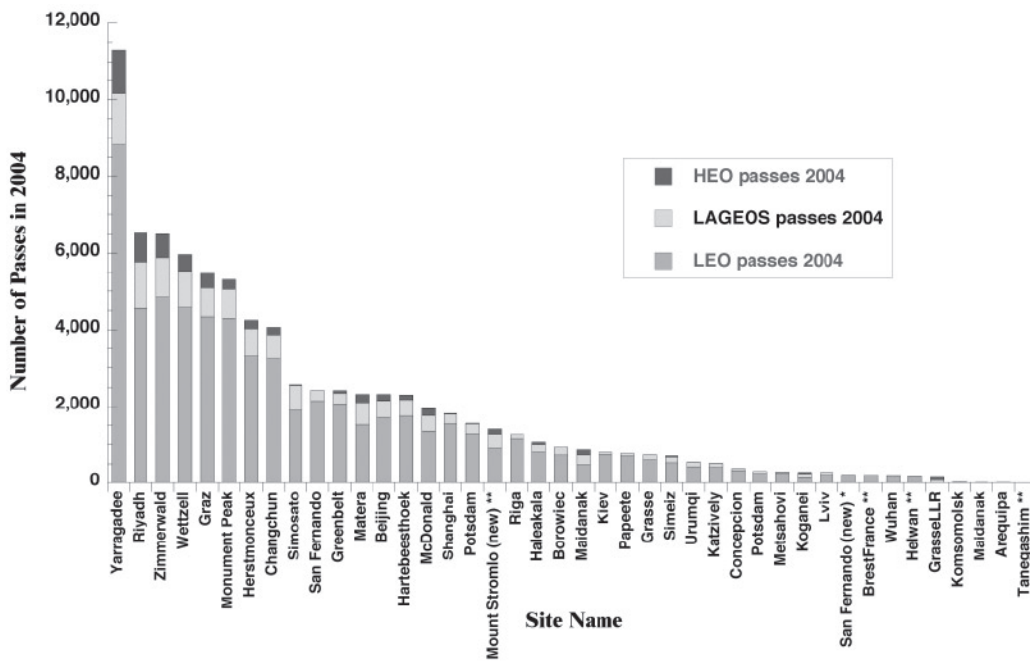

Figure 2-3b. Number of passes tracked from January 2004 through December 2004.  
\*\* station began tracking in 2004

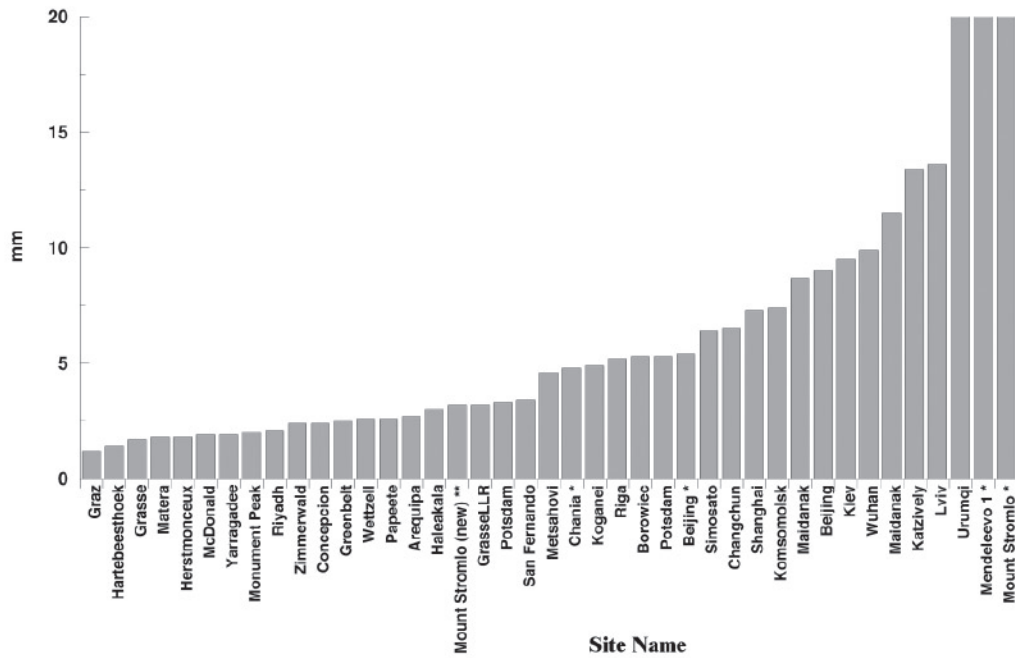

Figure 2-4. Average normal point precision in mm for data from January 2003 through December 2004 as calculated by the National Institute of Information and Communications Technology (NICT), Japan.

## Site Surveys and Collocation Sites

*Zuheir Altamimi/IGN and Michael Pearlman/CfA*

The Terrestrial Reference Frame is the means by which we connect measurements over space, time and evolving technologies. Space may be ten thousand kilometers. Time will be decades and probably generations. Evolving technologies are the changes in the ground systems and the satellites that will happen as measurement capabilities improve. If we are going to see change in the Earth and its environment, we need the long-term stability of the reference frame.

Satellite Laser Ranging (SLR) is one of the fundamental geodetic techniques (along with GPS, VLBI, and DORIS) that define and maintain the Terrestrial Reference System. Each technique is fundamentally different; each has its own unique strengths and its own systematic errors. We can exploit the strengths and mitigate the systematic errors through the co-location of space techniques (SLR, GPS, VLBI, and DORIS) at common sites. This is an essential part in our achievement of the high-accuracy Terrestrial Reference Frame.

Site surveys between collocated instruments are a basic, but often unappreciated aspect in the development of the reference frame. The value of sub-centimeter measurements across intercontinental distances can be lost through missing or inaccurate local ties, inconsistencies in ground survey techniques, poor survey control network geometry and monumentation, improper analysis of survey data, and lack of proper documentation.

### Current Status of the Collocation Sites

The VLBI and SLR networks each include less than fifty sites. The DORIS network is more homogeneous and includes 56 sites. The IGS GPS network contains more than 350 permanent sites. In the worldwide Space Geodesy Network, 59 sites host two observing techniques (SLR, GPS, VLBI, and/or DORIS); only thirteen sites have three, and three sites have four.

The status of site collocations with SLR is show in Figure 2-5 and Table 2-1. There are currently only three SLR sites operating with SLR, GPS, VLBI, and DORIS, and ten SLR sites operating with GPS and VLBI. Seven are collocated with DORIS. All of the SLR sites in the ILRS operational network are collocated with GPS; six of the other participating SLR stations do not have GPS. The distribution of these collocated sites is not well placed and in some cases operations of one or more of the techniques is marginal. Local surveys are also an issue at nine of the SLR collocated sites.

Collocation of techniques and measurement and monitoring of local inter-technique vectors to the mm level must continue to be a high priority with the SLR network.

### New Surveys

During this period, The Institut Géographique National (IGN), France and NASA GSFC participated in complete surveys of the following co-location sites:

- Hartebeesthoek, South Africa, comprising the four techniques: VLBI, SLR, GPS and DORIS
- Shanghai, China, comprising three techniques: VLBI, SLR and GPS
- Wuhan, China, comprising three techniques: VLBI, SLR and GPS

The adjustment of these three surveys is currently underway and the complete output, including final report and SINEX files, anticipated in mid-2005. Full information will posted at the ITRF Web site <http://itrf.ensg.ign.fr/>.



NASA is planning a survey of the Mt. Haleakala site in early 2005 to secure the survey information for the now closed HOLLAS station and prepare for the installation of the TLRS-4.

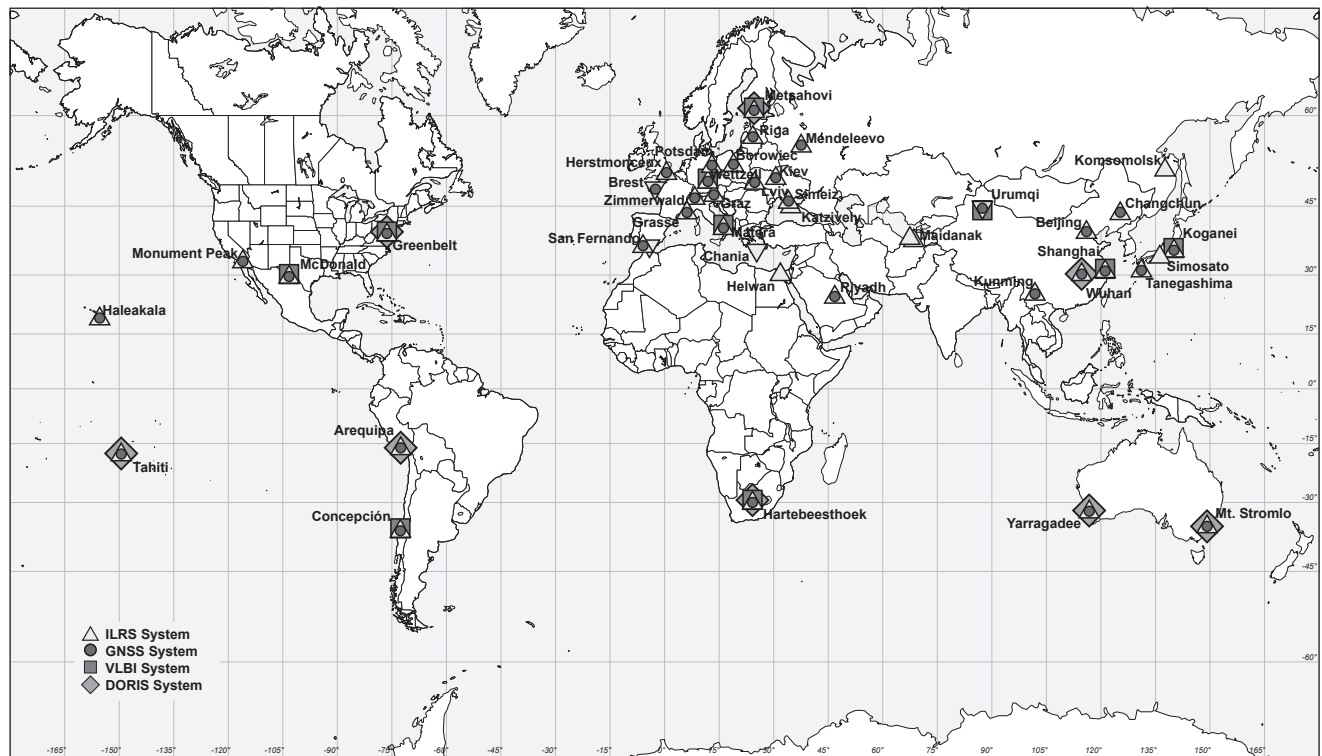

Figure 2-5. Current SLR co-locations with GNSS, VLBI, and DORIS.

Table 2.1. Space Techniques Collocated with SLR (2003-2004)

Site Name	Country	GNSS	VLBI	DORIS	PRARE
Arequipa	Peru	X		X	
Beijing	China	X			X
Borowiec	Poland	X			X
Brest <sup>1</sup>	France	X			X
Changchun <sup>2</sup>	China	X			
Chania <sup>1</sup>	Greece				
Concepcion <sup>2</sup>	Chile	X	X		X
Grasse	France	X			X
Graz	Austria	X			X
Greenbelt, MD	USA	X	X	X	X
Haleakala, HI <sup>2</sup>	USA	X			
Hartebeesthoek	South Africa	X	X	X	X
Helwan	Egypt				
Herstmonceux	UK	X			
Katzively	Ukraine				
Kiev	Ukraine	X			
Koganei <sup>2</sup>	Japan	X	X		
Komsomolsk	Russia				
Kunming <sup>2</sup>	China	X			X
Lviv <sup>2</sup>	Ukraine	X			
Maidanak	Russia				
Matera	Italy	X	X		X
McDonald, TX	USA	X	X		
Mendeleevo	Russia	X			
Metsahovi	Finland	X	X	X	X
Monument Peak, CA	USA	X			
Mount Stromlo	Australia	X		X	X
Potsdam	Germany	X			X
Riga	Latvia	X			X
Riyadh <sup>2</sup>	Saudi Arabia	X			
San Fernando	Spain	X			
Shanghai	China	X	X		
Simeiz	Ukraine	X			
Simosato	Japan				
Tahiti	F. Polynesia	X		X	X
Tanegashima <sup>2</sup>	Japan	X			
Urumqi <sup>1</sup>	China	X	X		
Wetzell	Germany	X	X		X
Wuhan	China	X		X	X
Yarragadee	Australia	X		X	

---

# SECTION 3

## MISSIONS AND CAMPAIGNS





# SECTION 3

## MISSIONS AND CAMPAIGNS

Michael Pearlman/CfA

### Current Missions

During 2003-2004, the ILRS supported 31 artificial satellite missions including passive geodetic (geodynamics) satellites, Earth remote sensing satellites, navigation satellites, and engineering missions. The stations with lunar capability also tracked the lunar reflectors. Missions were added to the ILRS tracking roster as new satellites are launched and as new requirements were adopted (see Figure 3-1). Missions for completed programs were deleted. Over the last two years, several new satellites were added to the ILRS tracking roster as listed in Table 3-1.

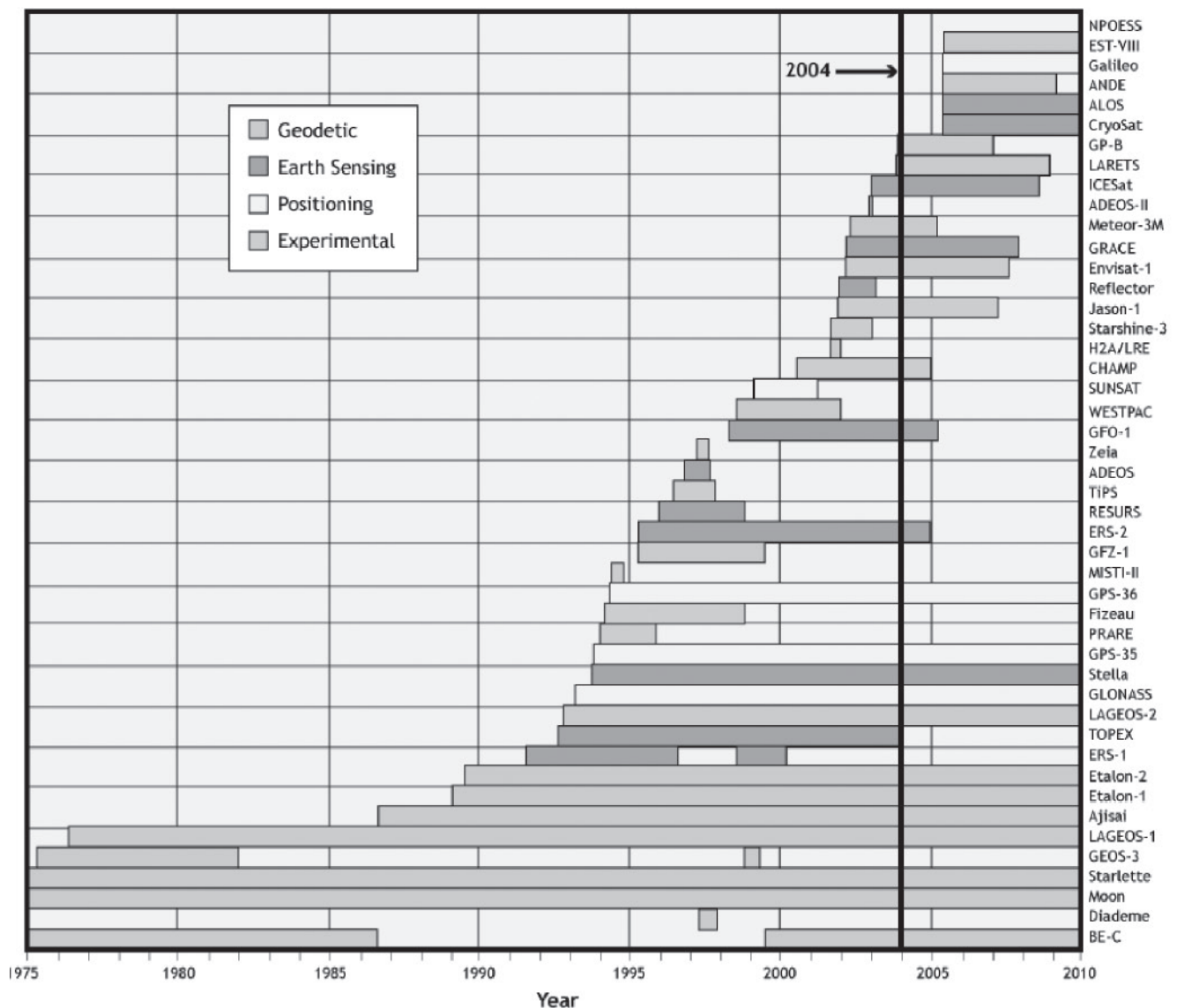

Figure 3-1. SLR mission tracking timeline.

**Table 3-1. New Missions in 2003-2004**

<b>Mission</b>	<b>Launch date</b>	<b>Sponsor</b>	<b>Application</b>	<b>ILRS Mission Support Status</b>
ADEOS-2	14-Dec-2002	JAXA	Microwave and optical sensing of the environment.	One month of tracking by the network; limited tracking after launch with advanced approval only.
ICESat	13-Jan-2003	NASA	Altimetry satellite to study relative ice and ocean surface mass balance	Validation of GPS POD, back-up POD, orbit maintenance; tracking limited to a small subnetwork only.
GP-B	20-Apr-2004	NASA, Stanford U.	Relativity experiment through precise gyroscope measurements	POD with GPS

**ADEOS-2**

The ADvanced Earth Observing Satellite 2 (ADEOS-2), as a follow-on for ADEOS-1, is a three-year mission to monitor the water and energy cycle as part of the global climate system and to estimate biomass productivity as part of the carbon cycle. ADEOS-2 used SLR tracking during its first month of flight to support gravity field modeling and validation for subsequent precision orbit determination. SLR tracking ended 34 days after launch to avoid damage to the ADEOS-2 optical sensors that are sensitive to the laser radiation at 537 nm.

ADEOS-2 includes an advanced microwave scanning radiometer, a global imaging system, a limb atmospheric spectrometer, sea winds, and Earth reflectance polarization and directionality measurement system.

The corner cubes array is identical to that of GFO-1. The cubes are symmetrically mounted on a hemispherical surface with one nadir-looking corner cube in the center, surrounded by an angled ring of eight corner cubes. This gives a laser ranging field of view angles of 360 degrees in azimuth and 60 degrees elevation around the nadir axis.

For more information on ADEOS-2 see <http://god.tksc.nasda.go.jp/ad2/adeos2.html>.

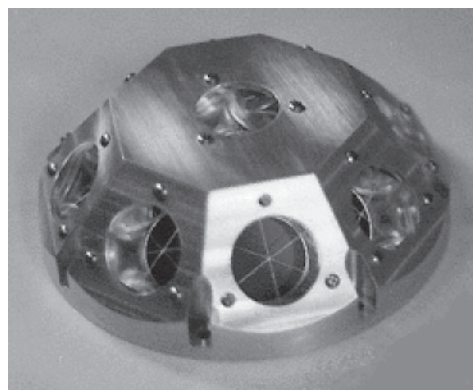
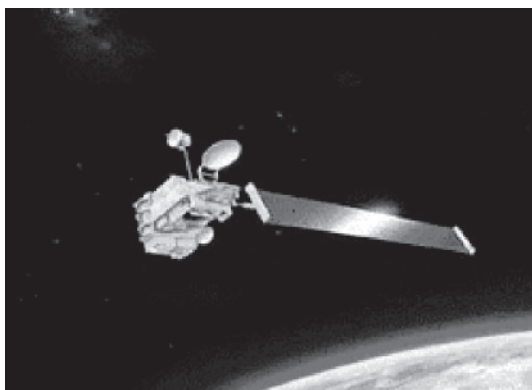

Figure 3-2. ADEOS-2 satellite (from JAXA Web site). Figure 3-3. ADEOS-2 array (from JAXA Web site).

## **ICESat**

The Ice, Cloud, & land Elevation SATellite (ICESat) is part of NASA's Earth Observing System (EOS) program, which includes a series of satellites beginning in 1998 to measure the Earth's atmosphere, oceans, land, ice, and biosphere.

ICESat was launched to study the mass balance of the polar ice sheets and their contributions to global sea level change, the vertical structure of clouds and aerosols in the atmosphere, and to map the topography of land surfaces. The primary instrument onboard ICESat is the Geoscience Laser Altimeter System (GLAS) which is measuring ice-sheet topography to a precision of 10 cm. The height measurement relies on accurate knowledge of spacecraft radial orbit position. SLR is being used for validation of the altimeter calibration and the GPS precision orbit determination (POD), back-up POD, and orbit maintenance.

The ICESat retroreflector array design is identical to that of GFO-1. With the sensitivity of the GLAS altimeter to laser radiation at 537 nm, careful scheduling, angular restrictions, and station selection have been imposed on the tracking activity (see section 5).

For more information on ICESat see: <http://icesat.gsfc.nasa.gov/>.

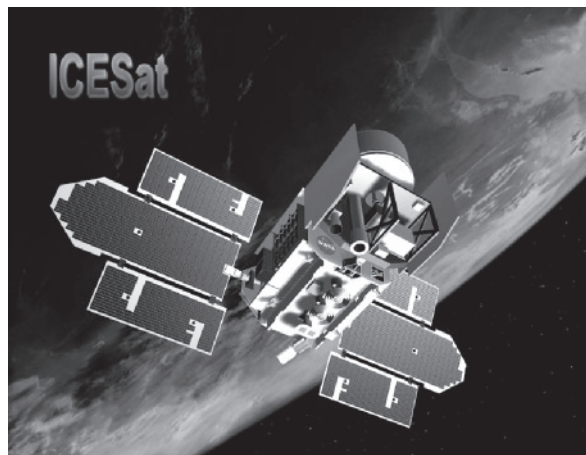

Figure 3-4. ICESat satellite (from Ball Aerospace Web site).

## **Gravity Probe-B**

Gravity Probe-B (GP-B) is a relativity experiment developed by NASA and Stanford University to test two predictions of Einstein's general theory of relativity.

The experiment is checking, very precisely, for tiny changes in the direction of spin of four gyroscopes contained in the satellite, orbiting at 400-mile altitude directly over the poles. A telescope protruding from the back of the satellite remains oriented toward a guide star (IM Pegasi) to maintain precise orientation in the inertial reference frame. The gyroscopes measure how space and time are warped by the presence of the Earth, and how the Earth's rotation drags space-time around with it. These effects, though small for the Earth, have far-reaching implications for the nature of matter and the structure of the Universe.

Satellite laser ranging is used in conjunction with GPS data to determine a precision orbit. The retroreflector array is identical to that on GFO-1.

For more information see: <http://einstein.stanford.edu/>.

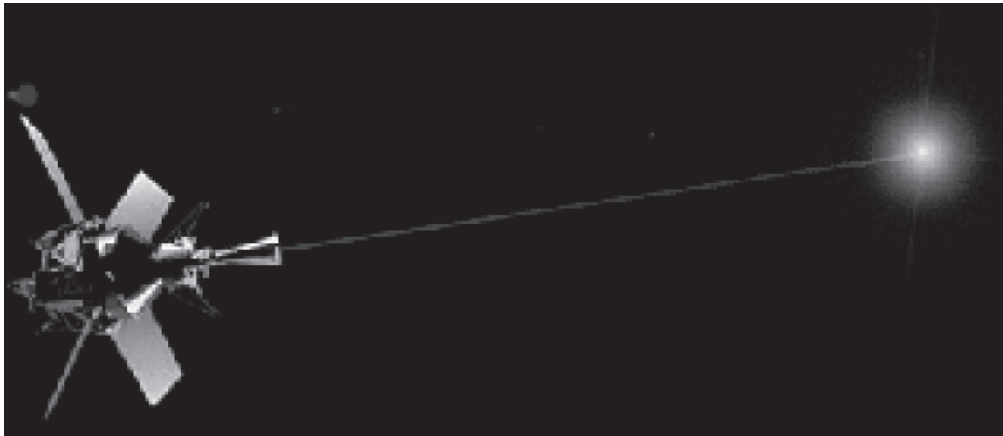

Figure 3-5. GP-B satellite (from Stanford University Web site).

## Future Missions

A number of new missions, shown in Table 3-2, requiring SLR support for POD and instrument calibration and validation, are scheduled for launch over the next two years.

Table 3-2. New Missions Requesting SLR Support

Mission	Sponsor	Scheduled Launch	Altitude (km)	Inclination (degrees)	Application
Cryosat	ESA	Early 2005	720	92°	Ice surface altimetry to study changes in ice thickness
ALOS	JAXA	Late 2005	692	98.16°	Microwave and optical sensing of the environment
Galileo	ESA	2005	23,916	56°	Radio navigation satellite system
ETS-VIII	JAXA	2005	36,000	0°	Test of new geosynchronous satellite bus
OICETS	JAXA	August 2005	610	97.83°	Optical communications
ANDE	NRL	2006	335	51.6°	Dynamic calibration of atmospheric models
GOCE	ESA	2006	250	96.5°	Earth's gravity field and geoid modeling
NPOESS	NOAA, NASA, DoD	2013	833	98.7°	Sea surface height

### Cryosat

Cryosat is a three-year radar altimetry mission, scheduled for launch in early 2005, to determine variations in the thickness of the Earth's continental ice sheets and marine ice cover. Its primary objective is to test the prediction of thinning arctic ice due to global warming. The satellite will use an advanced SAR/Interferometric Radar Altimeter (SIRAL) combined with precise orbit determination, which will be furnished by the combination of DORIS and SLR. SLR will support both POD and calibration of the altimeter. The retroreflector array on Cryosat uses the ERS/Envisat design.

More details on the mission can be found at: <http://www.esa.int/export/esaLP/cryosat.html>.





Figure 3-6. Cryosat (from ESA Web site).

## ***ALOS***

The Advanced Land Observing Satellite (ALOS) will perform high-resolution observations of the earth's surface to assist in the process of compiling very detailed maps of the Pacific Rim region. ALOS will also be used to monitor disasters for environmental protection and for maintaining and developing Earth observation technology. ALOS is scheduled for launch in late 2005.

The data from three remote-sensing instruments on ALOS, (1) PRISM, (2) AVNIR-2 and (3) PALSAR, are combined to develop digital elevation models to make topographic maps for studies of crustal motion, regional deformation, earthquake and disaster monitoring, and resource survey and exploration. PRISM is a panchromatic radiometer with 2.5-meter spatial resolution. To obtain elevation data, PRISM has three optical systems for forward, nadir, and backward viewing. AVNIR-2 is a visible and near-infrared radiometer for observing land and coastal zones and provides better spatial resolution than the previous ADEOS AVNIR. It will be used to provide land coverage maps and land-use classification maps for monitoring regional environment. The instrument also has a cross track pointing capability for disaster monitoring. PALSAR is an active microwave sensor for cloud-free, day-and night land observation and provides higher performance than the JERS-1 SAR. It has a beam steerable in elevation and the ScanSAR mode, which can provide a wider swath than the conventional SAR. The development of PALSAR is a joint project between NASDA and the Japan Resources Observation System Organization (JAROS).

GPS and SLR will be used for POD. The retroreflector array design is similar to the ERS-1 and Envisat arrays. It is optimized for the green wavelength (532 nanometers). The corner cubes are symmetrically mounted on a hemispherical surface with one nadir-looking corner cube in the center, surrounded by an angled ring of eight corner cubes. This will allow laser ranging in the field of view angles of 360 degrees in azimuth and 60 degrees elevation around the axis of the array.

With the vulnerability of both the PRISM and AVNIR-2 radiometers to the SLR radiation special precautions will be taken to protect the onboard systems. Additional information can be found in the Restricted Tracking on Satellites with Vulnerable Systems (see Section 5).

Information on the array (shown in Figure 3-6) can be found on the JAXA ALOS RRA page at <http://god.tksn.nasda.go.jp/al/lrra/main.html>; more information about the ALOS mission can be found on the Web site [http://www.jaxa.jp/missions/projects/sat/eos/alos/index\\_e.html](http://www.jaxa.jp/missions/projects/sat/eos/alos/index_e.html).



Figure 3-7. ALOS retroreflector array (from JAXA Web site).

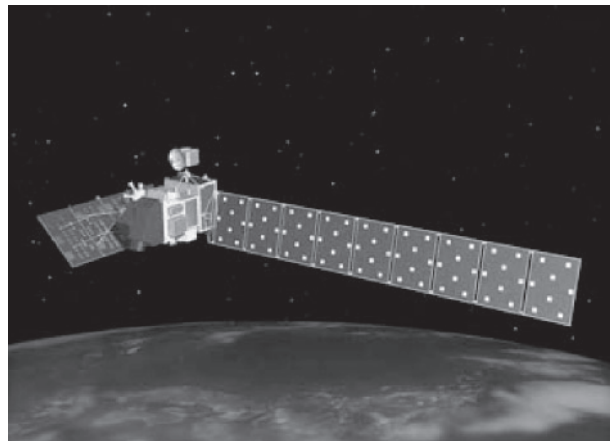

Figure 3-8. ALOS satellite (from JAXA Web site).

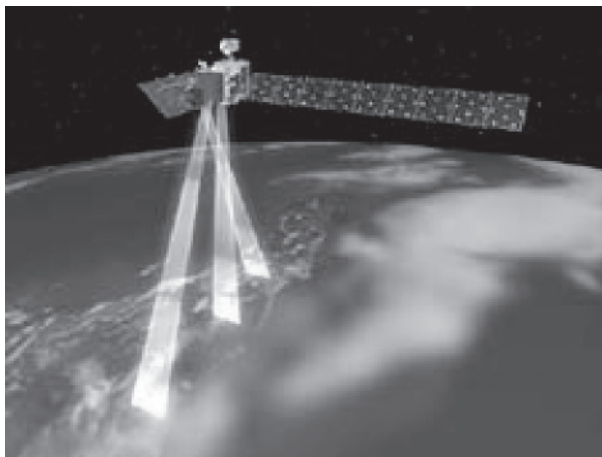

Figure 3-9. ALOS with PRISM Optical Radiometer sweeping forward, aft, and side-to-side (from JAXA Web site).

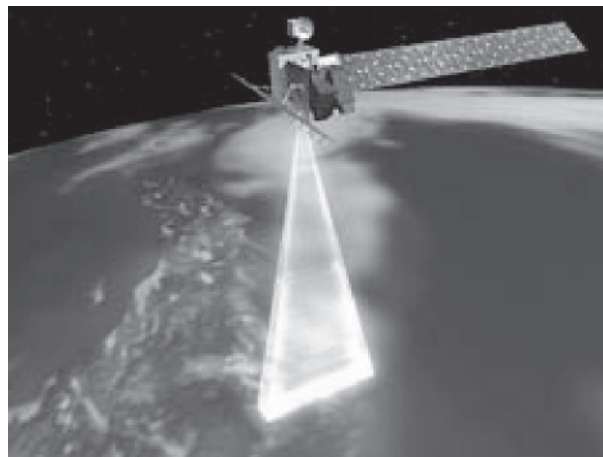

Figure 3-10. ALOS with AVNIR-2 visible and near infrared radiometer (from JAXA Web site).

## Galileo

Galileo is a satellite radio navigation system initiative by the European Union and the European Space Agency. Galileo will consist of a constellation of 30 satellites and ground stations providing position information to users in many sectors (transportation, social services, justice system, custom services, public works, search and rescue, etc.). Two experimental spacecraft, GSTB-V2/A and GSTB-V2/B, will be launched in 2005 as part of the Galileo System Test Bed V2. The objectives of this mission are to (1) secure the Galileo frequency allocations by providing a signal in space, (2) develop procedures for on-board clock characterization, (3) better understand the radiation environment, and (4) conduct related experiments. Launch of the two experimental spacecraft is currently scheduled for late 2005. The first satellites in the full array are scheduled for launch in late 2007.

These satellites will be equipped with LLR arrays to provide precise orbit determination. The two experimental satellites will have two different arrays; the array for GSTB-V2/A is being built by Surrey Satellite Technology Ltd in the UK and the array for GSTB-V2/B by Galileo Industries. Both are flat arrays with coated cubes; anticipated signal link is comparable to that of the GPS satellites.

For more information on the Galileo mission, refer to <http://www.esa.int/export/esaNA/galileo.html>.

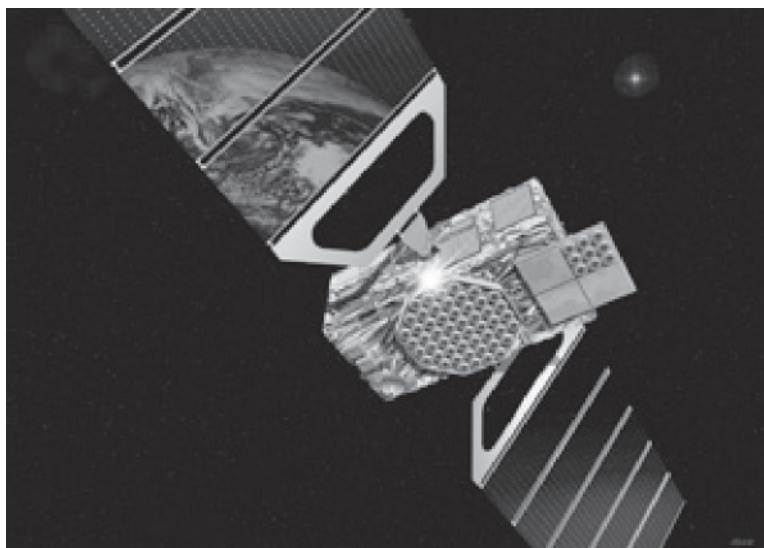

Figure 3-11. Galileo satellite (from ESA Web site).

### ***Optical Inter-orbit Communications Engineering Test Satellite (OICETS)***

The JAXA Optical Inter-orbit Communications Engineering Satellite (OICETS) is a demonstration of the optical communications with the ESA geostationary Advanced Relay and Technology MISSION (ARTEMIS). The experiment will verify important technology for large volume optical communications between satellites, a crucial capability for future space activities, including global-scale data acquisition from Earth observation satellites and stable communications for manned space missions. Optical communications provides wider bandwidth than radio frequencies and lighter on-board equipment. The experiment will include acquisition, tracking, and pointing technologies with ARTEMIS, and study the effects of micro-vibrations of the satellites on the communications link. SLR will provide the primary POD for OICETS.

For more information on OICETS, refer to <http://god.tksc.jaxa.jp/oi/oicets.html>.

### ***Atmospheric Neutral Density Experiment (ANDE) Risk Reduction Mission***

The Atmospheric Neutral Density Experiment (ANDE) Risk Reduction Mission consists of two spherical spacecraft fitted with retro-reflectors for satellite laser ranging (SLR). Two ANDE missions, each with two satellites, will be launched from the Space Shuttle in 2006 and 2008 respectively. The main mission objective of the first mission (ANDE RRM) is to test the deployment mechanism from the shuttle for the ANDE flight in 2008 and to begin preliminary scientific measurements. Scientific objectives of the ANDE missions include monitoring total neutral density along the orbit for improved orbit determination of space objects, monitoring the spin rate and orientation of the spacecraft to better understand in-orbit dynamics, and to provide a test object for polarimetry studies. The mission will provide objects in low Earth orbit with well-determined ballistic coefficients and radar cross-sections for comprehensive atmospheric modeling. Each mission will include a passive and an active spherical spacecraft in a lead-trail orbit configuration. The passive sphere will be tracked with the Space Surveillance Network (SSN) and SLR to study atmospheric drag and in-track total density. The active sphere will have on-board instrumentation to measure atmospheric density and composition. The active sphere will monitor its position relative to the passive sphere to study drag models. The active satellites will communicate on-board data through a system of modulated retro-reflectors (MRR).

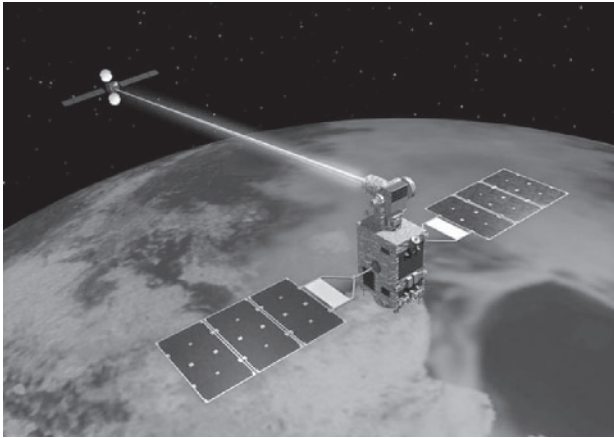

Figure 3-12. OICETS satellite (from JAXA Web site).

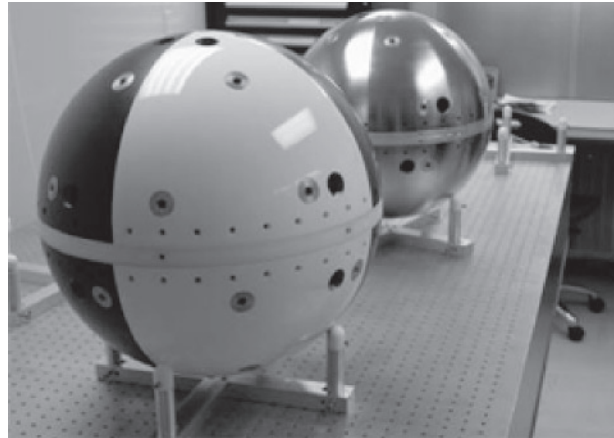

Figure 3-13. Active and passive spheres of the ANDE mission (from NRL).

### **Gravity Field and Steady-State Ocean Circulation Explorer (GOCE)**

GOCE is dedicated to measuring the Earth's gravity field and modeling the geoid with extremely high accuracy and spatial resolution. It is the first Earth Explorer Core mission to be developed as part of the ESA Living Planet Program and is scheduled for launch in 2006.

The geoid, which is defined by the Earth's gravity field, is a surface of equal gravitational potential. It follows a hypothetical ocean surface at rest (in the absence of tides and currents). A precise model of the Earth's geoid is crucial for deriving accurate measurements of ocean circulation, sea-level change and terrestrial ice dynamics – all of which are affected by climate change. The geoid is also used as a reference surface from which to map all topographical features on the planet. An improved knowledge of gravity anomalies will contribute to a better understanding of the Earth's interior, such as the physics and dynamics associated with volcanism and earthquakes and also further our knowledge of land uplift due to post-glacial rebound.

The mission objectives are to determine the gravity-field anomalies with an accuracy of 1 mGal (where 1 mGal =  $10^{-5}$  m/s<sup>2</sup>), determine the geoid with an accuracy of 1-2 cm, all with a spatial resolution better than 100 km.

The GOCE spacecraft is a rigid octagonal shape of approximately 5 m long and 1 m in diameter with fixed solar wings with no moving parts. The payload will include a gravity gradiometer with three pairs of 3-axis, servo-controlled, capacitive accelerometers (each pair separated by a distance of 0.5 m), a 12-channel GPS receiver with geodetic quality, and laser retroreflector for ground-based ranging.

For more information on GOCE, refer to: [http://www.esa.int/export/esaLP/ESAYEKIVMOC\\_goce\\_0.html](http://www.esa.int/export/esaLP/ESAYEKIVMOC_goce_0.html).



Figure 3-14. GOCE satellite (from ESA Web site).

---

# SECTION 4

## INFRASTRUCTURE



FRASER PRINCIPALS





# SECTION 4

---

## INFRASTRUCTURE

*Carey Noll/GSFC*

### Web Site Developments

Enhancements to the ILRS Web site continued in 2003 and 2004. A completely re-designed station section was implemented in early 2003. A clickable map leads the user to individual station pages that are updated daily from the site logs and pertinent SLRMail messages. Also available are station-specific meteorological data charts (temperature, humidity, and pressure) and system performance charts detailing data quantity (number of normal points, observations per normal point, full-rate observations per segment) and quality information (RMS, system delay). Due to NASA budget constraints, however, these meteorological and performance data charts have not been updated since late 2003 but are in the process of being updated. The station's site log is also parsed and presented in a section-by-section format for ease of use. The main station pages on the ILRS Web site are available at: <http://ilrs.gsfc.nasa.gov/stations/index.html>.

Even though not part of the main ILRS Web site, a Web site containing the proceedings from the 14<sup>th</sup> International Workshop on Laser Ranging was developed and implemented in 2004. This site (<http://cdis.gsfc.nasa.gov/lw14/>) includes links to presentations, posters, and papers from the workshop. A new Web site devoted to SLR2000 was also deployed in early 2004. The site, <http://cdis.gsfc.nasa.gov/slr2000>, provides the latest news about the system as well as links to system component information, relevant presentations, and recent photos.

### ILRS Reporting

The Central Bureau continued to provide quarterly performance report cards in 2003 and 2004. This report provides metrics with accompanying charts on ILRS network data quantity, data quality, and operational compliance. These results include independent assessments of station performance from several of the ILRS analysis/associate analysis centers.

Sites were constantly reminded to review and update their Site and System Information Forms. These forms, commonly referred to as site logs, contain detailed site information (e.g., coordinates, contact information, collocation information, site identifiers, local survey ties, and system eccentricities), ranging machine sub-system configuration specifications (e.g., laser, telescope/mount, receiver, timing, meteorological devices, and data processing systems) along with system ranging capabilities. Stations were also asked to complete a survey of prediction usage. This information is utilized by the Central Bureau to determine which data sets are used by the network and whether the predictions are sufficiently accurate for ranging operations.

The 2002 ILRS Annual Report was issued and can be viewed on the ILRS Web site. ILRS analysis center reports and inputs are used by the Central Bureau for weekly review of station performance and to provide feedback to the stations when necessary. These reports as well as special weekly reports on on-going campaigns are issued by e-mail. A catalogue of diagnostic methods, for use along the entire data chain starting with data collection at the stations, has emerged from this process and will be made available on the ILRS Web site. The evaluation process has been helpful in comparing results from different analysis and associate analysis centers, a role soon to be assumed by the Analysis Working Group.

## Data Center Developments

### *Data integrity checks*

Both HTSI and the EDC, as part of their operational data center responsibilities, provide data integrity checks on all incoming SLR normal point data. The software tests for valid values for seconds, surface pressure, temperature, and humidity, checks for modifications to the release flag, and validates the number of digits in the data record and the checksum as specified on the ILRS Web site at

[http://ilrs.gsfc.nasa.gov/products\\_formats\\_procedures/normal\\_point/format\\_and\\_data\\_integrity.html](http://ilrs.gsfc.nasa.gov/products_formats_procedures/normal_point/format_and_data_integrity.html).

### *Archive structure*

A new server for the CDDIS was procured in 2003 and will be operational by January 2005. A modified archive structure for laser data (as well as other data sets archived by the CDDIS) will be implemented on this new server [cddis.gsfc.nasa.gov](http://cddis.gsfc.nasa.gov). The proposed structure for the CDDIS laser data archive provides a more logical and user-friendly format for both directories and filenames. This structure and naming convention also provides uniformity between the normal point and full-rate data types. Furthermore, the layout of the laser data archive will be more consistent with other types of space geodesy data available through the CDDIS.

The changes to the CDDIS laser data archive are in the structure of the directories and the names of the files. The contents of the files will not change: daily normal point files contain data received in the previous 24-hour period, hourly normal point files contain data received in the previous one-hour period, and monthly normal point and full-rate files contain data dated for the month reflected in the file name. The formats of normal point and full-rate data also remain unchanged.

EDC will review the structure and determine if any change at their archive is feasible.



---

# SECTION 5

## TRACKING PROCEDURES AND DATA FLOW



ERSON TRAINING





# SECTION 5

---

## TRACKING PROCEDURES AND DATA FLOW

### **Tracking Priorities**

*Carey Noll/GSFC*

The ILRS tries to order its tracking priorities (shown in Table 5-1) to maximize the utility to the users of ILRS data. Nominally tracking priorities decrease with increasing orbital altitude and increasing orbital inclination (at a given altitude). Priorities for some satellites are then increased to intensify support for active missions (such as altimetry), special campaigns (such as IGLOS), and post-launch intensive tracking campaigns. Some slight reordering may then be given missions with increased importance to the analysis community. Some tandem missions (e.g., GRACE-A and -B) may be tracked on alternate passes at the request of the sponsor. Stations may also adjust priorities to accommodate local conditions such as system capabilities, weather, and special program interests.

Tracking priorities are formally reviewed semi-annually by the ILRS Governing Board. Updates are made as necessary. The Central Bureau communicates these updates to the ILRS stations.

**Table 5-1. Satellite and Lunar Tracking Priorities****Satellite Priorities**

Priority	Satellite	Sponsor	Altitude (km)		Comments
1	GP-B	NASA, Stanford U.	642	90	
2	ICESat	NASA, U. Texas	600	94	Ranging limited to approved stations
3	GRACE-A/B	GFZ, JPL	485-500	89	Tandem mission
4	CHAMP	GFZ	429-474	87.3	
5	GFO-1	U.S. Navy	790	108.0	No other tracking technique
6	Envisat	ESA	796	98.6	Tandem mission with ERS-2
7	ERS-2	ESA	800	98.6	Tandem mission with Envisat
8	Jason	NASA, CNES	1,350	66.0	Tandem mission with TOPEX
9	TOPEX/Poseidon	NASA, CNES	1,350	66.0	Tandem mission with Jason
10	Larets	IPIE	691	98.2	
11	Starlette	CNES	815-1,100	49.8	
12	Stella	CNES	815	98.6	
13	Meteor-3M	IPIE	1,000	99.6	No other tracking technique
14	Ajisai	JAXA	1,485	50	
15	LAGEOS-2	ASI, NASA	5,625	52.6	
16	LAGEOS-1	NASA	5,850	109.8	
17	BE-C	NASA	950-1,300	41	
18	Etalon-1	Russian Federation	19,100	65.3	
19	Etalon-2	Russian Federation	19,100	65.2	
20	GLONASS-89	Russian Federation	19,400	65	Replaced GLONASS-86 (20-Mar-2003)
21	GLONASS-87	Russian Federation	19,400	65	Replaced GLONASS-88 (20-Feb-2002)
22	GLONASS-84	Russian Federation	19,400	65	Replaced GLONASS-79 (22-Feb-2001)
23	GPS-35	U.S. DoD	20,100	54.2	
24	GPS-36	U.S. DoD	20,100	55.0	

**Lunar Priorities**

Priority	Retroreflector Array	Sponsor	Altitude (km)
1	Apollo 15	NASA	356,400
2	Apollo 11	NASA	356,400
3	Apollo 14	NASA	356,400
4	Luna 21	Russian Federation	356,400
5	Luna 17	Russian Federation	356,400

**Restricted Tracking on Satellites with Vulnerable Payloads**

*Michael Pearlman/CfA, Werner Gurtner/AIUB, Peter Shelus/CSR*

Several satellites currently in orbit or planned for launch have detectors aboard that could be destroyed by laser radiation from the SLR ground systems. Careful procedures are being implemented for the safety of these satellites, and as a result, only a few stations (McDonald, Zimmerwald, and Graz) are participating in these tracking activities to date. It is anticipated that additional stations will qualify once they demonstrate that they can abide by the procedures.

## ***ICESat***

ICESat, launched January 12, 2003, is normally nadir pointing, with occasionally off-nadir excursions in a range 3 to 7 degrees. A 70-degree maximum elevation pointing restriction has been implemented at the participating ground stations precluding illumination during nadir pointing and the 3-7 degrees off nadir excursions. There is still concern, however, that off-nadir operations beyond 7 degrees, although not planned at this time, might place the satellite in a jeopardized situation.

UT/CSR, the prediction provider for ICESat, currently issues daily IRV's by e-mail. Stations are instructed to range only if current day IRV's are issued. In the event that unusual operating conditions or emergencies place the satellite in jeopardy, CSR will not issue predictions. Once stations have demonstrated proper implementation of the tracking procedures on test satellites, authorization to track ICESat may be granted to the station through a bi-lateral informal agreement with the ICESat Mission.

## ***ALOS***

The situation with ALOS, scheduled for launch in late 2005, will be more complicated. ALOS has sensors that sweep side-to-side, normal to the satellite ground track, and sensors in the front and back of the satellite. Tracking segments and blockages will have to be scheduled during normal over-flight to avoid vulnerable periods that may occur several times during a pass. The ALOS project will issue IRV's and tracking schedules to stations and identify the allowable tracking segments. Procedures at the stations must automatically recognize and de-activate the SLR system outside the allowable tracking periods.

The ALOS is now considering options for its agreement with the tracking stations.

## ***Plan for Tracking Vulnerable Satellites***

In support of these missions, stations will be issued hard pointing constraints (e.g., do not exceed 70 degrees elevation) and strict pass segment schedules to restrict tracking to non-vulnerable periods. These pass segment schedules must automatically control the laser operation if a station is to participate.

The ILRS is also in the process of implementing a hard "Go-No Go" global key, which is set by the mission and made available to the stations by ftp and the web. The stations must access the key prior to the pass in order to range. Without the "Go" key, ranging must be automatically precluded.

Stations must document their procedures to implement the tracking restrictions and demonstrate their procedures through prescribed tests prior to authorization. Additional rules may apply at the behest of the particular mission.

## **Data Flow**

### ***Carey Noll/GSFC***

The ILRS continues to improve data throughput. Data from the field stations are now submitted hourly and made available immediately through the data centers for rapid access by the user community and prediction providers. With this faster submission of data, better quality predictions are available more frequently and prediction quality assessment is available in near real-time. The tracking of very low Earth orbit satellites continues to improve through the sub-daily issue of predictions, drag functions, and the real-time exchange of time bias information through AIUB.

## Predictions

Carey Noll/GSFC

### Current Status

There are now eight centers that provide SLR predictions on a regular basis (see Table 5-2). Quality assessments of the all of the predictions are available 24 hours a day/7 days a week on the AIUB near-real-time Time Bias Server at [http://aiuas3.unibe.ch/cgi-bin/cgi-time\\_bias](http://aiuas3.unibe.ch/cgi-bin/cgi-time_bias). The NERC Space Geodesy Facility (NSGF) group automatically collects normal point data on an hourly basis to compute updated time bias functions (with respect to available IRV sets) for all ILRS satellites. These time biases are distributed by an automated program that accesses the latest time bias functions at NSGF and computes time biases for the current epoch (including drag functions, if existing) for all available satellites and IRV sets. For all current predictions, stations can get the best current estimates of time bias for all satellites. Procedures for the usage of this real-time time bias information are available at the ILRS Web site.

The ILRS is now developing a consolidated laser ranging prediction format (see below) that can be used for ranging to near Earth satellites and the moon, and for transponder ranging to planets and interplanetary spacecraft. Also included are options for standardizing prediction interpolators used at the stations (see Prediction Format Study Group activities below).

Periodically the ILRS Central Bureau surveys the SLR stations to find out which prediction data sets are being used and whether these predictions are sufficiently accurate for ranging operations. This survey information allows the ILRS to assess how well the service is satisfying the requirements of the stations and where additional effort should be placed. In July 2004, the stations were asked which prediction provider they are using. If they use the GFZ drag function for low satellites, what problems have been encountered in satellite acquisition, and how the predictions are retrieved (e-mail or ftp). Comments and suggestions were also solicited. Nearly all stations in the ILRS network responded to the survey and the results were posted on the Web site ([http://ilrs.gsfc.nasa.gov/products\\_formats\\_procedures/predictions/prediction\\_survey/index.html](http://ilrs.gsfc.nasa.gov/products_formats_procedures/predictions/prediction_survey/index.html)).

**Table 5-2. Satellite Prediction Providers**

Center	Interval	Satellites
CSR	Daily	ICESat
ESOC	Daily	Envisat
GFZ	Sub-daily	ERS-2, GRACE-A/B, CHAMP
GSFC	Daily/Sub-weekly	GFO-1/Meteor-3M
HTSI	Daily	All
JAXA	Weekly	Ajisai, LAGEOS-1/2
MCC	Sub-weekly	LARETS
NERC/CODE	Daily, Sub-daily	GPS, GLONASS

The ILRS is encouraging stations to use the mission provided or sanctioned predictions for these satellites where they are available. Some of the recent missions have periodic maneuvers or drag compensation capability, and some also have GPS data to enhance the SLR predictions. Since the missions have the most up-to-date information of this type, they are in the best position to keep predictions current.

## **Prediction Format Study Group Activities**

*Randall Ricklefs/CSR*

During the last two years, the Prediction Format Study Group has been actively developing, reviewing, and testing versions of the Consolidated Prediction Format (CPF). During 2003, a trial version was posted on the ILRS Web site and the entire laser ranging community including SLR and LLR analysts was invited to comment. From the resulting input and other developments, several revisions have been prepared, culminating in the latest, and hopefully final, version being posted on the ILRS Web site in September of 2004.

Also during this time tests of the CPF have been conducted using the sample implementation code to show that the original accuracy of the SLR, LLR, and transponder predictions can be recovered. In addition, the first phase of field tests at the McDonald Laser Ranging System (MLRS) were conducted using the CPF to track several satellite passes in the spring of 2004. The tests are aimed at insuring that nothing has been omitted from the format and that the information included can be used effectively. The work of improving the sample code and fully implementing it at MLRS is proceeding. We expect to broaden the tests to more stations with predictions being provided by several groups such as NERC Space Geodesy Facility (NSGF) for SLR and MLRS for LLR. With these additional steps, will start to develop the infrastructure to implement the format.





---

# SECTION 6

## EMERGING TECHNOLOGIES



EMERGING TECHNOLOGIES



EMERGING TECHNOLOGIES





# SECTION 6

---

## EMERGING TECHNOLOGIES

*John Degnan/Sigma Space Corporation*

### Introduction

This report is largely, but not exclusively, based on the technical papers presented at the 14th International Workshop on Laser Ranging, held in San Fernando, Spain in June 2004. The report also draws on material from the ILRS Workshops held in Koetzting (Germany) and Graz (Austria) in October 2003 and 2004 respectively. It is not intended as a review of all that was presented, since the online abstracts and papers do that adequately. Instead, it is a subjective attempt to summarize and comment on the key technology trends and highlights (hardware only) and to tie key engineering papers into an overall perspective. The engineering of SLR components is advancing rapidly on all fronts and are largely directed toward three principal goals: (1) 1 mm absolute ranging accuracy; (2) remote, autonomous, and/or eyesafe operations; and (3) kilohertz photon-counting systems.

### Kilohertz Photon-Counting Systems

Some of the motivations for developing photon-counting, low energy, high repetition rate systems include:

1. The possibility of eye-safe operations makes remote or autonomous unmanned operations more likely;
2. Diode-pumped low energy lasers are simpler, less prone to optical damage, longer-lived and require less maintenance;
3. Range estimates based on photon-counting are totally unbiased and over many measurements accurately reproduce the impulse response of the target array thereby driving down the instrument systematic error;
4. Many low energy range measurements at a high repetition rate substantially reduce normal point random error relative to a high energy, low rate system of equal power;
5. The possibility of generating unbiased estimates of the measured time of flight at two colors combined with a several order of magnitude increase in the range returns per normal point may overcome some of the current obstacles to correcting for the atmosphere via multicolor ranging ;
6. The replication and operational costs are expected to be significantly lower relative to the larger manned systems; and
7. Such photon-counting systems pave the way for two-way interplanetary ranging with modest telescope apertures and laser powers and can simultaneously serve as ranging beacons in future space-to-ground optical communications links.

The SLR2000 concept, on which the future NASA SLR network is largely based, is a major departure from past SLR system designs. In an attempt to make the system eyesafe, transmitted laser pulse energies have been reduced by over three orders of magnitude relative to current manned NASA systems, i.e., from 100 mJ in a MOBLAS to about 65  $\mu$ J in SLR2000. To compensate for the reduced photon signal flux into the receiver, the laser fire rate has been drastically increased from 5 Hz to 2000 Hz, high SNR multi-photon receivers have been replaced by low SNR photon-counting receivers, and beam divergences have been reduced from roughly 30 arcsec in a MOBLAS to about 10 arcsec (variable) in SLR2000.

The eyesafe requirement places tight constraints on the system configuration and design. Attenuation in the atmosphere and the optical materials used in satellite retroreflector arrays (typically fused silica or BK-7 glass) limits the choice of

operating wavelength to between 400 and 2500 microns. Although there are “eyesafe” laser sources in the near infrared beyond 1400 nm (e.g., the 1550 nm Er:YAG microchip laser), there are currently no suitable picosecond devices for precise ranging. Furthermore, commercial high-speed photon counting detector quantum efficiencies (QE) are typically two orders of magnitude worse (<0.4%) than at 532 nm. Thus, even if suitable lasers were available at 1550 nm, the transmitter energy/power would have to be increased by a factor of 200 to achieve the same photon return rate as the current prototype. A good summary of the laboratory state-of-the-art in eyesafe, photon-counting detectors at 1550 nm was provided at the San Fernando Workshop (Prochazka and Hamal, 2004a). These advanced detectors have efficiencies on the order of 10% but must be cooled to very low temperatures to achieve low dark count rates.

For non-eyesafe wavelengths below 1400 nm, one must either reduce the laser flux at the telescope exit aperture below the ANSI Maximum Permissible Exposure (MPE) standards or employ additional sensors (e.g., motion detectors, aircraft surveillance radars, etc.) to reliably detect personnel and/or aircraft intrusions into the laser beam path before they occur and shut down laser operations. While either approach is viable, reducing the laser flux to meet ANSI standards was viewed as a relatively fail-safe approach by the SLR2000 team. Unfortunately, the MPE standards were recently revised downward in 2000 after SLR2000 development was well underway, and the change resulted in a factor of two reduction in the transmittable energy (from 130  $\mu$ J to 65  $\mu$ J) for the current 40 cm telescope aperture and 300 psec laser pulse width. Fortunately, this loss in signal strength can be more than compensated for by recently developed high quantum efficiency photomultipliers from Hamamatsu, which incorporate GaAsP photocathodes (QE = 40% compared to 13% in the Photek tubes).

Near-infrared wavelengths below the eyesafe limit at 1400 nm, such as Nd:YAG at 1064 nm, are not focused on the retina, but they can cause corneal damage at sufficient intensities. Furthermore, since the observer is unaware that he/she is being illuminated (i.e., there is no “blink effect” as with visible lasers), OSHA requires that infrared pulses be integrated over a 10 second period rather than 0.25 seconds for visible wavelengths. As a result, even though the single pulse MPE is 10 times higher at 1064 nm than at 532 nm, the longer integration time in the infrared reduces the ten-fold single pulse MPE advantage at 1064 nm to only a factor of 4 at a nominal 2 kHz laser fire rate. It can be shown, using the link equation, that an eyesafe 1064 system would under-perform an eyesafe 532 nm system at satellite zenith angles below 50 degrees and slightly over-perform above 50 degrees. The transition at 50 degrees is due to the higher atmospheric transmission at 1064 nm. Overall, the projected performance at 1064 nm is worse than at 532 nm due to an order of magnitude (or greater) reduction in detector quantum efficiency and a factor of 4 signal reduction in target optical cross-section. Smaller advantages of 1064 nm over 532 nm – such as no frequency converter (x2), lower photon energy (x2), and higher one-way atmospheric transmission (92% vs. 70% in a Standard Clear Atmosphere) cannot compensate except at very low elevation angles. The latter assessment assumes a best case QE of 4% at 1064 nm whereas most commercial photon-counting detectors with near zero dead-times have QE’s of 1% or lower. It should also be mentioned, however, that Intevac Inc. is projecting a QE of 30% at 1064 nm for its new hybrid PMT/APD device.

In short, transmitter pulse energy/power would have to be increased by a minimum factor of 15 at 1064 nm (exceeding eyesafe limits) and a factor of 200 at 1550 nm to produce the same measurement rate at the higher satellite zenith angles as an upgraded SLR2000 system with a high QE GaAsP photocathode. Since this puts a much larger burden on the transmitter at the longer wavelengths, it appears that 532 nm is the proper choice of wavelength for the upgraded NASA SLR network, and it is currently the wavelength of choice at 95% of the existing SLR stations within the ILRS global network. This situation could change, however, if and when better NIR detectors become available.

Recent field successes of the as yet uncompleted SLR2000 prototype (McGarry et al, 2004) and the recently upgraded Graz SLR station (Kirchner and Koidl, 2004) in tracking satellites lend great credence to the viability and soundness of the high repetition rate, photon-counting approach, and clearly many technical hurdles have already been overcome. The Graz system collects phenomenal amounts of data even at GPS altitudes of 20,000 km, and they have recorded over 1 million range measurements in a single LAGEOS pass, in agreement with theoretical predictions. It is therefore worthwhile to compare the link characteristics of SLR2000 and Graz. This is done in Table 6-1 where we note that,

all other factors being approximately equal (e.g., beam divergence, optical throughput efficiency, etc.), one can define a system Figure of Merit equal to the product of the detector QE, laser energy, and telescope aperture. By this criteria alone, Graz presently has an 8 to 1 signal advantage over SLR2000 due primarily to a higher power transmitter (not eyesafe), slightly larger telescope receive aperture, and higher QE detector. As shown in Table 6-1, this advantage can be reduced to 2.6 to 1 by simply replacing the current Bi-alkali Photek quadrant detector in SLR2000 with a GaAsP photomultiplier from Hamamatsu. Increasing the current SLR2000 40 cm telescope aperture to 50 cm would nullify any residual advantage by permitting the eyesafe output energy to be increased to about 100  $\mu$ J at the exit aperture while simultaneously increasing the receive aperture by 50%. Thus, there appears to be no reason that an upgraded SLR2000 could not achieve the same overall range measurement rates as the Graz station without sacrificing eye safety. Advantages of the proposed detector upgrade relative to the Compensated Single Photoelectron Avalanche Detector (C-SPAD) used in the Graz system are: (1) a factor of 2 higher QE; and (2) a negligible dead time in the GaAsP microchannel plate photomultiplier as compared to the single stop per fire characteristics of the C-SPAD.

**Table 6-1: Comparison of SLR2000 plus potential upgrades with new Graz 2 kHz station**

System	SLR2000	Graz 2 kHz System
Laser Energy (at source)	120 mJ	400 mJ
Laser Fire Rate	2 kHz	2 kHz
Laser Pulsewidth	300 psec	25 psec
Laser Wavelength	532 nm	532 nm
Telescope Receive Area	0.126 m <sup>2</sup> (40 cm diameter)	0.196 m <sup>2</sup> (50 cm diameter)
Detector Quantum Efficiency	0.13 (Bi-Alkali MCP/PMT) 0.4 (GaAsP MCP/PMT)	0.2 (C-SPAD)
QE-Energy-Aperture Product (Figure of Merit)	1.95 mJ-m <sup>2</sup> (SLR2000 Prototype) 6.00 mJ-m <sup>2</sup> (GaAsP) 14.6 mJ-m <sup>2</sup> (GaAsP + 50 cm tel.)	15.7 mJ-m <sup>2</sup>
Signal Strength Advantage (Normalized to SLR2000 prototype)	1 (SLR2000 prototype) 3.07 (GaAsP upgrade) 7.5 (GaAsP + 50 cm telescope)	8 (rel to SLR2000 prototype) 2.62 (rel to GaAsP upgrade) 1.06 (rel to GaAsP+50 cm upgrade)
Transmitter Fills Telescope?	Yes, Monostatic	No, Bistatic
Meets ANSI Eye Safety Standards?	Yes	No
Telescope/Tracking Mount	Developmental	Established System
Operator-assisted	Yes – during test phase No - operationally	Yes
Maximum Satellite Altitude Targeted	20,000 km (GPS)	20,000 (GPS/GLONASS)
Maximum Satellite Altitude Demonstrated to Date	1500 km (TOPEX/Poseidon)	20,000 km (GPS/GLONASS)

Because of the extremely short 25 psec pulse width available from the High-Q SESAM oscillator, Graz has also demonstrated the ability to resolve single reflectors within the target array (Kirchner and Koidl, 2004). The ultimate scientific usefulness of this capability is unclear, however, especially when one considers the considerable pulse spreading caused by the satellite arrays. Furthermore, the roughly order of magnitude reduction in transmittable energy that would be imposed by the latest ANSI guidelines for such short pulses would severely degrade the link margin for eyesafe operation and result in greatly reduced signal return rates. Thus, given the eyesafe requirement imposed on SLR2000, NASA presently plans to retain the 200 to 300 psec pulse widths as currently implemented in the SLR2000 prototype.

## Detectors

With the growing emphasis on photon-counting and high repetition rate systems, the quantum efficiency (QE) and dead time of the detector following detection of a “photon event” become increasingly important. The range return rate varies linearly with QE, and a long dead time implies narrower range gates for daylight operation against a solar background. At 532 nm, conventional bi-alkali or multi-alkali cathodes typically have QE’s in the 10 to 18% range. Actual counting efficiencies are often reduced to 60% or 70% of these numbers due to internal tube losses (e.g., the “dead space” between microchannels).

Burle Industries in the US offers gated GaAs photomultipliers with 30% QE. Hamamatsu Corporation is now offering micro-channel plate photomultipliers with 40% QE GaAsP photocathodes and overall counting efficiencies of 26% at 532 nm, but they are significantly more expensive than the older bi-alkali tubes. The Hamamatsu tubes are also available in multi-anode configurations for quadrant or 3D lidar imaging applications.

Hamamatsu has also recently introduced new photon counting InGaAsP detectors covering the infrared out to 1700 nm (i.e., well into the eyesafe regime beyond 1400 m), but they must be cooled and counting efficiencies are typically less than 1%. However, MIT Lincoln Laboratory in the US has recently been touting photon-counting InGaAsP arrays with QE’s greater than 50% at 1064 nm. These are presently limited to a single-stop per pixel element and, to the author’s knowledge, are not yet available commercially. In San Fernando, Prochaska and Karel Hamal of the Czech Technical University reported QE’s of 10%, 200 psec timing resolutions, sensitivities out to 1.8  $\mu$ , and operating temperatures between 150 and 210K for their InGaAs APD’s. Unfortunately, the fastest picosecond timing devices were characterized by very high dark count rates (~10 MHz), and device availability is presently very limited.

## Multi-Wavelength Ranging

The need and accuracy requirements for multiwavelength ranging are driven by the quality of the atmospheric models used to correct for the atmospheric delay in single wavelength systems. The ultimate performance of any model depends on inputs to the model, e.g., the accuracy of the in situ measurements of pressure, temperature, and relative humidity. For example, temperature and relative humidity measurement accuracies produce sub-mm range errors in the Marini-Murray (M-M) model but a 0.1 mbar pressure error (best case) can produce about 0.8 mm of range error at zenith and 2.4 mm of range error at 20° elevation. However, even if the model inputs had zero error, one must ask the question: How well does the model represent the physical atmosphere?

The effect of deviations of the vertical structure from hydrostatic equilibrium on M-M have been estimated to be less than 1 cm at elevations above 20° elevation (Hauser, 1989) as are the effects of horizontal gradients (Abshire and Gardner, 1985). The M-M model is static (time-independent) whereas random fluctuations in delay due to turbulence effects are typically a few mm but can be a few cm at 10° elevation under conditions of strong turbulence (Abshire and Gardner, 1985). Although some competing atmospheric models are believed to be better than M-M at wavelengths below 500 nm due to better physics and at low elevation angles due to better mathematical approximations, they are all unable to take into account the aforementioned effects. With potential unmodeled errors at the cm level, the only way to unequivocally achieve mm-accuracy range measurements is through direct measurement of the atmospheric delay via multi-wavelength ranging. It should be mentioned, however, that at least one group (Hulley et al, 2004) reported in San Fernando that it is attempting to improve real-time atmospheric models by making use of data from Earth remote sensing satellites.

Theoretical trade studies have suggested that the optimum wavelength pairs for two-color ranging are the 2nd and 3rd harmonics of Nd:YAG at 532 and 355 nm respectively or the 1st and 2nd harmonics of the tunable Ti:Sapphire laser, nominally at 800 and 400 nm. This “Figure of Merit” analysis (Degnan, 1993) takes into account the wavelength dependence of the dispersion and transmission of the atmosphere, detector quantum efficiencies, nonlinear conversion efficiencies, and the beam divergence from fixed transmit and reflector apertures. In order to achieve 1 mm absolute

accuracy in the atmospheric correction or even to validate existing models at the mm level, the Differential Time-Of-Flight (DTOF) between pulses at 532 and 355 nm must be measured with an absolute accuracy of less than 0.6 psec. Although alternative wavelength pairs that do not take advantage of the high atmospheric dispersion in the UV have even more stringent differential timing requirements (<0.4 psec at 846 and 423 nm), they often have other offsetting advantages such as better transmission through the atmosphere.

Various groups have performed multi-wavelength ranging experiments to satellites via the following approaches:

- Low repetition rate, high SNR systems using Photo-Multiplier Tubes (PMT's) or Single Photoelectron Avalanche Detection (SPAD's) – GSFC, Wettzell/TIGO, Graz, Zimmerwald, EOS Australia, Grasse
- Low repetition rate, high SNR systems augmented by streak cameras – GSFC, Wettzell/TIGO, Matera
- Low repetition rate, waveform averaging of streak camera profiles – Wettzell
- Three or more wavelengths – Graz in collaboration with Czech Technical University, CNES, etc

Unfortunately, none of these experiments has yet resulted in DTOF measurements of sufficient accuracy to support mm satellite ranging. In fact, DTOF measurements based on single pulse pairs are rendered useless by phase and polarization mixing of the multicube returns from most of the existing satellite arrays, independent of the type or temporal resolution of the range receiver (PMT, SPAD, Streak Camera, etc.). This intercube mixing results in large shot-to-shot variations in the return waveforms at a single wavelength, and, as demonstrated by a series of two color streak camera waveforms taken at GSFC for various satellites from 1996 to 1997, the waveforms at different wavelengths are highly uncorrelated (e.g., different numbers of peaks on a single shot) thereby negating possible pulse pair convolution approaches to determining the DTOF. An exception was the short-lived ADEOS/RIS experiment, which consisted of a single large retro. Although the latter target had a delta function impulse response, it also had a limited cross-section, range, and field of view. The decommissioned WESTPAC satellite produced single cube returns, but the design also resulted in large modulations of the target cross-section with orientation, causing the satellite to “wink out” periodically. New large radius satellites with recessed cubes (e.g., a Super-LAGEOS) would approximate a flat panel array at normal incidence (very narrow impulse response) at all satellite orientations while providing a constant high optical cross-section for long-distance ranging to low-drag geodetic altitudes (Degnan, 1993).

At present, there are only a few LEO satellites with quasi-single cube returns (e.g., ERS-1 and similar LEO designs) that should prove useful in near term two-color experiments designed to either test multi-wavelength hardware configurations, to evaluate competing atmospheric models, or to compute key unknown parameters within a particular model. Stefan Riepl at the 2003 Koetzing workshop provided an example of the latter approach. He computed a differential zenith delay by fitting the two color residuals from an entire satellite pass to an atmospheric model. Here the model is used as a “crutch” to estimate a single defining parameter, the differential zenith delay, while the model provides the dependence on satellite elevation. The parameter estimation benefited statistically from the use of all the data within a pass whereas the low laser fire rate precluded meaningful estimates of the DTOF within a single normal point interval.

Of course, the ultimate goal of multi-wavelength ranging is a “model-free” measurement of the atmospheric delay within each normal point. Such a capability would free us from assumptions regarding the instantaneous vertical and transverse structure of the atmosphere. At the 2000 Matera workshop (Degnan, 2000), the author proposed that differencing normal points produced at two different wavelengths in order to compute the DTOF might be the most promising route in the short term. By averaging over a sufficient number of returns, the temporal phase and polarization modulations produced by the multicube response of the target would be expected to average to zero and produce an impulse response based on an incoherent sum of the individual cube responses averaged over an allowed range of satellite orientations. The problem with conventional low repetition rate SLR stations is that they produce too few individual range measurements per normal point to adequately drive down the uncertainty in the single wavelength normal points. KHz photon-counting systems, on the other hand, offer orders of magnitude higher statistical return rates as well as freedom from amplitude bias. Graz has already demonstrated tens of thousands of range measurements per LAGEOS normal point at a single

color. At the 2004 San Fernando Workshop, the Wettzell group (Riepl et al, 2004) reported on a planned two-color kHz system, the Satellite Observing System-Wettzell (SOS-W), which will operate at the 850 and 425 nm wavelengths. Thus, while we await the future launch of satellites truly designed for mm-accuracy ranging, dual wavelength kHz systems may offer the greatest near-term hope of achieving few mm, if not 1 mm, absolute range accuracies.

## **Remote or Autonomous Operation**

The drive toward remote and totally autonomous operation has not only spurred the development of increasingly sophisticated operational software at a number of stations but also a variety of new sensors and actuators to replace crucial human interactions.

Two stations presented their remote operation capabilities in San Fernando. Werner Gurtner demonstrated the operation of the Swiss Zimmerwald station via both Internet and cellular phone (Gurtner, 2004). The Japanese delegation described routine operation of their new GUTS-SLR station on Tanegashima Island in Japan from the Tsukuba Space Center located 1100 km (Sawabe et al, 2004). The new GUTS-SLR system also incorporates some meteorological sensing, a station monitoring subsystem, aircraft surveillance radar, sun avoidance hardware and software, an operator-assisted video subsystem for star calibrations and tracking, etc.

NASA's SLR2000 is designed to be totally autonomous. As such, it requires some unique real-time control elements that are not generally found in conventional, high powered, manned or even remotely operated systems. A "Smart Meteorological Station" measures all-sky cloud cover, ground visibility, precipitation, and wind speed/direction in addition to the usual temperature, pressure, and relative humidity needed for atmospheric calibrations. It also includes autonomous mechanisms and associated software for: (1) maintaining telescope focus over wide ambient temperature excursions; (2) conducting automated star calibrations and updating mathematical mount models; (3) centering the optical receiver field of view (FOV) on the satellite return based on single photon returns in the quadrant ranging detector; (4) varying transmitter beam divergence and point ahead; and (5) controlling the receiver spectral bandwidths and spatial Field-of-View (FOV). As discussed by the author in San Fernando (Degnan, 2004), all of these real-time functions can be accomplished mathematically by utilizing a ray matrix approach, and most have already been demonstrated and validated in field experiments to satellites. The French also reported on an upgraded multicolor Meteorology and Optics (MeO) station at Grasse (Samain et al, 2004).

## **New Applications and SLR Spin-offs**

The "new" applications discussed in San Fernando fell into three categories: (1) time transfer; (2) laser altimetry; and (3) potential synergies with laser communications.

The French and Chinese delegations described two current time transfer experiments. The Shanghai group described a recent laboratory experiment, which demonstrated that a time comparison between two free-running masers via laser link yielded essentially the same slope as a direct transfer of time between the clocks (Yang et al, 2004). The French T2L2 mission is space based and is designed to transfer time between two widely separated ground SLR stations with 50 psec accuracy (Samain et al, 2004).

Laser altimeters have successfully mapped portions of the Moon (Apollo 11, Clementine), Mars (MOLA/Mars Global Surveyor), and most recently the Earth (GLAS/ICESat). NASA's Messenger Laser Altimeter (MLA) is currently enroute to Mercury. These were all low repetition rate (2 to 40 Hz), high energy, multiphoton systems. At the 2002 Workshop in Washington DC, NASA GSFC (Degnan et al) reported on a successful aircraft experiment which used multi-kHz rate microchip lasers from a high altitude aircraft to generate high resolution 3D profiles of the underlying terrain. The scaling of this technology to orbital altitudes for globally contiguous mapping of planets (e.g., Mars) was subsequently described in a series of papers (Degnan, 2001), (Degnan 2002a), (Degnan, 2002b). In San Fernando, the German (Schreiber et al, 2004) and Czech (Prochazka and Hamal, 2004b) groups described a similar kHz rate, photon-counting planetary mapper



known as Laser Altimeter for Planetary Exploration (LAPE), which is being proposed for the European BepiColombo mission to Mercury. In addition to providing higher spatial and range resolution, these low energy kHz systems place fewer demands on scarce spacecraft resources such as mass and prime power and are expected to be more reliable and long-lived than their high energy, low repetition rate, counterparts.

Finally, NASA GSFC (Degnan et al, 2004) argued that satellite laser ranging and lasercom applications are highly synergistic since most of the ground support capabilities required for an automated ground lasercom station are provided by the baseline SLR2000 design. A space-to-ground 10 Gbps downlink and 10 Mbps uplink lasercom capability can be added to SLR2000 for a differential replication cost of about \$600K at an eyesafe wavelength of 1550 nm using COTS telecom parts. The 1550 nm wavelength is not only eyesafe, but the high atmospheric transmission and low scatter combined with low solar output in this spectral region greatly improves the signal to noise situation for free space laser communications.

Range returns from a passive reflector mounted to the lasercom satellite provide independent verification of satellite acquisition and lock and greatly simplify terminal acquisition for lasercom. An onboard CCD array can view the upcoming ranging beacon through a 532 nm filter for initial acquisition of the ranging beacon, in situ identification of the active ground station by its position on the Earth disk, and initial coarse pointing of the onboard lasercom terminal. Narrow FOV 532 nm quadrant detectors at both terminals can further refine the pointing at the sub-arcsecond level. For longer deep space links, active laser transponders can be substituted for passive reflectors.

A 12-station ground SLR2000C network can provide >99.9% availability for LEO to Earth communications using intersatellite relay links. A denser 25 to 30 site SLR2000C network would support both global “bent pipe” LEO to GEO to Earth communications and deep space coverage with > 99% availability. Preliminary link calculations suggest the feasibility of 10 Gbps near-Earth downlinks (4 channels @ 2.5 Gbps per channel) and a 70 Mbps downlink capacity from the Moon with achievable laser powers of a few watts per channel. The authors suggested that multi-user support might increase the likelihood for funding of a substantial global network that would benefit both geodesy and global scientific space-to-ground communications.

## References

- Abshire, J. and Gardner, “Atmospheric Refraction Corrections in Satellite Laser Ranging”, IEEE Trans. on Geoscience and Remote Sensing, GE-23, pp. 414-425, July, 1985
- Degnan, J.J., “Millimeter Accuracy Satellite Laser Ranging: A Review”, in *Contributions of Space Geodesy to Geodynamics: Technology*, D. E. Smith and D. L. Turcotte (Eds.), AGU Geodynamics Series, Volume 25, pp. 133-162, 1993.
- Degnan, J.J., “An Overview of SLR2000 Engineering Progress and Potential Future Upgrades”, 12th International Workshop on Laser Ranging, Matera, Italy, Nov. 13-17, 2000.
- Degnan, J.J., “Photon Counting Microlaser Rangers, Transponders, and Altimeters”, *Surveys in Geophysics*, Special Issue on Evolving Geodesy, Vol 22, Nos. 5-6, pp. 431-447, 2001.
- Degnan, J.J., “A Conceptual Design for a Spaceborne 3D Imaging Lidar”, *J. e&i Elektrotechnik und Informationstechnik*, Vol.4, pp. 99-106, April, 2002a.
- Degnan, J.J., “Photon-Counting Multikilohertz Microlaser Altimeters for Airborne and Spaceborne Topographic Measurements”, *Journal of Geodynamics (Special Issue on Laser Altimetry)*, pp.503-549, November, 2002b.
- Degnan, J.J., “Ray Matrix Approach for the Real Time Control of SLR2000 Optical Elements”, Proc. 14th International Workshop on Laser Ranging, San Fernando, Spain, June 6-10, 2004.
- Degnan, J., A. Seas, H. Donovan, and T. Zagwodzki 2004 “SLR2000C: An autonomous satellite laser ranging and space-to-ground optical communications facility”, *Ibid*, 2004.

- Hauser, J.P., "Effects of Deviations from Hydrostatic Equilibrium on Atmospheric Corrections to Satellite and Lunar Laser Range Measurements", *J. Geophysical Research*, 94, pp. 10,182-10,186, 1989.
- Hulley, G., E. Pavlis, V. Mendes, and D. Pavlis, "Multiwavelength Refraction Modeling Improvements for SLR Observations", *Proc. 14th International Workshop on Laser Ranging*, San Fernando, Spain, June 6-10, 2004.
- Gurtner, W., "Zimmerwald Remote Control By Internet And Cellular Phone", *Ibid*, 2004.
- Kirchner, G., and F. Koidl, "Graz KHz SLR System: Design, Experiences and Results", *Ibid*, 2004.
- McGarry, J., T. Zagwodzki, J. Degnan, J. Cheek, P. Dunn, A. Mallama, D. Patterson, H. Donovan, and A. Mann "Early Satellite Ranging Results from SLR2000", *Ibid*, 2004.
- Prochazka, I. and K. Hamal, "Recent Achievements in Detectors for Eye Safe Laser Ranging", *Ibid*, 2004a.
- Prochazka, I. and K. Hamal, "Laser Altimeter For Planetary Exploration", *Ibid*. 2004b.
- Riepl, S., W. Schlüter, R. Dassing, K.-H. Haufe, N. Brandl, P. Lauber, and A. Neidhardt, "The SOS-W - A Two Colour KiloHertz SLR System", *Ibid*, 2004.
- Schreiber, U., H. Michaelis, J. Oberst, I. Leike, and T. Spohn, " Technical Concept for a European Laser Altimeter for Planetary Exploration", *Ibid*, 2004.
- Samain, E., G. Aridon, P. Exertier, J.F. Mangin, G.M. Lagarde, J.L. Oneto, J. Paris, F. Pierron, and J.M. Torre, " MeO: The Future of the French Lunar Laser Ranging Station", *Ibid*, 2004.
- Sawabe, M., T. Uchimura, S. Murata, Y. Matsuoka, T. Oldham, and J. Maloney, "Remote Operation of GUTS-SLR", *Ibid*, 2004.
- Fumin, Y., Z. Zhongping, C. Wanzhen, L. Xin, C. Juping, and W. Bin,"Time Transfer by Laser Pulses between Ground Stations", *Ibid*, 2004.

## Event Timer Development

*Yuriy Artyukh, Vladimirs Bepal'ko, Eugene Boole, Alexander Rybakov, Vadim Vedin/  
U. of Latvia*

The Riga team has worked in the area of SLR timing system development and production since the 1970s). The work was undertaken to meet the demands of current and potential users, using the Riga SLR station as the main proving ground for new products.

In 2003, the A031-ET Event Timer was offered to ILRS partner stations to replace the currently popular SR620 Time Interval Counter, to provide improved linearity (better precision) and extended functionality (for event timing) at a reasonable price. The performance has been confirmed through testing in 2003 at the Graz station (many thanks to Georg Kirchner, Ludwig Grunwald and others). To date, four A031-ET units have been built and additional requests are expected.

The A031-ET functional capabilities make it possible to measure not only single shot time intervals but also overlapping time intervals, for high repetition-rate SLR. However there are some limitations on the time gap between adjacent measurement cycles. This is acceptable for SLR at repetition rates up to approximately 100 Hz, above which some data dropouts occur. A new version of the A031-ET tailored to kHz SLR is currently under development. Preliminary test results have demonstrated that rates of continuous (gapless) measurement up to 10 K Event/sec can be supported. Development should be finished in late 2004. Preliminary information about this project was discussed at "kHz SLR Meeting", October 27-29 2004 in Graz, Austria.

At the same time, the design of a new two-channel timing system to support two-color SLR over a range of repetition rates has been initiated.



Figure 6-1. Riga event timer team (Missing: A. Rybakov).



---

# SECTION 7

## ANALYSIS PILOT PROJECTS



FRASER PRINCIPALS





# SECTION 7

---

## ANALYSIS PILOT PROJECTS: MILESTONE REACHED

*Ron Noomen/DUT, Graham Appleby/NSGF, and Peter Shelus/CSR*

### Introduction

The most important aspect of the SLR/LLR observations is their absolute accuracy, which approaches the level of a few mm for modern stations. This makes laser ranging an ideal technique to monitor and study specific elements of system Earth. In the case of LLR, applications include the study of fundamental lunar theory (both orbital and internal composition), as well as gravitational theory and relativity. For SLR, applications include determination of the geocenter and its motion, absolute scale, global plate tectonics and vertical station deformations. This aspect has led to reliance on SLR for the definition of origin (fully) and scale (together with VLBI) for IERS' ITRF2000 model for global station coordinates and velocities. The SLR community also produces other geophysical products including Earth Orientation Parameters (EOPs), time-variations of the long-wavelength components in models of the Earth's gravity field, satellite orbit solutions and others. The ILRS is an official Technique Center in the IERS organization. To fully exploit the unique aspects of the SLR observations, the ILRS Analysis Working Group (AWG) addresses various issues of SLR products, such as quality control, parameter and format definition/use, optimization, and (the development of) an official combination product. To this aim, a number of so-called pilot projects have been initiated and have come to show good results. This report contribution presents an update on the development of these projects. General information on AWG activities, membership and more detailed information on the pilot projects can be found on the relevant Internet pages ([http://ilrs.gsfc.nasa.gov/working\\_groups/awg/index.html](http://ilrs.gsfc.nasa.gov/working_groups/awg/index.html)).

### Activities in 2003 and 2004

An important instrument for contacts and discussions among SLR/LLR analysts is the AWG workshops. In the reporting period, such workshops were organized during April 2003 (Nice, France), October 2003 (Kötzing, Germany), April 2004 (Nice), June 2004 (San Fernando, Spain) and December 2004 (San Francisco, USA). The majority of the meetings took place on dates close to major geophysical meetings (EGU, AGU) in order both to maximize AWG members' attendance and also encourage contact with other scientists. The pilot projects were a main element of these meetings.

The "Computation of Station Positions and EOPs" Pilot Project deals with these two fundamental analysis products of ILRS. One of the goals is the development of a unique, best-possible (in terms of quality) analysis product that can be used by the widest possible science community.

This project has kept its steady development pace during the reporting period. At the end of 2002, the ILRS released an official Call for Participation to its analysis members, soliciting contributions for an official ILRS combination product. This product covers solutions for daily EOPs (x-pole, y-pole and LOD) and station coordinates (once per analysis interval), and is based on a weekly analysis of SLR data on the LAGEOS and Etalon satellites. The EOPs are given with respect to the ITRF2000 reference frame and the station position solutions are unconstrained. An official test campaign, essentially a full-scale workout of the operational data and products flow, was initiated in the middle of 2003 and has since been running continuously. Initially, the data analyses covered 28-day periods each. However, during 2003 the IERS (a major

customer for ILRS products) started its Combination Pilot Project, which solicited specific input (station coordinates and EOPs) from the Technique Centers on a weekly basis. Consequently, during the AWG meeting in Kötzing it was decided to change to seven time intervals.

At this moment, five SLR analysis groups (ASI, DGFI, GFZ, JCET and NSGF) provide direct input for this products. ASI, DGFI and NCL have in addition been working on the combination of these individual solutions. The results of the project were evaluated during the AWG meeting in San Fernando (cf. the minutes of this meeting for more detailed information). The five contributors were acknowledged and given an official status (other, future contributors may also qualify; see below). In addition, ASI was selected as the official ILRS primary combination center, and DGFI was selected as the official ILRS backup combination center, each for a two-year term. As well as the contributors of individual solutions, these combination centers must follow strict timelines and provide routine products of the highest possible quality. Weekly, official ILRS products from these two combination centers are now available in SINEX format each Wednesday at CDDIS and EDC. Analysis centers will again compete for the ILRS combination and backup center in mid-2006, at the International Laser Ranging Workshop in Australia. All groups are encouraged to develop (the quality of) their contributions further.

The “Software Benchmarking” Pilot Project is aimed at quality control of the software in use at the various analysis centers for analysis results (orbits, parameters). The goal of this project is to make sure that the various software packages are free of errors as well as requiring other analysis groups to test their software prior to applying to become regular contributors to the official products. In the reporting period, this project has converged on the elements that lend themselves best for this purpose (a wide range of products, using different constraints and requirements, was defined initially). At this moment, two different 28-day intervals are defined for this particular purpose. For the first, nominal results are (should be) freely available, so that candidate contributors can inspect and QC their results themselves. The second 28-day period is meant for the independent evaluation by the AWG.

The third AWG Pilot Project for “Unification of Fast-Turnaround Analysis Results” is directed at the improvement of the station performance “quality verdict” in various semi real-time analysis results. Traditionally, such QC results are distributed in a rather uncoordinated way, i.e., each analysis center produces its own unique analysis report, which is then made available to customers (stations, satellite managers) typically without comparison or checking with results that are obtained by others. Here, the objective is to reduce possible inconsistencies among the various reports. A major aspect that played a crucial role here is the representation of station coordinates. Based on the findings of this pilot project, almost all analysis groups doing such real-time QC assessments have switched to ITRF2000 (with just one or two exceptions). Also, in the course of 2004 an initiative was taken to combine such QC results in a single report, which is available weekly at: [http://aiuas3.unibe.ch/ftp/slr/summary\\_report.txt](http://aiuas3.unibe.ch/ftp/slr/summary_report.txt).



---

# SECTION 8

## MODELING

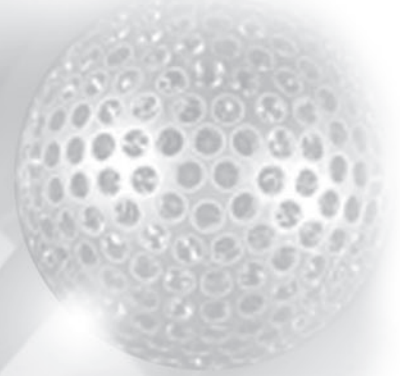



# SECTION 8

---

## MODELING

### Refraction Modeling

*Erricos Pavlis/JCET and Virgilio Mendes/U. Lisbon*

Atmospheric refraction modeling is one of the few remaining sources of limitation in accuracy in modern SLR. Recent improvements in this area include the development of mapping functions to project the atmospheric delay experienced in the zenith direction to a given elevation angle (Mendes et al., 2002). In a recent paper Mendes and Pavlis (2004) developed an updated zenith delay model from revised equations for the computation of the refractive index of the atmosphere, valid for a wide spectrum of optical wavelengths. The zenith total delay predicted with the new model and the new mapping function were initially tested against ray tracing with radiosonde data over an entire year of data, for 180 stations distributed worldwide, and showed sub-centimeter accuracy for the mapping function down to 3° elevation, and sub-millimeter for the zenith delay for wavelengths ranging from 0.355 mm to 1.064 mm. In a subsequent study, Hulley et al. (2004), further validated the new model with the use of ray tracing and in situ meteorological observations in various locations and conditions, obtained from NASA's AIRS instrument on-board the AQUA platform. These tests confirmed the previous results from radiosonde data, and they laid the foundation for an extension of the model to accommodate horizontal gradients in the lower atmosphere. A quantitative assessment of their effect suggests that for low elevations up to 15° their effect can be from a few millimeters to some centimeters. It also revealed a distinct behavior for locations inland vs. over the oceans. This will likely have significant implications for SLR sites located near the coastline.

### References

- Hulley, G., E.C. Pavlis, V.B. Mendes and D.E. Pavlis, (2004), "Validation of Atmospheric Refraction Modeling Improvements in Satellite Laser Ranging," *Eos Trans. AGU*, 85(47), Fall Meet. Suppl., Abstract G31A-0784.
- Mendes, V.B., G. Prates, E.C. Pavlis, D.E. Pavlis, and R.B. Langley, (2002), "Improved mapping functions for atmospheric refraction correction in SLR," *Geophysical Research Letters*, 29, 10, 1414, doi:10.1029/2001GL014394.
- Mendes, V.B., and E.C. Pavlis, (2004). "High-Accuracy Zenith Delay Prediction at Optical Wavelengths," *Geophysical Res. Lett.*, 31, L14602, doi:10.1029/2004GL020308.

### Satellite Center-Of-Gravity Corrections

*Graham Appleby/NSGF and Toshimichi Otsubo/NICT*

The accuracy with which laser range measurements to the laser reflector arrays of Earth satellites are referred to their centers of gravity is a further source of uncertainty that potentially limits the accuracy of the data. Lack of homogeneity in the ILRS tracking stations' hardware, average return energy regimes, and NP-generation procedures, especially the adopted clipping levels, is now understood to impact the value of the center of gravity correction at a level of up to 10mm for the primary geodetic satellite LAGEOS and at a higher level for the larger Etalon and Ajisai satellites (Otsubo and Appleby, 2003). To some degree, the effect is mitigated during data analysis by inclusion of station-constant range offsets in the solve-for parameter set. But this is not an ideal solution as it weakens the analysis and is to be avoided if at all possible.

In principle, the situation is self-evident; for those tracking stations able to detect single photons using avalanche photodiodes, the effective range measurement to the satellite will depend upon the relative location of detected photon within the returning packet of photons. A photon at the leading edge of the return results in a shorter range to the satellite than one near the trailing edge. In a situation of large numbers of returning photons, one near the leading edge will be statistically more likely to be detected than those arriving later, thus stations working at high return levels will measure short compared to those working at very low return level. Those stations designed to receive consistently high levels of return for detection using micro-channel plate devices are least prone to such systematic effects. However, the most unsatisfactory situation for all systems arises when the return energy varies greatly from pass to pass, or even within passes. In such cases, application of a fixed center of gravity correction or solution for a constant range offset is not appropriate, and corrections that are theoretically derived as functions of return level are required and are given in Otsubo and Appleby, (2003). This return-level effect has been demonstrated in the existing ILRS LAGEOS data (Otsubo, et al, 2004) and it is clear that for most ILRS stations return levels are quite variable over all timescales (Wilkinson et al, 2004).

This work suggests both that efforts in the field should be made to maintain constant return levels especially for the primary geodetic satellites where very accurate measurements are crucial, and that analysts should be aware of hardware-dependent center of mass corrections as given in Otsubo and Appleby (2003). Efforts continue to make these corrections available in a convenient form for use. Much information on center of gravity corrections and locations of laser reflector arrays on those satellites tracked by the ILRS network are given on the ILRS Web site at [http://ilrs.gsfc.nasa.gov/satellite\\_missions/center\\_of\\_mass/index.html](http://ilrs.gsfc.nasa.gov/satellite_missions/center_of_mass/index.html).

## **References**

- Otsubo, T. and G.M. Appleby, (2003). "System-dependent center-of-mass correction for spherical geodetic satellites." *J. Geophys. Res.* 108(B4), 2201, doi:10.1029/2002JB0022009.
- Otsubo, T. and G.M. Appleby, (2004). "Center of Mass Issues: Towards MM-Ranging Accuracy." in press, proc. 14th Int. Laser Ranging Workshop, San Fernando, Spain.
- Wilkinson, M., P. Gibbs and G.M. Appleby, (2004). "Return Energy Estimates Derived by Normal Point and Full-Rate Laser Data." in press, proc. 14th Int. Laser Ranging Workshop, San Fernando, Spain.

## **Improved LAGEOS Spin Axis Modeling**

*Nacho Andrés de la Fuente/DUT*

The satellites LAGEOS-1 and LAGEOS-2 are essential for the scientific study of various geophysical phenomena, such as geocenter motion and absolute scale. The high quality of such science products strongly depends on the absolute quality of the SLR observations and that of the orbit description. Therefore all accelerations experienced by the spacecraft need to be modeled as accurately as possible, the thermal radiation forces being one of them. This is traditionally accomplished by estimating so-called empirical accelerations. However, the rotational dynamics of LAGEOS-1 in particular no longer allows such a simple approach: a full modeling of the spin behavior, the temperature distribution over the spacecraft surface and the resulting net force prove necessary to achieve the best results. In a first step, Andrés et al. (2004) developed a new model: the LAGEOS Spin Axis Model (LOSSAM). It is unique in its combination of analytical theory and empirical observations. Its mathematics is taken after previous investigators, although flaws have been corrected. LOSSAM describes the full spin behavior of LAGEOS based on the following phenomena: (1) the geomagnetic field, (2) the Earth's gravity field, (3) the satellite center of pressure offset, and (4) the effective difference in reflectivity between the satellite hemispheres. Its accuracy has been demonstrated by an improvement of about a 50% in the RMS residual of

the Yarkovsky-Schach effect signal as shown by Lucchesi et al. (2004). Such a high-quality model for rotational behavior is indispensable for a proper force modeling, and hence also for the quality of typical LAGEOS science products.

### ***References***

- Andrés, J.I., R. Noomen, G. Bianco, D.G. Currie, and T. Otsubo (2004), Spin axis behavior of the LAGEOS satellites, *J. Geophys. Res.*, 109, B06403, doi:10.1029/2003JB002692.
- Lucchesi, D.M., I. Ciufolini, J.I. Andrés, E.C. Pavlis, R. Peron, R. Noomen, and D.G. Currie (2004), LAGEOS-II perigee rate and eccentricity vector excitations residuals and the Yarkovsky-Schach effect, *Planet. Space Sci.*, 52, 699-710, doi:10.1016/j.pss.2004.01.007.



---

# SECTION 9

## SCIENCE COORDINATION



FRASER PARKING







# SECTION 9

## SCIENCE COORDINATION

*Steve Klosko/RITSS, Erricos Pavlis/JCET, Mark Torrence/RITSS*

Satellite laser ranging continues to provide a critical resource to address many of the broad challenges facing space geodesy and geodynamics. SLR investigations have significantly contributed to the progress that has been made in isolating many important phenomena related to the state and sustainability of the Earth’s environment. Understanding the sources and magnitude of mass flux, defining a stable mm-level reference frame, and developing an integrated and interdependent understanding of the Earth’s system in four dimensions at increasingly detailed scales are major focus areas where SLR techniques contribute.

After nearly three decades wait, the CHAMP, GRACE and ICESat missions are providing an unprecedented set of measurements that challenge our abilities to optimally use these data to improve our understanding of the interrelationship within the solid earth, ocean, hydrological, and cryospheric systems. In each of these missions, and in our attempts to optimally exploit their data, SLR plays an important role.

The “decade of the geopotential” is upon us. It is and will continue providing a unique opportunity to more fully apply a broad range of improved orbit sensing systems to reveal details of the Earth’s static and time varying gravitational field, ocean circulation, hydrological cycles, magnetic field, seal level rise, and topographic change which were previously unobtainable. An order of magnitude greater accuracy and resolution was previously detectable with orbiting systems in the composite goal of these interrelated missions. SLR, as shown in Figure 9-1., has a significant role in each of the current and future missions within this multidisciplinary exploration. As laser single shot accuracy approaches 1 mm, the importance of SLR will increase in the calibration and independent verification of major science products from these missions.

**Role of SLR in the “Decade of the Geopotential”**

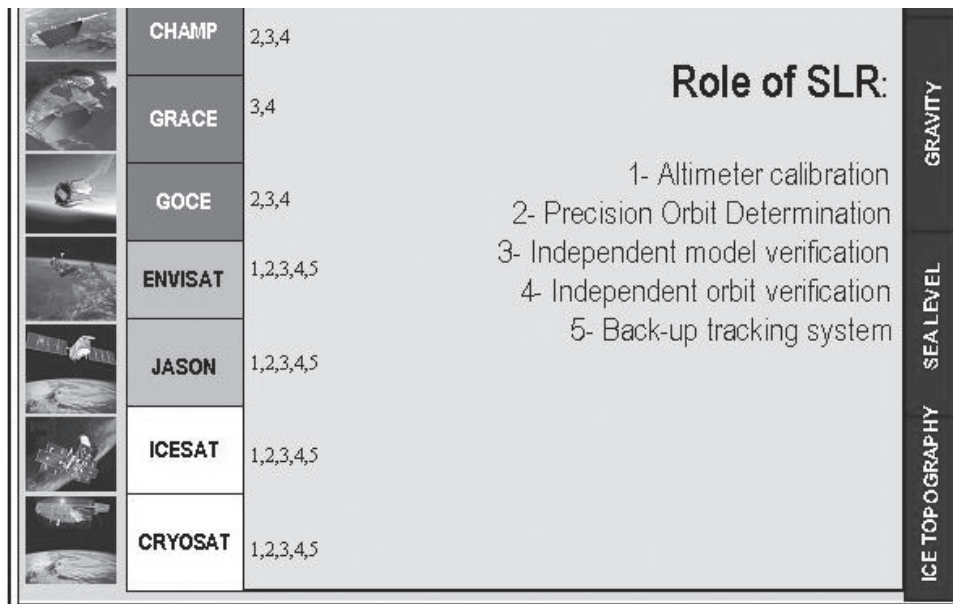

Figure 9-1. The “decade of the geopotential” is an international program of geodetic based missions.

Many of these missions are designed to improve our overall understanding of key questions remaining in the Earth Sciences, which have both surface height and mass transport manifestations (see Figure 9-2 below). SLR has proven to have unique sensitivity to station height and time varying gravity changes. These questions include:

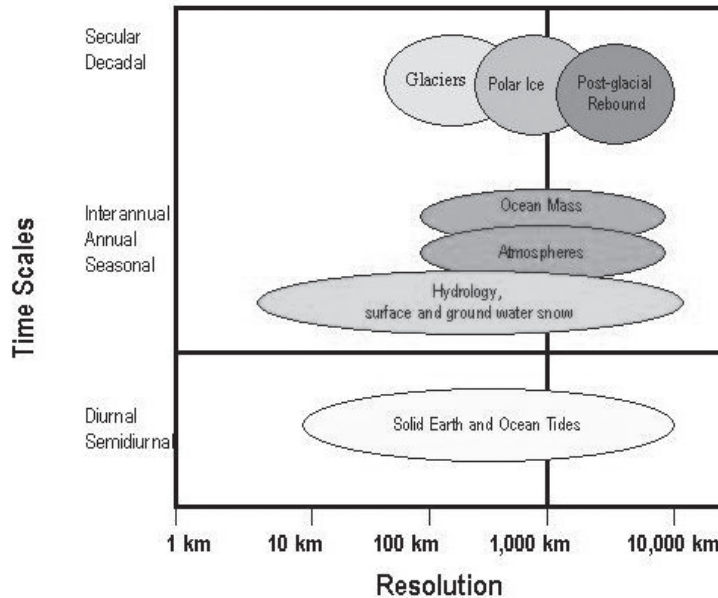

Figure 9-2. Mass flux within the Earth Systems occurs at various spatial and temporal scales.

As SLR data quality and quantity continue to improve, they will require improved analysis techniques and atmospheric refraction models to advance the science products coming from SLR and LLR. We can expect continued SLR contributions to:

- The implementation of the terrestrial reference frame (origin and scale in particular; both of which are accurate at an absolute level to a few mm)
- The long-wavelength geogravity field
- Observed temporal variations in the long wavelength gravity field useful as a form of remote sensing of mass flux in the environmental system
- Satellite altimetry (the observation of ocean currents, the absolute sea-level and variations therein and the absolute calibration of the altimeters themselves)
- Test specific elements of Einstein's General Law of Relativity
- Monitor earth rotation and orientation
- Improved understanding of Earth-moon interaction, lunar dynamics (such as librations), and exploration of exotic topics like g-dot

At the same time, great strides are being made in our understanding of aspects of planetary geophysics with the successful laser altimeter experiments on Mars Global Surveyor and Near Earth Asteroid Rendezvous missions. Mercury Messenger, Dawn, Lunar Reconnaissance Orbiter, and anticipated missions to the icy moons of Jupiter will all depend on laser altimeter systems.

Examples of two recent results from SLR demonstrate the continued importance of the Science contribution coming from the analysis of these data.

The experiment reported by Ciufolini and Pavlis (2004) was based on the long-term behavior of the argument of the ascending node of the LAGEOS-1 and LAGEOS-2 satellites. By evaluating more than 11 years of these data, Ignazio Ciufolini of the University of Lecce in Italy and Erricos Pavlis of the University of Maryland measured a value of the Lense Thirring effect that agrees within approximately 1% of that predicted by general relativity. Einstein's general relativity theory postulated several predictions, such as the advance of the perihelion of Mercury's orbit. Another prediction is that the rotation of a massive body like Earth will drag the local inertial frames of reference around it, which will thus affect the orbit of a satellite. This so-called Lense–Thirring effect, after the two Austrian physicists who pointed out the prediction in 1918, was accurately measured using laser-ranging data to the two LAGEOS satellites. The reported measurement from SLR data is  $99 \pm 5$  per cent of the value predicted by general relativity; the uncertainty of this measurement includes all known random and systematic errors, and it was made possible due to the availability of highly accurate gravitational models derived from NASA's GRACE mission. However, even if a 300% error were allowed for the accuracy estimates of the gravitational model used in the study, the error margin of the result is still at  $\pm 10$  per cent. The detection with an error of about 1 per cent is the main goal of NASA's Gravity Probe B, an ongoing space mission using ultra precise orbiting gyroscopes, and which is a regular SLR target.

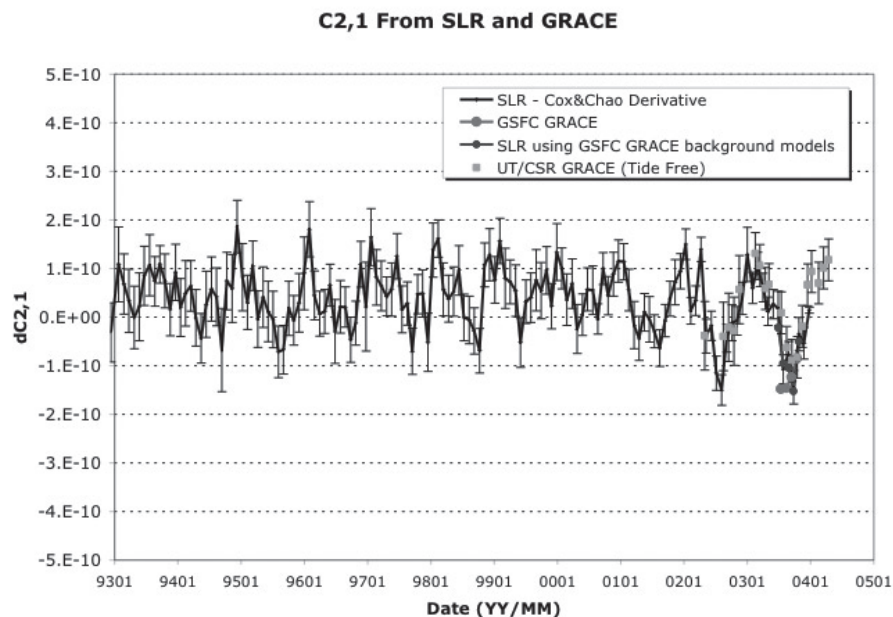

Figure 9-3. A Comparison of the time history of the C2,1 Stokes Coefficient from SLR and GRACE.

At a GRACE Science Team meeting, Cox and Chao presented their latest SLR time varying gravity solutions from the analysis of a complement of SLR satellites to mass motion being deduced from the direct analysis of the GRACE intersatellite K-band rate measurements. As shown in Figure 9-3 above, for certain long wavelength Stokes coefficients, the agreement between SLR and GRACE is remarkable. On the other hand, problems in the GRACE solution were quite evident in comparing the J2 harmonic obtained in the same ways. These results have proven to be of great interest to the GRACE Science Team where for example, estimates of mass balance over the Earth's ice sheets critically depends on the accurate modeling of Post Glacial Rebound, which is largely a J2-type effect.

As for the future, the ongoing trend towards higher accuracy, larger data volumes and the need to support more missions is expected to continue. The community is confident of reaching the absolute accuracy of one millimeter in a matter of years, with corresponding benefits for the international scientific community and our understanding of "System Earth". This unprecedented richness of coincident observations, including those coming from an international SLR network, offers a major challenge to both define and fully exploit the yet to be conceived insights they will offer.

## **References**

Ciufolini, I., E.C. Pavlis, “A confirmation of the general relativistic prediction of the Lense-Thirring effect”, *Nature*, 431, pp. 958-960, 21 Oct 2004.

---

# SECTION 10

## MEETINGS

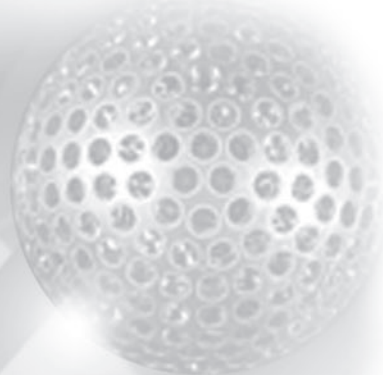



# SECTION 10

---

## MEETINGS

*Carey Noll/GSFC*

A workshop devoted to site co-location surveys was organized by the IERS and held in Matera Italy in October 2003; more information about the workshop can be found at [http://www.iers.org/workshop\\_2003\\_matera/](http://www.iers.org/workshop_2003_matera/). This meeting was followed by the fall 2003 ILRS workshop was held in Kötzing, Germany. This workshop focused on how the SLR community could work more effectively toward achieving the full potential of the SLR capability. Summary information from the workshop can be found on the ILRS Web site at [http://ilrs.gsfc.nasa.gov/reports/ilrs\\_reports/oct\\_2003\\_technical\\_workshop.html](http://ilrs.gsfc.nasa.gov/reports/ilrs_reports/oct_2003_technical_workshop.html). A technical meeting on kHz ranging was held in Graz, Austria in October 2004; information about this workshop can be found on the web at <http://khzslr.oeaw.ac.at/>. The Real Instituto y Observatorio de la Armada en San Fernando (Royal Naval Institute and Observatory at San Fernando, ROA) and the ILRS sponsored the 14th International Workshop on Ranging San Fernando, Spain during the week of June 07-11, 2004. The Web site <http://www.roa.es/14workshop-laser/> provides information about the workshop; proceedings and session summaries can also be found on the web at <http://cddis.gsfc.nasa.gov/lw14/>.

The ILRS organizes semi-annual meetings of the Governing Board and General Assembly. General Assembly Meetings are open to all ILRS associates and correspondents. The 9<sup>th</sup> ILRS General Assembly was held in April 2003 in Nice, France in conjunction with the Joint EGS-AGU-EUG meeting. The 10<sup>th</sup> ILRS General Assembly was held in June 2004 in San Fernando, Spain in conjunction with the 14th International Workshop on Laser Ranging. Detailed reports from past meetings can be found at the ILRS Web site.

## ILRS Technical Workshop, Kötzing, Germany

*Ulrich Schreiber/TU. Muenchen*

An ILRS workshop was held in Kötzing Germany on October 28-31, 2003 with the theme “Working toward the full potential of the SLR capability”. The goal of this meeting was to critically review practices and system designs of the SLR stations in the ILRS in order to improve the performance of the entire network.



*Figure 10-1. ILRS Governing Board Chair, Werner Gurtner, introducing the goals of the ILRS workshop.*

The workshop was opened by a presentation from Markus Rothacher, outlining the special role of SLR in view of inter-technique combinations. The basic format of this meeting was a continuation of similar workshops in London, Florence, and Toulouse. Important issues of the SLR technique were raised in a plenary discussion forum. The sections covered in this meeting were:

1. Operations
  - Station performance and data throughput
  - Daylight ranging
  - Implementation of the new Engineering Data File
  - Local survey monumentation and eccentricity measurement
  - Improved data QC at the stations
  - Dynamic priorities
  - System calibration
  - Refraction modeling
2. Modeling
  - LEO data submission – how fast is fast enough?
  - Spacecraft center-of-mass modeling
  - Two-wavelength tracking



3. Analysis

- Pilot projects
- New approaches
- kHz ranging and its impact

4. New Technologies

- SLR 2000
- Automation

After a brief introduction from each session chairman all subjects were discussed and well identified action items resulted from each session. The identified action items were reviewed again at the 14<sup>th</sup> International Workshop on Laser Ranging in San Fernando in June 2004.

More than 65 international attendees were present and participated in lively discussions, including representatives from most stations and analysis centers. A meeting of the ILRS Governing Board was also held in conjunction with this workshop. The meeting reports can be accessed through the ILRS Web site at: [http://ilrs.gsfc.nasa.gov/reports/ilrs\\_reports/oct\\_2003\\_technical\\_workshop.html](http://ilrs.gsfc.nasa.gov/reports/ilrs_reports/oct_2003_technical_workshop.html).

## 14<sup>th</sup> International Workshop on Laser Ranging, San Fernando Spain

*Michael Pearlman/CfA*



*Figure 10-2. Attendees of the 14th International Workshop on Laser Ranging at the ROA.*

The Real Instituto y Observatorio de la Armada en San Fernando (Royal Naval Institute and Observatory at San Fernando, ROA) and the ILRS sponsored the 14<sup>th</sup> International Workshop on Ranging in San Fernando, Spain during the week of June 07-11, 2004. Nearly 100 people from 20 countries participated in the workshop, which included oral and poster presentations on scientific achievements, applications and future requirements, system hardware and software, operations, advanced systems, and analysis. Sessions were organized around the following topics:

- Scientific Achievements, Applications, and Future Requirements
- Laser Technology
- Ranging Receivers
- Automation and Control Systems
- Improved and Upgraded Systems (posters)
- Lunar Laser Ranging
- Engineering and Q/C Analysis
- System Calibration Techniques
- Targets, Signatures and Biases

- Atmospheric Correction and Multiwavelength Ranging
- Advanced Systems and Techniques
- Operational Issues

Some of the key items of interest were:

- Emergence of the new IAG GGOS Project;
- Extracting of geophysical parameters through long-term monitoring of SLR data;
- Success of the new kilohertz ranging systems;
- Implementation of automated and remote control operations;
- New refraction model that is ready for implementation;
- On-line prediction update and station status reporting facilities;
- Procedures for avoiding damage to vulnerable satellite-borne optical detection systems;
- Continued work on the two-color systems.

Proceedings from the workshop will be available in early 2005 in hardcopy and on the web at <http://cddis.gsfc.nasa.gov/lw14/>. Session summaries from the workshop can also be found on this Web site. More details about the workshop, as well as abstracts for the workshop papers, can be found at the Web site <http://www.roa.es/14workshop-laser/>.

The French FTLRS system was in co-location with the San Fernando SLR system during the workshop. The attendees were treated to a pleasant evening of simultaneous operations and refreshments at the ROA.

As decided at the 13<sup>th</sup> Workshop on Laser Ranging in Washington D.C. in 2002, the next laser workshop will be held in Canberra Australia, October 16-20, 2006.

## kHz SLR Meeting, Graz, Austria

*Georg Kirchner, Franz Koidl/Austrian Academy of Sciences*

More than forty participants visited “the finest four-letter-town” of Austria (which is of course GRAZ, and not WIEN J), for the kHz SLR meeting at the Space Research Institute of the Austrian Academy of Sciences. The main goals of the meeting were the exchange of and discussions about all the necessary technical details for kHz ranging. In addition, we were lucky enough to have good weather at the end of the first day, and could demonstrate day and night kHz SLR to GPS-36, LAGES-2, Stella, etc.

The main topics discussed during the meeting were:

- kHz lasers; information about available products and technical details from HighQLaser
- Event Timers for kHz SLR: the new Riga Event Timer, E.T.s with Dassault Modules, etc.
- Range Gate Generators: various concepts, ideas, the Graz version
- Other related hardware items
- Software for kHz; operating systems
- Handling kHz returns: identification of single retro tracks, robust estimation, etc.

The Graz kHz SLR has been operational for one year. SLR2000 has successfully started first tests. Several other institutions are now switching to – or planning/considering – kHz SLR. The Herstmonceux station has already ordered the major parts. The Wettzell station is building a two-color/1 kHz system. Several 300-Hz stations are being build in Russia. We hope that the Graz kHz meeting will stimulate even more stations to consider a kHz upgrade – it is really worth doing it.

The presentations shown during this kHz meeting are available online at: <http://khzslr.oeaw.ac.at/presentations.htm>.

Please keep always in your mind,  
what during last months we did find:  
KiloHertz is lot of fun!  
(At least if all the work is done ☺)

There is no reason, why to wait -  
Increase your repetition rate !!!

---

# SECTION 11

## BIBLIOGRAPHY

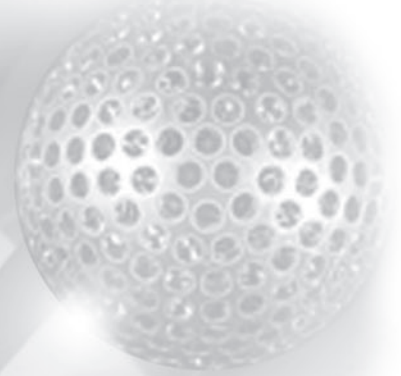

FRASER PANGLOSS



11





# SECTION 11

## BIBLIOGRAPHY

*Mark Torrence/RITSS*

Following is a list of some papers and presentations about SLR based technological and scientific findings, which were made in 2003 and 2004:

- Abylchatova, N., V. Glotov, V. Mitrikas, M. Zinkovskiy, "MCC Analysis Procedure of the SLR Data Quality and Stations Performance", 14<sup>th</sup> International Laser Ranging Workshop, San Fernando, Spain, June 7-11, 2004.
- Appleby, G., P. Gibbs, D. Benham, C. Potter, R. Sherwood, V. Smith, M. Wilkinson, I. Bayer, "SGF Herstmonceux: Current Status and Future Upgrades", 14<sup>th</sup> International Laser Ranging Workshop, San Fernando, Spain, June 7-11, 2004.
- Appleby, G., T. Otsubo, "Laser Ranging as a Precise Tool to Evaluate GNSS Orbital Solutions (Poster)", 14<sup>th</sup> International Laser Ranging Workshop, San Fernando, Spain, June 7 - 11, 2004.
- Argus, D. F., R.G. Gordon, M.B. Heflin, C. Ma, R.J. Eanes, "Plate Motions From Space Geodesy", AGU Spring Meeting Abstracts A2, 2004.
- Arnold, D., G. Appleby, "LAGEOS' Asymmetric Reflectivity", 14<sup>th</sup> International Laser Ranging Workshop, San Fernando, Spain, June 7-11, 2004.
- Arnold, D., G. Kirchner, F. Koidl, "Identifying Single Retro Tracks with a 2 Khz SLR System-Simulations and Actual Results", 14<sup>th</sup> International Laser Ranging Workshop, San Fernando, Spain, June 7-11, 2004.
- Bartoszak, J., S. Schillak, "Modernization of the Borowiec SLR System", 14<sup>th</sup> International Laser Ranging Workshop, San Fernando, Spain, June 7-11, 2004.
- Bayer, I., P. Gibbs, M. Wilkinson, "Herstmonceux Time Bias System as A Possible Real-Time QC Tool", 14<sup>th</sup> International Laser Ranging Workshop, San Fernando, Spain, June 7-11, 2004.
- Benham, D., P. Gibbs, V. Smith, "New Internal Calibration Target at SGF Herstmonceux; Design and Results", 14<sup>th</sup> International Laser Ranging Workshop, San Fernando, Spain, June 7-11, 2004.
- Berio, P., P. Exertier, F. Pierron, J. Weick, D. Coulot, O. Laurain, P. Bonnefond, "FTLRS laser staff, FTLRS Support to the Gavdos Project: Tracking and Positioning", 14<sup>th</sup> International Laser Ranging Workshop, San Fernando, Spain, June 7 - 11, 2004.
- Beutler, G., T. Schildknecht, U. Hugentobler, W. Gurtner, "Orbit determination in satellite geodesy, Advances in Space Research 31, 1853-1868, 2003.
- Bianco, G., R. Sala, V. Luceri, "MLRO Performance Characterization", 14<sup>th</sup> International Laser Ranging Workshop, San Fernando, Spain, June 7-11, 2004.
- Bolotina, O. V., M.M. Medvedskii, V.R. Suberlyak, "On stability of the "Golosiiv-Kiev" satellite laser ranging station, Kinematika i Fizika Nebesnykh Tel 19, 77-86, 2003.
- Bolotina, O., Y. Glushchenko, M. Medvedskij, M. Peretyatko, V. Suberlyak, D. Yatskiv, "SLR station 'Golosiiv-Kiev': current state and activity", Journees 2001 - systemes de reference spatio-temporels. Influence of geophysics, time and space reference frames on Earth rotation studies, Brussels, 24-26 September 2001, edited by N. Capitaine. Observatoire de Paris, Systemes de Reference Temps-Espace, UMR 8630/CNRS; Observatoire Royal de Belgique, ISBN 2-901057-46-, 2003, p. 207 - 213 13, 207-213., 2003.
- Carman, R., V. Noyes, T. Otsubo, "Centre-of-Mass Correction Issues: Determining Intensity Dependency at a Multi-Photon (Moblas-5) Station." 14<sup>th</sup> International Laser Ranging Workshop, San Fernando, Spain, June 7-11, 2004.
- Celka, T., S. Schillak, "Range bias in Borowiec satellite laser ranging system," Artificial Satellites 38, 29-35, 2003.
- Chandler, J., M. Pearlman, R. Reasenberg, J. Degnan, "Solar-System Dynamics and Tests of General Relativity with Planetary Laser Ranging", 14<sup>th</sup> International Laser Ranging Workshop, San Fernando, Spain, June 7 - 11, 2004.
- Chao, B.F., J.-P. Boy, C. Cox, A. Au, "Time-variable gravity signal due to extratropic Pacific water mass redistribution", EGS-AGU-EUG Joint Assembly, Abstracts from the meeting held in Nice, France, 6 - 11 April 2003.
- Chao, B.F., C.M. Cox, "Interannual Variations in Earth's Low-Degree Gravity Field and the Connections With Geophysical/ Climatic Changes", AGU Spring Meeting Abstracts A5, 2004.

- Chen, J., C. Wilson, "Independent Determination of Low Degree Gravitational Changes From Earth Rotation and Geophysical Models", AGU Fall Meeting Abstracts A729, 2003.
- Cheng, M.K., M. Fang, B.H. Hager, B.D. Tapley, "Geodynamic effects of glacial isostasy from space geodetic observations", EGS-AGU-EUG Joint Assembly, Abstracts from the meeting held in Nice, France, 6 - 11 April 2003.
- Cheng, M., B.D. Tapley, "Secular variations in the low degree zonal harmonics from 28 years of SLR data", AGU Fall Meeting Abstracts 801, 2004.
- Cheng, M., B.D. Tapley, "Variations in the Earth's Oblateness During the Past 26 years", AGU Fall Meeting Abstracts 2, 2003.
- Cheng, M., B.D. Tapley, "Variations in the Earth's oblateness during the past 28 years", Journal of Geophysical Research (Solid Earth) 9402, 2004.
- Chengzhi, L., Z. You, F. Cunbo, H. Xingwei, Z. Xinghua, S. Jianyong, Z. Haitao, "The Performance of Changchun Satellite Laser Ranging Station", 14<sup>th</sup> International Laser Ranging Workshop, San Fernando, Spain, June 7 - 11, 2004.
- Chin, T. M., R.S. Gross, J.O. Dickey, "Multi-reference Evaluation of Uncertainty in Earth Orientation Parameter Measurements", AGU Fall Meeting Abstracts 312, 2003.
- Chu-Gang, F., Z. Yuan-Ian, Z. Fei-Peng, "Determination of EOPs with combined SLR data of LAGEOS-1 and LAGEOS-2", Chinese Astronomy and Astrophysics 27, 357-364, 2003.
- Ciufolini, I., E.C. Pavlis, "A confirmation of the general relativistic prediction of the Lense-Thirring effect", Nature, 431, pp. 958-960, 21 Oct 2004.
- Combrinck, L., "Proposed International Institute for Space Geodesy and Earth Observation (Poster)", 14<sup>th</sup> International Laser Ranging Workshop, San Fernando, Spain, June 7 - 11, 2004.
- Coulot, D., P. Berio, P. Exertier, O. Laurain, "Time series of Satellite Laser Ranging station positions, SF2A-2003: Semaine de l'Astrophysique Francaise 51, 2003.
- Coulot, D., P. Berio, P. Exertier, "Time Series of Satellite Laser Ranging Station Position (Poster)", 14<sup>th</sup> International Laser Ranging Workshop, San Fernando, Spain, June 7 - 11, 2004.
- Coulot, D., R. Biancale, P. Berio, A.-M. Gontier, S. Loyer, L. Soudarin, J.-M. Lemoine, Z. Altamimi, N. Capitaine, P. Exertier and D. Gambis, "Combination of Space Geodesy Techniques for Monitoring the Kinematics Of The Earth", 14<sup>th</sup> International Laser Ranging Workshop, San Fernando, Spain, June 7 - 11, 2004.
- Cox, C.M., A. Au, J.-P. Boy, B. Chao, "Comparison of oceanographic signals with SLR-derived gravity observations", Proceedings of the IERS Workshop on Combination Research and Global Geophysical Fluids, Bavarian Academy of Sciences, Munich, Germany, 18-21 November 2002. Ed. by Bernd Richter, Wolfgang Schwegmann, and Wolfgang R. Dick, International Earth Rotation and Reference Systems Service (IERS). IERS Technical Note, No. 30, Frankfurt am Main, Germany: Verlag des Bundesamtes fur Kartographie und Geodesie, ISBN 3-89888-877-, 2003, p. 139 - 143 139-143., 2003.
- Cox, C.M., B.F. Chao, "Ice mass balance inferred from recent satellite laser ranging estimates of gravity changes", EGS-AGU-EUG Joint Assembly, Abstracts from the meeting held in Nice, France, 6 - 11 April 2003.
- Cox, C.M., B.F. Chao, A. Au, J.-P. Boy, "Analysis of sectorial and tesseral time variation in the earth's gravity field and the correlation with environmental factors", EGS-AGU-EUG Joint Assembly, Abstracts from the meeting held in Nice, France, 6 - 11 April 2003, abstract #4598, 2003.
- Cox, C.M., B.F. Chao, A. Au, J.-P. Boy, "Time-Variable Gravity From Satellite-Laser-Ranging and Doppler Measurements: An Update on the Low-Degree Components as Well as the Connections With Geophysical/Climatic Processes", AGU Fall Meeting Abstracts 1, 2003.
- Cox, C.M., F.G. Lemoine, S.B. Luthcke, D.D. Rowlands, B.F. Chao, "Time-Variable Gravity From Satellite Laser Ranging and Doppler Measurements: A look at the interannual and annual variations and comparison with GRACE results", AGU Fall Meeting Abstracts A4, 2004.
- Cox, C., B. Chao, A. Au, "Interannual and Annual Variations in the Geopotential Observed Using SLR", 14<sup>th</sup> International Laser Ranging Workshop, San Fernando, Spain, June 7 - 11, 2004.
- Dawson, J., G. Johnston, S. Naebkhil, R. Govind, "The Mount Stromlo Satellite Laser Ranging (SLR) System Local Tie Connections before and after The 2003 Destructive Canberra Fires", 14<sup>th</sup> International Laser Ranging Workshop, San Fernando, Spain, June 7-11, 2004.
- Degnan, J., A Compact, "Totally Passive, Multi-Pass Slab Laser Amplifier Based on Stable, Degenerate Optical Resonators", 14<sup>th</sup> International Laser Ranging Workshop, San Fernando, Spain, June 7-11, 2004.
- Degnan, J., A. Seas, H. Donovan, T. Zagwodzki, "SLR2000C: An Autonomous Satellite Laser Ranging and Space-To-Ground Optical Communications Facility", 14<sup>th</sup> International Laser Ranging Workshop, San Fernando, Spain, June 7-11, 2004.



- Degnan, J., "Ray Matrix Approach for the Real Time Control of SLR2000 Optical Elements", 14<sup>th</sup> International Laser Ranging Workshop, San Fernando, Spain, June 7-11, 2004.
- Drewes, H., Ch. Reigber, "The Global Geodetic Observing System (GGOS) in its Initial Phase", 14<sup>th</sup> International Laser Ranging Workshop, San Fernando, Spain, June 7-11, 2004.
- Dunn, P., M. Torrence, R. Kolenkiewicz, D. Smith, "Observations of Surface Forces on the LAGEOS Satellites", EGS-AGU-EUG Joint Assembly, Abstracts from the meeting held in Nice, France, 6 - 11 April 2003, abstract #7162, 2003.
- El-Saftawy, M., M. Ibrahim, "The Laser Orbital Perturbation (Poster)", 14<sup>th</sup> International Laser Ranging Workshop, San Fernando, Spain, June 7 - 11, 2004.
- Elango, K., P. Soma, S.K. Shivakumar, "Indian Interest On SLR", 14<sup>th</sup> International Laser Ranging Workshop, San Fernando, Spain, June 7-11, 2004.
- Femenias, P.F., "ESA EO Envisat and Cryosat Missions Status (Poster)", 14<sup>th</sup> International Laser Ranging Workshop, San Fernando, Spain, June 7-11, 2004.
- Feng, C.G., F.P. Zhang, Y.L. Zhu, "Determination of LAGEOS satellite's precise orbits and residual analysis", *Acta Astronomica Sinica* 44, 55-64, 2003.
- Feng, C.G., Y.L. Zhu, F.P. Zhang, "The determination of EOP from the SLR data of combining LAGEOS1 and LAGEOS2", *Acta Astronomica Sinica* 44, 189-196, 2003.
- Fernandez-Ibanez, F., J.I. Soto, J. Morales, C. Comas, K. Evans, E.C. Pavlis, M.P. Cadeddu, S.P. Mertikas, "Tectonic Motion Monitoring at the Altimeter Calibration Facility on Gavdos, Crete, Greece", AGU Fall Meeting Abstracts 482, 2004.
- Fugate, R. Q., "The Starfire Optical Range 3.5-m Adaptive Optical Telescope, Large Ground-based Telescopes. Edited by Oschmann, Jacobus M.; Stepp, Larry M., Proceedings of the SPIE, Volume 4837, pp. 934-943, 2003.
- Fumin, Y., C. Wanzhen, Z. Zhongping, C. Juping, W. Yuanming, "Design of Laser Retro-Reflector Array and Laser Ranging Experiment for Shenzhou-IV Satellite", 14<sup>th</sup> International Laser Ranging Workshop, San Fernando, Spain, June 7-11, 2004.
- Fumin, Y., Z. Zhongping, C. Wanzhen, L. Xin, C. Juping, W. Bin, "Time Transfer by Laser Pulses between Ground Stations", 14<sup>th</sup> International Laser Ranging Workshop, San Fernando, Spain, June 7-11, 2004.
- Galkin, Y., S. Stryukov, R. Tatevyan, "The Correction of SLR Data by the Nonlinear Dispersion of the Refraction Index of the Air", 14<sup>th</sup> International Laser Ranging Workshop, San Fernando, Spain, June 7-11, 2004.
- Garate, J., J. Martin Davila, M. Quijano, C. Belza., "San Fernando SLR Status and Future Objectives", 14<sup>th</sup> International Laser Ranging Workshop, San Fernando, Spain, June 7 - 11, 2004.
- Gonzalez, F.J., A. Pazos, "ROA: 250 years working in Astronomy and Geophysics (1753-2003) (Poster)", 14<sup>th</sup> International Laser Ranging Workshop, San Fernando, Spain, June 7-11, 2004.
- Govind, R., Geoscience Australia Long Term SLR Series (Poster)", 14<sup>th</sup> International Laser Ranging Workshop, San Fernando, Spain, June 7 - 11, 2004.
- Govind, R., "Gravity Model Comparisons Using SLR", 14<sup>th</sup> International Laser Ranging Workshop, San Fernando, Spain, June 7 - 11, 2004.
- Greene, B., C. Smith, Y. Gao, J. Cotter, C. Moore, I. Ritchie, C. Burman, "Advanced Techniques at the EOS Space Research Centre", 14<sup>th</sup> International Laser Ranging Workshop, San Fernando, Spain, June 7-11, 2004.
- Greene, B., C. Smith, Y. Gao, J. Cotter, C. Moore, J. Luck, I. Ritchie, "Lunar Ranging from Mount Stromlo", 14<sup>th</sup> International Laser Ranging Workshop, San Fernando, Spain, June 7 - 11, 2004.
- Greene, B., C. Smith, Y. Gao, J. Cotter, C. Moore, R. Brunswick, C. Burman, "The New Mount Stromlo SLR System", 14<sup>th</sup> International Laser Ranging Workshop, San Fernando, Spain, June 7-11, 2004.
- Gurtner, W., "Die Fundamentalstation Zimmerwald", *Orion* 316, 36-40, 2003.
- Gurtner, W., "EUROLAS Real Time Status Exchange", 14<sup>th</sup> International Laser Ranging Workshop, San Fernando, Spain, June 7-11, 2004.
- Gurtner, W., Zimmerwald "Remote Control By Internet And Cellular Phone", 14<sup>th</sup> International Laser Ranging Workshop, San Fernando, Spain, June 7-11, 2004.
- Mueller, H., D. Angermann, B. Meisel, "A Multi Year SLR Solution", 14<sup>th</sup> International Laser Ranging Workshop, San Fernando, Spain, June 7-11, 2004.
- Haines, B., Desai, S., Willis, P., Bertiger, W., Munson, T., "Precise orbit determination for Jason-1: GPS and the 1-cm challenge", EGS-AGU-EUG Joint Assembly, Abstracts from the meeting held in Nice, France, 6 - 11 April 2003.
- Hamal, K., Ivan Prochazka, "Portable Pico Event Timer 2 Khz", 14<sup>th</sup> International Laser Ranging Workshop, San Fernando, Spain, June 7-11, 2004.
- Hamal, K., Tea, "Satellite laser ranging Portable Calibration Standard missions 1997-2002", EGS-AGU-EUG Joint Assembly, Abstracts from the meeting held in Nice, France, 6 - 11 April 2003.

- Han, S., C. Shum, C. Jekeli, C. Kuo, A. Braun, "Static and time-variable Earth gravity fields from CHAMP and GRACE", AGU Fall Meeting Abstracts A4, 2003.
- He, M., X. Zheng, C. Jiang, "The detectors of satellite laser ranging in Yunnan Observatory, Publications of the Yunnan Observatory 96, 62-68, 2003.
- Hulley, G., E. Pavlis, V. Mendes, D. Pavlis, "Multiwavelength Refraction Modeling Improvements for SLR Observations", 14<sup>th</sup> International Laser Ranging Workshop, San Fernando, Spain, June 7-11, 2004.
- Hulley, G., E.C. Pavlis, V.B. Mendes, D.E. Pavlis, "Validation of Atmospheric Refraction Modeling Improvements in Satellite Laser Ranging", AGU Fall Meeting Abstracts A784, 2004.
- Husson, V. S., J.C. Ries, R.J. Eanes, J.E. Horvath, "Millimeter QC of the ITRF using SLR", AGU Fall Meeting Abstracts 308, 2003.
- Iorio, L., I. Ciufolini, E.C. Pavlis, S. Schiller, H. Dittus, C. Lammerzahn, "On the possibility of measuring the Lense Thirring effect with a LAGEOS LAGEOS II OPTIS mission", *Classical and Quantum Gravity* 21, 2139-2151, 2004.
- Iorio, L., "Letter: A Reassessment of the Systematic Gravitational Error in the LARES Mission", *General Relativity and Gravitation* 35, 1263-1272, 2003.
- Iorio, L., "On a New Observable for Measuring the Lense-Thirring Effect with Satellite Laser Ranging", *General Relativity and Gravitation* 35, 1583-1595, 2003.
- Iorio, L., "Some comments on a recent paper on the impact of the secular variations of the even zonal harmonics on the Lense-Thirring tests with the LAGEOS satellites", ArXiv General Relativity and Quantum Cosmology e-prints gr-qc/0412057, 2004.
- Iorio, L., "The Impact of the Static Part of the Earth's Gravity Field on Some Tests of General Relativity with Satellite Laser Ranging", *Celestial Mechanics and Dynamical Astronomy* 86, 277-294, 2003.
- Iorio, L., "Towards a few-percent measurement of the Lense-Thirring effect with the LAGEOS and LAGEOS II satellites?", ArXiv General Relativity and Quantum Cosmology e-prints gr-qc/0408031, 2004.
- Ivins, E.R., X. Wu, E. Rignot, T.S. James, "Mass Balance of Antarctica and Predicted Gravity and Geoid Change Signatures with Implications for the Secular Zonal Harmonic Budget", EGS-AGU-EUG Joint Assembly, Abstracts from the meeting held in Nice, France, 6 - 11 April 2003, abstract #12640, 2003.
- Kang, Z., P. Nagel, R. Pastor, "Precise orbit determination for GRACE", *Advances in Space Research* 31, 1875-1881, 2003.
- Kirchner, G., F. Koidl, "Graz KHz SLR System: Design, Experiences and Results", 14<sup>th</sup> International Laser Ranging Workshop, San Fernando, Spain, June 7-11, 2004.
- Koenig, R., C. Reigber, K.H. Neumayer, R. Schmidt, S. Zhu, G. Baustert, F. Flechtner, H. Meixner, Satellite dynamics of the CHAMP and GRACE leos as revealed from space- and ground-based tracking, *Advances in Space Research* 31, 1869-1874, 2003.
- Kral, L., I. Prochazka, G. Kirchner, F. Koidl, "Atmospheric Contribution to the Laser Ranging Jitter", 14<sup>th</sup> International Laser Ranging Workshop, San Fernando, Spain, June 7-11, 2004.
- Kral, L., I. Prochazka, J. Blazej, K. Hamal, "Satellite laser ranging precision ultimate limit", *Laser Radar Technology for Remote Sensing*. Edited by Werner, Christian. Proceedings of the SPIE, Volume 5240, pp. 26-30, 2004.
- Lara, M., "A New Approach for Mission Design for Geodetic Satellites", 14<sup>th</sup> International Laser Ranging Workshop, San Fernando, Spain, June 7-11, 2004.
- Lee, J.H., S.B. Kim, K.H. Kim, S.H. Lee, Y.J. Im, Y. Fumin, C. Wanzhen, "Korea's First Satellite for Satellite Laser Ranging", 14<sup>th</sup> International Laser Ranging Workshop, San Fernando, Spain, June 7-11, 2004.
- Lemoine, J.-M., R. Biancale, G. Bourda, "Processing 18.6 Years of LAGEOS Data", 14<sup>th</sup> International Laser Ranging Workshop, San Fernando, Spain, June 7-11, 2004.
- Lucchesi, D.M., "LAGEOS II perigee shift and Schwarzschild gravitoelectric field", *Physics Letters A* 318, 234-240, 2003.
- Lucchesi, D.M., "LAGEOS Satellites Asymmetric Reflectivity Effect and the Germanium Cube Corner Retroreflectors", EGS-AGU-EUG Joint Assembly, Abstracts from the meeting held in Nice, France, 6 - 11 April 2003.
- Lucchesi, D.M., "The asymmetric reflectivity effect on the LAGEOS satellites and the germanium retroreflectors", *Geophysical Research Letters* 30, 11-1, 2003.
- Luceri, V., C. Sciarretta, G. Bianco, "Long Term Monitoring of Geophysical Parameters Using SLR", 14<sup>th</sup> International Laser Ranging Workshop, San Fernando, Spain, June 7-11, 2004.
- Luceri, V., R. Sala, C. Sciarretta, G. Bianco, "Estimation of time-varying geopotential coefficients using Satellite Laser Ranging data", AGU Fall Meeting Abstracts 799, 2004.
- Luck, J.McK., "Five Target System Calibration", 14<sup>th</sup> International Laser Ranging Workshop, San Fernando, Spain, June 7-11, 2004.

- Luck, J.McK., "Is Your Performance being Ruined by Interpolation Errors?", 14<sup>th</sup> International Laser Ranging Workshop, San Fernando, Spain, June 7-11, 2004.
- Luck, J.McK., "Mount Model Stability", 14<sup>th</sup> International Laser Ranging Workshop, San Fernando, Spain, June 7-11, 2004.
- Luthcke, S.B., D.D. Rowlands, C.C. Carabajal, D. Harding, J. Bufton, T. Williams, "ICESAT Laser Altimeter Pointing, Ranging and Timing Calibration from Integrated Residual Analysis", AGU Fall Meeting Abstracts 2, 2003.
- McGarry, J., T. Zagwodzki, J. Degnan, P. Dunn, J. Cheek, D. Patterson, H. Donovan, A. Mann, A. Mallama, R. Ricklefs, "Early Satellite Tracking Results from SLR2000", 14<sup>th</sup> International Laser Ranging Workshop, San Fernando, Spain, June 7-11, 2004.
- Mendes, V.B., E.C. Pavlis, "High-accuracy zenith delay prediction at optical wavelengths", Geophysical Research Letters 31, 14602, 2004.
- Mertikas, S., K. Palamartchouk, T. Papadopoulos, X. Frantzis, E. Koutroulis, "Sea level and ground monitoring at the radar altimeter calibration site of GAVDOS", EGS-AGU-EUG Joint Assembly, Abstracts from the meeting held in Nice, France, 6 - 11 April 2003.
- Montojo, F.J., J. Nunez, O. Fors, M. Merino, J.L. Muiños, F. Belizón, M. Vallejo, J.M. Codina, "San Fernando Baker-Nunn Camera Transformation", 14<sup>th</sup> International Laser Ranging Workshop, San Fernando, Spain, June 7-11, 2004.
- Moore, P., Z. Qiang, S. Crisp, "Geodynamical Inferences from CHAMP: orbits and gravity field", EGS-AGU-EUG Joint Assembly, Abstracts from the meeting held in Nice, France, 6 - 11 April 2003, abstract #3814, 2003.
- Moore, P., J. Wang, "Geocentre variation from laser tracking of LAGEOS1/2 and loading data", Advances in Space Research 31, 1927-1933, 2003.
- Moratalla, T.L., C. Abad, F. Belizon, J.C. Coma, F.J. Montojo, J.L. Muiños, J. Palacio, M. Vallejo, "The PASAGE Project. Astrometric Positioning of Geostationary Satellites (Poster)", 14<sup>th</sup> International Laser Ranging Workshop, San Fernando, Spain, June 7 - 11, 2004.
- Mueller, H., "Results of the SLR Tracking Data Quality Control During the Operational Processing", 14<sup>th</sup> International Laser Ranging Workshop, San Fernando, Spain, June 7-11, 2004.
- Mulacova, J., K. Hamal, G. Kirchner, F. Koidl, "Effects of the Atmosphere on the SLR Precision", 14<sup>th</sup> International Laser Ranging Workshop, San Fernando, Spain, June 7-11, 2004.
- Murphy, T., "The Apache Point Observatory Lunar Laser Ranging Operation (APOLLO)", 14<sup>th</sup> International Laser Ranging Workshop, San Fernando, Spain, June 7 - 11, 2004.
- Nagano, S., T. Yoshino, H. Kunimori, M. Hosokawa, S. Kawamura, T. Sato, M. Ohkawa, "Displacement measuring technique for satellite-to-satellite laser interferometer to determine Earth's gravity field", Measurement Science and Technology 15, 2406-2411, 2004.
- Nerem, R.S., P. Bender, B. Loomis, J. Geiple, M. Watkins, W. Folkner, M. Stephens, T. Delker, J. Leitch, R. Pierce, "Development of an Interferometric Laser Ranging System for a Follow-On Gravity Mission to GRACE", AGU Fall Meeting Abstracts A787, 2004.
- Nerem, R.S., P. Bender, M. Watkins, W. Folkner, M. Stephens, T. Delker, J. Leitch, R. Pierce, "Development of an Interferometric Laser Ranging System for a Follow-On Gravity Mission to GRACE", AGU Spring Meeting Abstracts 2, 2004.
- Nerem, R.S., C. M. Cox, E.W. Leuliette, B.F. Thompson, "An Investigation of Recent Gravity Variations Using Geophysical 'Fingerprints'", AGU Fall Meeting Abstracts 6, 2003.
- Nerem, R.S., Leuliette, R.S. Gross, A. Cazenave, J.M. Lemoine, D.P. Chambers, "Causes of Recent Observed Changes in the Earth's Oblateness", EGS-AGU-EUG Joint Assembly, Abstracts from the meeting held in Nice, France, 6 - 11 April 2003.
- Nicolas, J., J.M. Nocquet, M. Van Camp, J.P. Boy, J. Hinderer, M. Amalvict, P. Gegout, E. Calais, J.J. Walch, "Seasonal effects on Laser, GPS and absolute Gravimetry vertical positioning at the OCA-CERGA geodetic station, Grasse (France) (Poster)", 14<sup>th</sup> International Laser Ranging Workshop, San Fernando, Spain, June 7 - 11, 2004.
- Noll, C.E., M.P. Dube, "Archiving Space Geodesy Data for 20+ Years at the CDDIS", AGU Fall Meeting Abstracts A10, 2004.
- Noll, C., M. Dube, "CDDIS Archive Structure Supporting Laser Ranging Data and Products (Poster)", 14<sup>th</sup> International Laser Ranging Workshop, San Fernando, Spain, June 7-11, 2004.
- Noomen, R., "18 Years of Q/C Analysis at Delft University Of Technology", 14<sup>th</sup> International Laser Ranging Workshop, San Fernando, Spain, June 7-11, 2004.
- Noomen, R., S. Klosko, "Laser Ranging Workshop Draws International Research Community", EOS Transactions 84, 51-51, 2003.

- Oneto, J.-L., "Self-Mixing Optical Doppler Radial Velocity Measurements and Laser Link Budget: A Prospective Study", 14<sup>th</sup> International Laser Ranging Workshop, San Fernando, Spain, June 7-11, 2004.
- Otsubo, T., G.M. Appleby, "System-dependent center-of-mass correction for spherical geodetic satellites", *Journal of Geophysical Research (Solid Earth)* 108, 9-1, 2003.
- Otsubo, T., and G. Appleby, "Centre-of-Mass Correction Issues: Towards mm-Ranging Accuracy", 14<sup>th</sup> International Laser Ranging Workshop, San Fernando, Spain, June 7-11, 2004.
- Otsubo, T., T. Kubo-Oka, T. Gotoh, R. Ichikawa, "Atmospheric Loading Blue-Sky Effects on SLR Station Coordinates", AGU Fall Meeting Abstracts 793, 2004.
- Otsubo, T., R.A. Sherwood, P. Gibbs, R. Wood, "Determination of LAGEOS-2 spin from photometric observation: (2) Misalignment of reflectors and rotational direction", EGS-AGU-EUG Joint Assembly, Abstracts from the meeting held in Nice, France, 6 - 11 April 2003.
- Otsubo, T., T. Kubo-oka, T. Gotoh, R. Ichikawa, "Atmospheric Loading "Blue-Sky"; Effects on SLR Station Coordinates", 14<sup>th</sup> International Laser Ranging Workshop, San Fernando, Spain, June 7 - 11, 2004.
- Pavlis, E.C., S.P. Mertikas, K. Evans, "Sea Level, Tectonics, Environmental Monitoring and Altimeter Calibration in Eastern Mediterranean", AGU Fall Meeting Abstracts 284, 2003.
- Pavlis, E.C., "Satellite Laser Ranging Observations of the TRF Origin", AGU Fall Meeting Abstracts A3, 2003.
- Pavlis, E.C., "TRF Kinematics From Satellite Laser Ranging.", AGU Fall Meeting Abstracts 810, 2004.
- Pavlis, E., "Daily Earth orientation parameters from satellite laser ranging", EGS-AGU-EUG Joint Assembly, Abstracts from the meeting held in Nice, France, 6 - 11 April 2003.
- Pavlis, E., "Data Yield of the ILRS Global Network Over The Past Decade", 14<sup>th</sup> International Laser Ranging Workshop, San Fernando, Spain, June 7-11, 2004.
- Pavlis, E., "Earth Orientation Parameters from Satellite Laser Ranging (Poster)", 14<sup>th</sup> International Laser Ranging Workshop, San Fernando, Spain, June 7 - 11, 2004.
- Pavlis, E., S. Mertikas, "FTLRS Positioning for the EU/NASA Altimeter Calibration Project GAVDOS (Poster)", 14<sup>th</sup> International Laser Ranging Workshop, San Fernando, Spain, June 7 - 11, 2004.
- Pavlis, E., "SLR Contributions in the Establishment of the Terrestrial Reference Frame", 14<sup>th</sup> International Laser Ranging Workshop, San Fernando, Spain, June 7-11, 2004.
- Pavlis, E., "The impact of data from the new missions in the development of future gravity models", EGS-AGU-EUG Joint Assembly, Abstracts from the meeting held in Nice, France, 6 - 11 April 2003.
- Pavlis, E., "The origin of the TRF from satellite laser ranging", EGS-AGU-EUG Joint Assembly, Abstracts from the meeting held in Nice, France, 6 - 11 April 2003.
- Pavlis, E., "Time series of weekly TRF realizations from laser ranging to LAGEOS-1 and -2", EGS-AGU-EUG Joint Assembly, Abstracts from the meeting held in Nice, France, 6 - 11 April 2003.
- Pearlman, M., V. Husson, "The International Laser Ranging Service and Coordination of SLR Activities", *Proceedings of the International Seminar On the Use of Space Techniques for Asia-Pacific Regional Crustal Movements Studies*; pp 32 - 42 (Russian Academy of Sciences, Institute of Astronomy; Irkutsk, Russia; August 5 - 10, 2002) 32-42., 2003.
- Pierron, M., D. Feraudy, M. Furia, F. Pierron, "FTLRS laser staff, Laboratory Tests and Calibration on Chronometry for the French Transportable Laser Ranging Station", 14<sup>th</sup> International Laser Ranging Workshop, San Fernando, Spain, June 7-11, 2004.
- Prochazka, I., G. Kirchner, "Numerical Noise in Satellite Laser Ranging Data Processing", 14<sup>th</sup> International Laser Ranging Workshop, San Fernando, Spain, June 7-11, 2004.
- Prochazka, I., K. Hamal, L. Kral, "Atmospheric-fluctuation-induced laser ranging jitter", *Image and Signal Processing for Remote Sensing X*. Edited by Bruzzone, Lorenzo. *Proceedings of the SPIE*, Volume 5575, pp155-160, 2004.
- Prochazka, I., K. Hamal, "Laser Altimeter For Planetary Exploration", 14<sup>th</sup> International Laser Ranging Workshop, San Fernando, Spain, June 7-11, 2004.
- Prochazka, I., K. Hamal, "Recent Achievements in Detectors for Eye Safe Laser Ranging", 14<sup>th</sup> International Laser Ranging Workshop, San Fernando, Spain, June 7-11, 2004.
- Prochazka, I., K. Hamal, "Signal Strength Monitor for C-Spad Receiver", 14<sup>th</sup> International Laser Ranging Workshop, San Fernando, Spain, June 7-11, 2004.
- Quinn, K.J., J.O. Dickey, O. de Viron, S.L. Marcus, I. Fukumori, "Geocenter Variability and its Excitation: Insight From Geodetic and Global Geophysical Fluid Model Comparisons", AGU Fall Meeting Abstracts A2, 2003.
- Ravet, M., E. Samain, R. Dalla, P. Aubry, J.M. Torre, J. Paris, J.F. Mangin, G.M. Lagarde, "Time Transfer by Laser Link T212", 14<sup>th</sup> International Laser Ranging Workshop, San Fernando, Spain, June 7-11, 2004.

- Ray, J., G. Petit, Z. Altamimi, "Requirements for Improved Definitions and Realizations of the ITRF Origin and Geocenter Motion", AGU Fall Meeting Abstracts A1, 2003.
- Ricklefs, R., "Consolidated Laser Ranging Prediction Format: Field Tests", 14<sup>th</sup> International Laser Ranging Workshop, San Fernando, Spain, June 7-11, 2004.
- Ricklefs, R., "Consolidated Laser Ranging Prediction Format: Implications for Lunar Laser Ranging", 14<sup>th</sup> International Laser Ranging Workshop, San Fernando, Spain, June 7 - 11, 2004.
- Riepl, S., W. Schleuter, R. Dassing, K.-H. Haufe, N. Brandl, P. Lauber, A. Neidhardt, "The SOS-W - A Two Colour Kilohertz SLR System", 14<sup>th</sup> International Laser Ranging Workshop, San Fernando, Spain, June 7-11, 2004.
- Rim, H., S. Yoon, C.E. Webb, Y. Kim, B.E. Schutz, "ICESat Precision Orbit Determination", AGU Fall Meeting Abstracts A430, 2003.
- Rutkowska, M., "Satellite WESTPAC influence of the gravity field on the accuracy of orbit estimation", Artificial Satellites 38, 97-104, 2003.
- Salminsh, K., "Engineering Data File Processing and Distribution", 14<sup>th</sup> International Laser Ranging Workshop, San Fernando, Spain, June 7-11, 2004.
- Samain, E., G. Aridon, P. Exertier, J.F. Mangin, G.M. Lagarde, J.L. Oneto, J. Paris, F. Pierron, J.M. Torre, "MEO: The Future of the French Lunar Laser Ranging Station", 14<sup>th</sup> International Laser Ranging Workshop, San Fernando, Spain, June 11, 2004.
- Sarti, P., P. Sillard, L. Vittuari, "Surveying co-located space-geodetic instruments for ITRF computation", Journal of Geodesy 78, 210-222, 2004.
- Sawabe, M., T. Uchimura, A. Suzuki, H. Noda, "Laser Retroreflector Array of Geostationary Satellite, ETS-VIII", 14<sup>th</sup> International Laser Ranging Workshop, San Fernando, Spain, June 7-11, 2004.
- Sawabe, M., T. Uchimura, A. Suzuki, S. Murata, Y. Matsuoka, T. Oldham, J. Maloney, "Overview of GUTS SLR Station", 14<sup>th</sup> International Laser Ranging Workshop, San Fernando, Spain, June 7-11, 2004.
- Sawabe, M., T. Uchimura, S. Murata, Y. Matsuoka, T. Oldham, J. Maloney, "Remote Operation of GUTS-SLR", 14<sup>th</sup> International Laser Ranging Workshop, San Fernando, Spain, June 7-11, 2004.
- Schillak, S., "Analysis of the process of the determination of station coordinates by the satellite laser ranging based on results of the Borowiec SLR station in 1993.5-2000.5. Part 1: Performance of the satellite laser ranging", Artificial Satellites 39, 217-263, 2004.
- Schillak, S., "Analysis of the process of the determination of station coordinates by the satellite laser ranging based on results of the Borowiec SLR station in 1993.5-2000.5. Part 2: Determination of the station coordinates", Artificial Satellites 39, 265-287, 2004.
- Schillak, S., "Determination of the Station Coordinates for Quality Control of the Satellite Laser Ranging Data", 14<sup>th</sup> International Laser Ranging Workshop, San Fernando, Spain, June 7-11, 2004.
- Schillak, S., E. Wnuk, "The SLR stations coordinates determined from monthly arcs of LAGEOS-1 and LAGEOS-2 laser ranging in 1999-2001, Advances in Space Research 31, 1935-1940, 2003.
- Schreiber, U., H. Michaelis, J. Oberst, I. Leike, T. Spohn, "Technical Concept for a European Laser Altimeter for Planetary Exploration", 14<sup>th</sup> International Laser Ranging Workshop, San Fernando, Spain, June 7-11, 2004.
- Schutz, B.E., C. Webb, S. Bae, T. Urban, "Laser Pointing Determination for ICESat Altimetry", AGU Fall Meeting Abstracts 2, 2004.
- Schutz, B., "NASA ICESat Mission Status (Poster)", 14<sup>th</sup> International Laser Ranging Workshop, San Fernando, Spain, June 7-11, 2004.
- Selke, C., F. Koidl, G. Kirchner, L. Grunwaldt, "Tests of the Stability and Linearity of the A031et Event Timer at Graz Station", 14<sup>th</sup> International Laser Ranging Workshop, San Fernando, Spain, June 7-11, 2004.
- Shelus, P.J., R.L. Ricklefs, J.R. Wiant, J.G. Ries, "Lunar and Artificial Satellite Laser Ranging: The Use of Queue Scheduling and Worth Functions to Maximize Scientific Results", AAS/Division of Dynamical Astronomy Meeting 34, 2003.
- Shelus, P.J., B.E. Schutz, C.E. Webb, H. Rim, R.L. Ricklefs, S. Yoon, J.G. Ries, "SLR Observations of ICESat", AGU Fall Meeting Abstracts 80, 2004.
- Shuygina, N., "Determination of EOP from Combination of SLR and VLBI Data at the Observational Level", 14<sup>th</sup> International Laser Ranging Workshop, San Fernando, Spain, June 7-11, 2004.
- Smith, D., M. Zuber, "Precision Orbit Determination of Low Altitude Lunar Spacecraft with Laser Systems", 14<sup>th</sup> International Laser Ranging Workshop, San Fernando, Spain, June 7 - 11, 2004.
- Tangyong, G., T. Yechun, L. Cuixia, H. Shihua, L. Xin, W. Yinzhen, "The Performance and Observation of Mobile System TROS-1 In China", 14<sup>th</sup> International Laser Ranging Workshop, San Fernando, Spain, June 7-11, 2004.

- Torre, J.M., M. Furia, J.F. Mangin, E. Samain, "MEO Improvements for Lunokhod 1 Tracking", 14<sup>th</sup> International Laser Ranging Workshop, San Fernando, Spain, June 7 - 11, 2004.
- Torrence, M., V. Husson, "The ILRS Report Card and Performance Charts", 14<sup>th</sup> International Laser Ranging Workshop, San Fernando, Spain, June 7-11, 2004.
- Vigo-Aguir, I., J. Ferrandiz, J. Garate, J. Martin Davila, D. Garcia, "Determination of the Site Position at the SLR Tracking Station (7824) at San Fernando, Spain (Poster)", 14<sup>th</sup> International Laser Ranging Workshop, San Fernando, Spain, June 7 - 11, 2004.
- Wang, T., F. Qu, Z. Wei, N. Liu, B. Cheng, Q. Xiang, Y. Han, W. Liu, "Current Status of San Juan SLR Station in Argentina", 14<sup>th</sup> International Laser Ranging Workshop, San Fernando, Spain, June 7-11, 2004.
- Wilkinson, M., G. Appleby, "Return Energy Estimates Derived from Normal Point and Full-Rate Laser Data", 14<sup>th</sup> International Laser Ranging Workshop, San Fernando, Spain, June 7-11, 2004.
- Williams, J., D. Boggs, S. Turyshev, J.T. Ratcliff, "Lunar Laser Ranging Science", 14<sup>th</sup> International Laser Ranging Workshop, San Fernando, Spain, June 7 - 11, 2004.
- Wu, X., M.B. Heflin, E.R. Ivins, "Global Inverse Approach to ice Mass Variations Using Data Combination", AGU Spring Meeting Abstracts A1, 2004.
- Xiangming, Z., J. Chongguo, X. Yaoheng, Z. Yuncheng, L. Zhulian, W. Hanping, F. Honglin, "New Drive and Servo-Control System of Kunming SLR Station", 14<sup>th</sup> International Laser Ranging Workshop, San Fernando, Spain, June 7 - 11, 2004.
- Yang, F., Z. Zhang, W. Chen, J. Chen, "Satellite laser ranging observations at Shanghai Astronomical Observatory during 2001-2002", *Shanghai Observatory Annals* 24, 56-59, 2003.
- Yaoheng, X., G. Rui, "Real-Time Separation Atmospheric Tip-Tilt Signal from Lunar Surface", 14<sup>th</sup> International Laser Ranging Workshop, San Fernando, Spain, June 7-11, 2004.
- Zhao, Y., "Progress for Daylight Tracking in Changchun SLR System", 14<sup>th</sup> International Laser Ranging Workshop, San Fernando, Spain, June 7 - 11, 2004.
- Zheng, X., W. Wang, H. Feng, "Pointing model study of the 1.2m telescope - establishment of small period model of measuring angle coder", *Astronomical Research and Technology. Publications of National Astronomical Observatories of China* (ISSN 1672-7673), Vol. 1, No. 1, pp.64-68, 2004.
- Zhongping, Z, Y. Fumin, H. Jingfu, C. Wanzhen, C. Juping, L. Rendong, "Two-Wavelength Satellite Laser Ranging Experiment at Shanghai Observatory", 14<sup>th</sup> International Laser Ranging Workshop, San Fernando, Spain, June 7-11, 2004.
- Zhu, S., C. Reigber, R. Koenig, "Integrated adjustment of CHAMP, GRACE, and GPS data", *Journal of Geodesy* 78, 103-108, 2004.
- Zhu, Y., C. Feng, Y. Zhou, "Earth orientation parameters during 1990-2001 solved with LAGEOS-1 SLR data", *Shanghai Observatory Annals* 24, 28-33, 2003.
- Zuber, M., D. Smith, "Scientific Applications of Planetary Laser Altimeter Radiometry", 14<sup>th</sup> International Laser Ranging Workshop, San Fernando, Spain, June 7-11, 2004.

---

# APPENDIX A AC AND ACC REPORTS

FIELD PRACTICES



APPENDIX A







# APPENDIX A.

---

## ILRS ANALYSIS AND ASSOCIATE ANALYSIS CENTER REPORTS

### Astronomical Institute of the University of Bern (AIUB) Associate Analysis Center

*Urs Hugentobler, Claudia Urschl/Astronomical Institute, University of Bern, Switzerland*

The Center for Orbit Determination in Europe (CODE) is located at the Astronomical Institute of the University of Bern and is a joint venture of the Swiss Federal Office of Topography (Swisstopo), Wabern, the “Bundesamt für Kartographie und Geodäsie” (BKG) in Frankfurt, Germany, the “Institut Géographique National” (IGN) in Paris, France, and the Astronomical Institute of the University of Bern (AIUB). CODE is one of the eight analysis centers of the International GPS Service (IGS) since the start of the IGS in June 1992. Some of the products generated on the basis of tracking data from the IGS global network are precise orbits for the GPS and GLONASS satellites for the IGS final, rapid, and ultra rapid (made available four times per day) as well as orbit predictions. GLONASS observations have been processed since May 2003 in a fully combined GPS/GLONASS data analysis.

As an associate analysis center of the International Laser Ranging Service, CODE has provided an SLR-GPS quick-look service since December 1996. Since April 2004 quick-look reports have included GLONASS results. The reports are based on the residuals of the SLR observations taken from the two GPS satellites PRN 5 and PRN 6 and of the three GLONASS satellites PRN 03, PRN 22, and PRN 24 tracked by the ILRS with respect to the CODE IGS final and rapid orbits as computed from microwave observations. Each day the SLR observations gathered over the previous six days and downloaded from CDDIS are evaluated. The last four days’ data are analyzed using the rapid orbits and the two older days’ data using the final orbits. The SLR-GNSS quick-look results, covering six days, are distributed by e-mail to the SLReport mail exploder every day – provided that new data was available – giving rapid feedback on the quality of the SLR observations. Since day 016 of year 2002, the quick-look residuals are referred to ITRF2000.

In April 2004 the procedure for generating the quick-look reports was revised. Since then, the reports contain GLONASS residuals, observations from all SLR stations tracking GNSS satellites available at CDDIS, and two-wavelength SLR data that have been analyzed and reported. The offsets used for SLR satellite reflectors are given in the following table.

**Table A-1. SLR Satellite Reflector Offsets for GNSS Satellites**

Satellites	X	Y	Z	
GPS	0.8626	-0.5245	0.6584	m
GLONASS	0.0000	0.0000	1.5416	m

CODE also provides daily orbit predictions for all GPS and GLONASS satellites spanning a time interval of five days. For both satellite systems the predictions consist of an extrapolation of the CODE rapid orbits, which are based on microwave observations spanning three days. These predictions are usually available at noon of the day after the last

observations used. They are converted from the standard IGS orbit format (SP3) to IRVs by the National Environment Research Council (NERC) and used by several of the (European) SLR tracking stations.

SLR validation of the final orbits computed for IGS at CODE shows a standard deviation of about 2.7 cm for GPS orbits and about 5 cm for GLONASS orbits. For GPS a mean offset between SLR observations and microwave-derived orbits of  $-5.5$  cm to  $-6$  cm is observed while the offset for GLONASS is about  $-2$  to  $-2.5$  cm. This offset agrees well with values found in several previous studies, but its origin is still unknown.

The AIUB continues to use SLR observations for the validation of precise orbits computed for low Earth orbiting satellites equipped with GPS receivers such as CHAMP, GRACE and Jason. Eventually GNSS and SLR observations will be combined.

## **References**

Urschl, C., W. Gurtner, U. Hugentobler, S. Schaer, G. Beutler (2004): "Validation of GNSS orbits using SLR observations", 35th COSPAR Scientific Assembly, Paris, France, July 18-25, 2004. Submitted to Adv. Space Res.

## **Contact**

Urs Hugentobler  
Astronomical Institute of Berne  
Sidlerstrasse 5  
CH-3012 Berne  
SWITZERLAND

E-mail: [urs.hugentobler@aiub.unibe.ch](mailto:urs.hugentobler@aiub.unibe.ch)

## Italian Space Agency/Space Geodesy Center “G. Colombo” (ASI/CGS) Associate Analysis Center

*Vincenza Luceri (1), Cecilia Sciarretta (1), Giuseppe Bianco (2), Roberto Devoti (1)/*

*(1) Telespazio S.p.A., Centro di Geodesia Spaziale*

*(2) Agenzia Spaziale Italiana, Centro di Geodesia Spaziale*

### Introduction

ASI Space Geodesy Center “G. Colombo” (CGS) located in Matera, Italy, is a fundamental geodetic observatory, hosting three permanent Space Geodetic systems (SLR since 1983, VLBI since 1990, GPS since 1995). Due to the multi-technique nature of the CGS mission, geodetic technique combination methods and applications are a top priority objective of the data analysis activities performed at the center. In the 2003-2004 period the usual classic geodetic products (i.e., global SLR network coordinate/velocities, EOP time series, etc.) provided by the CGS, have been complemented with studies and products related to the solution combination, conforming to the ILRS and IERS directions. Information on the CGS and some of the analysis results are available at the CGS WWW server GeoDAF (Geodetical Data Archive Facility, <http://geodaf.mt.asi.it>).

### Current Activities

In the past two years, ASI/CGS has enhanced its capability to produce global, extended solutions in support of reference frame maintenance. Particular efforts have been devoted to the gravity field related products (geocenter motion, low degree zonals time variation) and to the exploitation of the unique sensitivity of the SLR technique to global parameters, such as the origin and scale of the Terrestrial Reference Frame, and of the remarkable length of the SLR dataset, allowing the stable and accurate retrieval of those parameters at different time scales.

The main application fields are listed hereafter.

- International Terrestrial Reference System (ITRS) maintenance: the production of IERS oriented products (global SSC/SSV and EOP time series) is regularly performed, both as an annual call response and as a contribution to the operational EOP series (Bulletin B and EOP C 04 update) to assure the CGS contribution to the reference frames establishment.
- ILRS AWG “Pos+EOP Pilot Project”: regular submission of coordinate/EOP solutions following the pilot projects requirements and of combined solutions. In 2004 ASI/CGS was selected as the primary official combination center for two years by the ILRS;
- ILRS AWG “Benchmarking” Pilot Project: participation in the project for comparison of the different analysis software packages;
- ILRS Refraction Study Group: participation in the activities to test new tropospheric models;
- Geodetic solution combination: realization, implementation and testing of combination algorithms for the optimal merging of global inter- and intra-technique solutions and of regional (e.g., Mediterranean) solutions to densify tectonic information in crucial areas; these activities are framed within the ILRS AWG and IERS CRC contexts;
- Gravity field investigations: the long extended global solutions produced are used to derive low degree geopotential parameter estimations, inferring information about geocenter motion and low degree zonals drift; methodology and analysis strategy information derived in the past two years will be conveyed in a revised two-decadal multi-satellite global solution to be issued at the beginning of 2005.

## Data Products Provided

- CGS03L01 global solution, from LAGEOS-1 and -2 data (1985-2002), submitted to the IERS annual call (2003). Global network SSC/SSV, daily EOP (x, y, LOD), J2 are the main parameters estimated in this solution.
- ASI04L01 global solution, from LAGEOS-1 and -2 data (1985-2003), submitted to the IERS annual call (2004). Global network SSC/SSV, daily EOP (x, y, LOD), geocenter (C10, S11, C11) are the main parameters estimated in this solution.
- Ten-year series (1993-2003) of weekly solutions (SSC, EOP) from LAGEOS-1 and -2 data, submitted to IERS in support of the next ITRF definition strategy (ITRF SINEX Combination Campaign);
- One-day estimated EOP, from LAGEOS-1 and -2 data (plus Etalon-1 and -2 from 2004), routinely provided to IERS for the upgrade of monthly Bulletin B and EOP C 04;
- Multi-satellite, long-extended (1986-2002) global solution from LAGEOS-1 and -2, Stella, and Starlette data dedicated to the gravity field low degree zonals estimation (J2, J4, J6 and Jodd);
- Twenty-year long (1984-2003) global solution from LAGEOS-1 and -2 data and a time series of fortnightly/weekly solutions from LAGEOS-1 and -2 covering the same twenty-year period, both dedicated to the geocenter estimation;
- Regular weekly submission of SSC and EOP solutions, estimated using LAGEOS-1 and -2 and Etalon-1 and -2 data, for the ILRS AWG Pos+EOP Pilot Project
- Regular weekly submission of SSC and EOP combined solutions, combined from the contributing solutions estimated by different analysis centers, for the ILRS AWG Pos+EOP Pilot Project;
- Five monthly global solutions for the ILRS AWG Benchmarking Pilot Project;
- Three different monthly solutions time series (1999-2001) from LAGEOS-2 data using different tropospheric refraction models for the ILRS Refraction study Group;
- ASI-Med two year solutions, with the estimation of tectonic movements and strain-rates in the Mediterranean area combining SLR, GPS and VLBI results obtained at CGS

## Future Plans

Most of the current activities will continue, with particular attention to the ILRS and IERS oriented products. Deeper investigations will be directed to the analysis of the geocenter time series and to the new time series of low degree geopotential zonals that is now under construction. New application fields for the near future include:

- Satellite rotation: further investigations on LAGEOS rotation with the use of the MLRO streak camera and new analysis methods on the ranging data.
- LLR data analysis activities will soon start together with the MLRO routine lunar tracking.

## Contacts

Dr. Giuseppe Bianco  
Agenzia Spaziale Italiana (ASI)  
Centro Geodesia Spaziale  
PO Box 11, 75100 Matera (MT)  
ITALY

Voice: 39-0835-377209  
Fax: 39-0835-339005  
E-mail: giuseppe.bianco@asi.it

Dr. Vincenza Luceri  
Telespazio S.p.A.  
Centro di Geodesia Spaziale  
P.O. Box 155, 75100 Matera  
ITALY

Voice: 39-835-377231  
Fax: 39-835-334951  
E-mail: cinzia.luceri@asi.it

## **Bundesamt für Kartographie und Geodäsie (BKG) Associate Analysis Center**

*Maria Mareyen, Bernd Richter/BKG*

The ILRS AAC at BKG has finished the adaptation of all UTOPIA subroutines and scripts to the Linux operating system and a new compiler version. To meet the requirements of the ILRS weekly solutions w.r.t. precision and parameters, a model update was installed in the UTOPIA software at BKG (geopotential, solid tide, local site displacement due to ocean loading, tropospheric model, and EOP variations due to ocean tides). Another augmentation to the UTOPIA capabilities was aimed to allow processing of normal points of laser observations in a two-wavelength-mode. All these updates were supported by CSR. The multi-wavelength analysis will be applied to the two-wavelength ranging at the Conception SLR station (TIGO) as an additional feedback to check the performance of the laser hardware.

The UTOPIA version at BKG does not estimate LOD and station velocities, nor can multi-satellite combined solution be archived. The BKG ILRS AAC has developed new software to determine the time derivative LOD and station velocity. For several satellites the individual UTOPIA results are combined at the observation level and the required parameters are derived. For delivery, a software package has been developed to transform the combined solution into SINEX format. The entire process, from downloading the normal points to performing the weekly analysis, is organized in an automatic batch mode that includes quality checks. A benchmark solution was transmitted in October 2004. Having passed the test, BKG is prepared to analyze and submit weekly ILRS solution series to the “Computation of station positions and EOPs” project.

### **Contact**

Dr. Bernd Richter  
BKG  
Richard Strauss-Allee 11  
D-60598 Frankfurt/Main 70  
GERMANY

Voice: 49-69-6333273  
Fax: 49-69-6333425  
E-mail: richter@iers.org

## Center for Space Research (CSR), University of Texas Analysis Center

*Richard Eanes, John Ries, Minkang Cheng/CSR*

### **Current Activities**

#### ***Automation of EOP estimation and SLR Network Quality Control***

With the successful implementation by the ILRS network of an hourly distribution cycle for ILRS range normal points, we have automated the SLR analysis at CSR for LAGEOS-1/2. The automation is accomplished via sequences of Unix shell scripts activated using the Unix cron utility. We download the most recent two days of hourly ILRS NP files from both the CDDIS and GFZ data centers. The hourly files are then supplemented with the daily files created at both ILRS data centers in order to minimize the chance of missing any data. When the update of our normal point archive is completed, the main analysis script begins the required computations at six-hour intervals.

#### ***Precision Orbit Determination and Verification***

SLR and DORIS tracking provide the principal means of precise orbit determination for the TOPEX/Poseidon and Envisat altimeter spacecraft. Studies have demonstrated that the SLR data contribute critically to the accuracy of the centering of the altimeter orbits with respect to the Earth's mass center, particularly along the Z-axis (along the Earth's spin axis). Correct centering is important to avoid artificial signals in the observed sea surface variations between the hemispheres that might be erroneously interpreted. The SLR data, due to the absolute ranging information that they provide, help to center the orbit more precisely and consistently, as well as contribute to the overall orbit accuracy.

SLR also provide an unambiguous determination of the height of the spacecraft above a tracking station, particularly for passes that cross at a high elevation angle. This capability is unique to SLR, and it is crucial for orbit accuracy assessment at the current levels. It has been demonstrated, for example, that GPS can support orbit accuracy at the 1-cm level for Jason-1 (Choi et al., 2004). The SLR data, when withheld from the orbit fits, are critical for verifying that this level of orbit accuracy is actually being achieved. Similarly, the SLR tracking has verified that 2-3 cm orbits are being achieved for ICESat (at 600 km altitude) and the GRACE satellites (at 470 km). The SLR data are critical for validating and monitoring the tracking data processing for these missions. The SLR tracking to other 'cannonball' satellites has also been invaluable in testing the accuracy of the GRACE gravity models.

#### ***Terrestrial Reference Frame***

We have continued to monitor the variations in the geocenter location, since this represents both possible systematic drifts in the terrestrial frame as well as seasonal mass transport within the Earth system that is not well monitored by other techniques. The GRACE mission, for example, is able only to monitor the temporal mass changes for degrees 2 and above. The geocenter variations (equivalent to the degree-1 geopotential harmonics) contain an important mass variation signal. In Figure A-1, we show a new estimate of the geocenter motion obtained from SLR tracking to LAGEOS-1/2 since the beginning of the LAGEOS-2 mission in 1992. In this analysis, the network is held fixed to ITRF2000, and the geocenter offset is estimated every 30 days. We have previously noted a significant drift relative to ITRF2000 in Z, but this analysis indicates a drift in X and Y as well. This may be a consequence of the relatively simple method used to determine the geocenter time series. The annual variations determined from this series agree well with a number of other SLR-based estimates in amplitude and phase.

### **Seasonal and Long-period Variations of the Earth's Gravity Field**

We have obtained a new determination of the long-term variations in  $J_2$ , shown in Figure A-2, by analysis of the SLR data from multiple geodetic satellites over the past 28 years (Cheng and Tapley, 2004). In addition to the secular change of  $-2.75 \times 10^{-11}/\text{year}$  induced primarily by post-glacial rebound and the annual variations, successive 4-6 year and a variation with a time scale of  $\sim 21$  year are observed in the post-1976  $J_2$  variations. In particular, two large fluctuations in  $J_2$  are correlated with the strong ENSO events of 1986-1991 and 1996-2002. Contemporary models of the Earth's mass redistributions can account for a major part of the observed 4-6 year variations during the strong ENSO events. The apparent 1998 'anomaly' is due to the superposition of the 5.8-year variation with a decadal variation. An improved model of the 18.6-year anelasticity effect is required for understanding the nature of the variations with time scale of  $\sim 21$  years. The cause of the decadal variations remains unknown.

A similar analysis of the most recent SLR data has been used to evaluate the low degree harmonics determined from the GRACE mission, currently in Validation Phase (Ries et al., 2004). It was clear that the C20 harmonic from GRACE was sometimes not well determined, but the agreement between SLR and GRACE for other low-degree harmonics is quite good. In Figure A-3, for example, we see that the GRACE estimates for the C22 and S22 harmonics are in very good agreement. The seasonal variation is clearly determined by both GRACE and SLR. There is little seasonal variation seen in C22, but the agreement is good.

### **Analysis Working Group Members**

Richard Eanes, Minkang Cheng, John Ries, Bob Schutz

### **References**

- Cheng, M., and B. Tapley, Variations in the Earth's oblateness during the past 28 years, *J. Geophys. Res.* (109), B09402, doi:10.1029/2004JB003028, 2004.
- Choi, K., J. Ries, and B. Tapley, JASON-1 precision orbit determination by combining SLR and DORIS with GPS tracking data, *Marine Geodesy*, 27(1-2), 319-331, 2004.
- Ries, J., et al., Assessment of low degree harmonics in GRACE monthly solutions, Joint CHAMP/GRACE Science Meeting, Potsdam, Germany, July 5-8, 2004 (proceedings in preparation).
- Tapley, B., S. Bettadpur, J. Ries, P. Thompson, and M. Watkins, GRACE Measurements of Mass Variability in the Earth System, *Science*, July 23, 2004.

### **Contact**

Richard Eanes  
University of Texas, Center for Space Research  
3925 West Braker Lane, Suite 200  
Austin, TX 78759-5321  
USA

Voice: 512-471-7560  
Fax: 512-471-3570  
E-mail: eanes@csr.utexas.edu

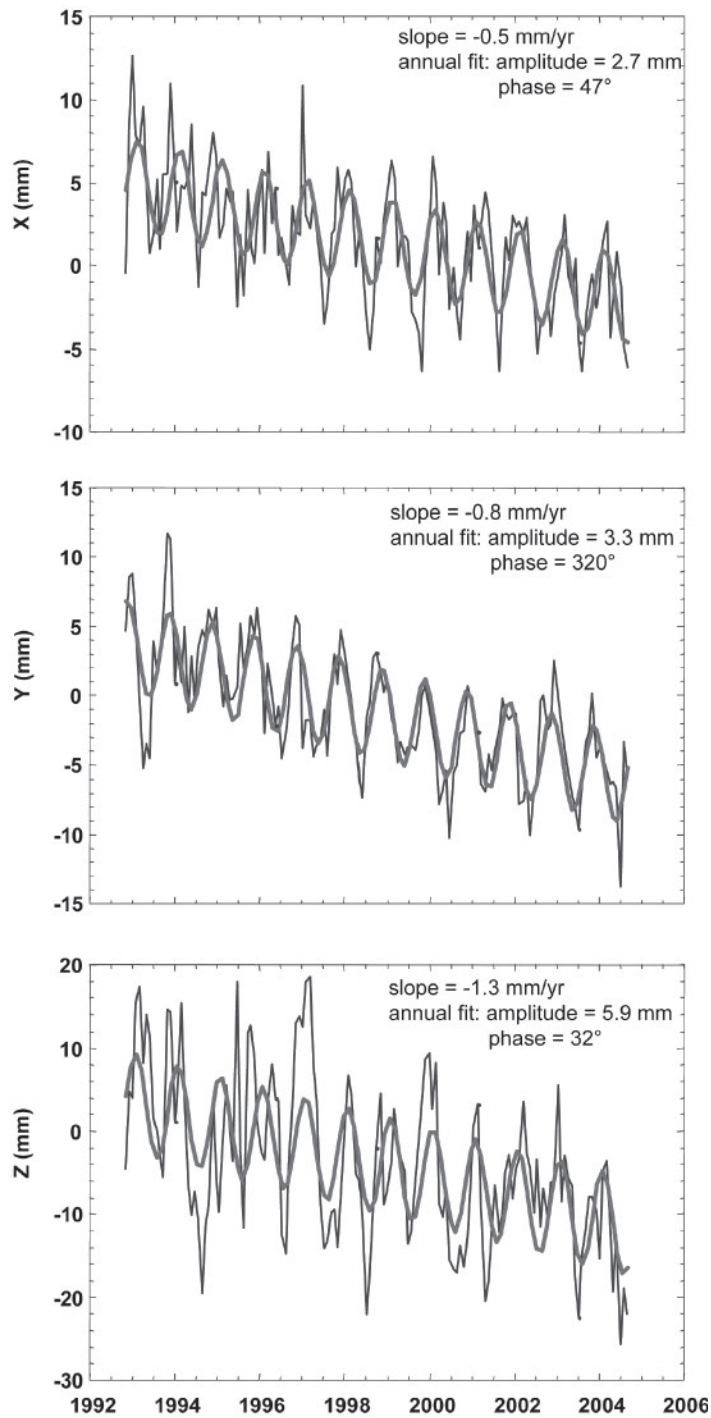

Figure A-1. Geocenter variations estimated from LAGEOS-1 and LAGEOS-2.



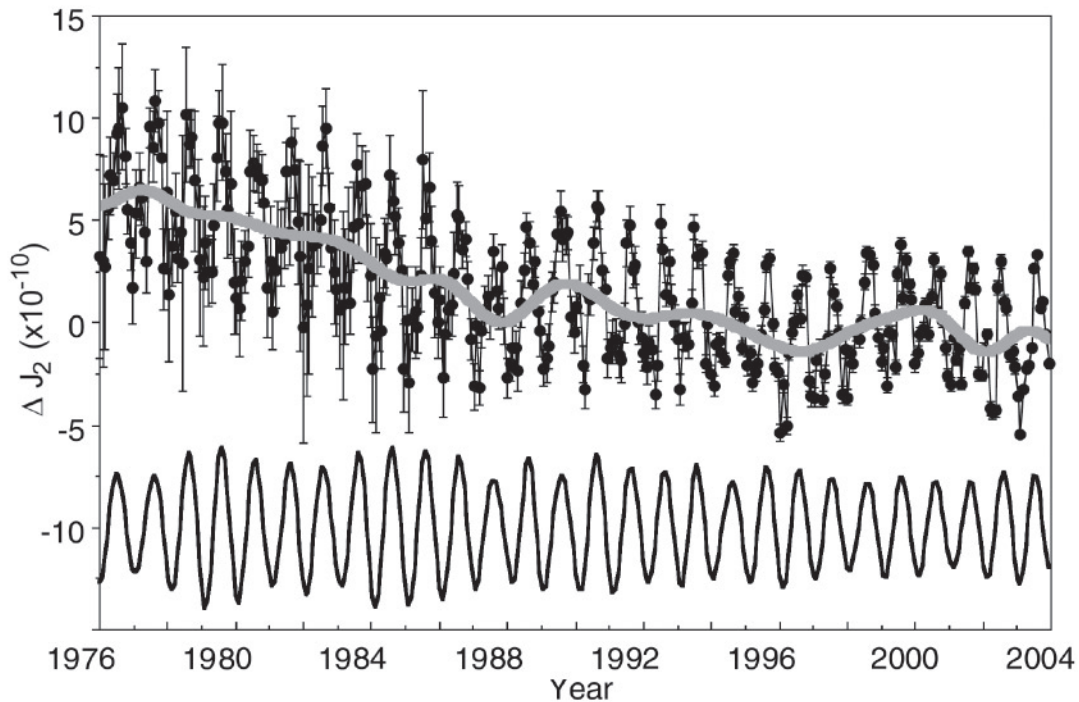

Fig. 1

Figure A-2. Variation in  $J_2$  from SLR data with 30-day sampling interval (dotted black line) and its long wavelength signature (gray line). The seasonal variation (solid black line, biased by  $-1.5 \times 10^{-10}$ ) is separated from original time series by wavelet analysis.

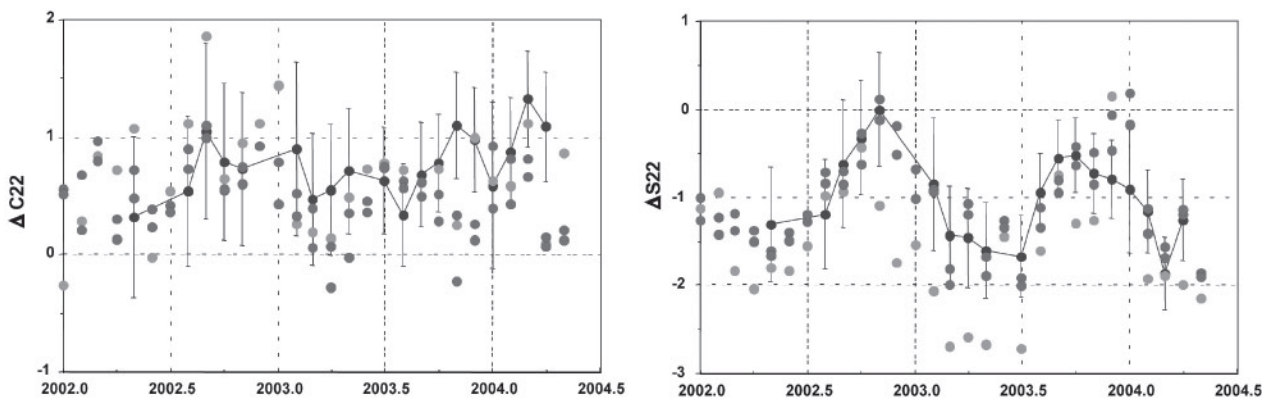

Figure A-3. Comparison of  $C22$  and  $S22$  geopotential harmonics determined by GRACE and with SLR tracking to multiple geodetic satellites. The mean value has been removed and the units are  $10^{-10}$ ; harmonics are normalized. The connected points (blue) are the monthly GRACE estimates with approximate error bars. The other points are SLR determined estimates using only LAGEOS-1/2 (cyan), 5 SLR satellites estimating a  $3 \times 3$  degree and order field (green), and 5 SLR satellites estimating a  $4 \times 4$  field (red). The scatter of the SLR estimates provides some estimate of the uncertainty of the SLR analysis.

## **Center for Space Research (CSR), University of Texas Lunar Analysis Center**

*Peter Shelus/CSR*

An ILRS LLR analysis center exists at the University of Texas at Austin Center for Space Research and the McDonald Observatory. The small size of the LLR observing network dictates the unique nature and operational procedures of this LLR analysis center. Predictions are performed on-site at each station and data are automatically transferred from all observing sites to the data centers. Analysts secure their data directly from the data centers as needed. Feedback from the analysts often goes directly to the observing stations. The responsibility of the LLR analysis center has evolved to be one that assures the smooth flow of data, in a form and format that is useful for obtaining scientific results. The center also coordinates the observations and their scheduling in a manner to maximize the scientific gains. In spite of severe financial difficulties, some progress has been accomplished in the LLR experiment within the UT LLR analysis center. We are looking forward to another year of successful activity.

### **Contact**

Dr. Peter Shelus  
University of Texas, Center for Space Research  
3925 West Braker Lane, Suite 200  
Austin, TX 78759-5321  
USA

Voice: 512-471-7599  
Fax: 512-471-3570  
E-mail: [shelus@csr.utexas.edu](mailto:shelus@csr.utexas.edu)

---

## Deutsches Geodaetisches Forschungsinstitut (DGFI), Germany

### Associate Analysis Center

*Horst Mueller, Rainer Kelm, Detlef Angermann/DGFI*

#### Introduction

Since the beginning of the activities of the ILRS Analysis Working Group (AWG) DGFI has participated in the pilot projects. During the ILRS AWG Meeting on April 22-23, 2004, in Nice, France, DGFI was nominated as one of the five official ILRS analysis centers and on the next meeting in San Fernando, Spain on June 5, 2004, as official backup ILRS Combination Center. In addition to these tasks, DGFI is reprocessing all SLR LAGEOS tracking data starting from 1981.

#### ILRS Analysis Center

As an ILRS analysis center, DGFI processes SLR data on LAGEOS-1/2 and Etalon-1/2 on a weekly operational basis and provides loose constrained solutions (SINEX files) with station positions and Earth orientation parameters (x-pole, y-pole and length of day) to the data centers at CDDIS and EDC. The processing is performed with the DGFI software package DOGS.

During the automatic processing a number of quality checks are performed, including a computation of pass-wise range and time biases. The weekly solutions and the results of the bias analysis, sorted by satellite and week, are available from the DGFI web server, <http://ilrsac.dgfi.badw.de>. We provide the biases with respect to ITRF2000 coordinates for all station and passes. The directories contain two series of biases, one where we solve for range and time biases simultaneously and one where we solve for range biases only.

#### ILRS Combination Center

DGFI, as the official ILRS Backup Combination Center, uses the same procedures and constraints as the ILRS Primary Combination Center, ASI, Italy. Both centers are obliged each week to compute a combined SLR solution as the official product of the ILRS. The products are stored at the data centers of CDDIS and EDC. Both combination centers have software for automated processing.

The official weekly products are:

- Combined solution for station coordinates and EOP. DGFI delivers a SINEX file with a minimal constraints solution and with an unconstrained normal equation system.
- Combined solution for EOP aligned to ITRF2000. DGFI takes the EOP part of the above combined solution arguing that the minimal constraints solution is indirectly an alignment to ITRF2000, because the a priori coordinate values are taken from ITRF2000.

#### Reprocessing of SLR Data

DGFI has started to reprocess all SLR tracking data, starting in January 1981 for LAGEOS-1 and since October 1992 for LAGEOS-2, with the latest version of the DOGS software and consistent modelling. The computations are an iterative procedure based on weekly single satellite arcs starting with ITRF2000 station coordinates (for the newer SLR tracking we used the results of DGFI solutions) and IERS EOPC04 Earth orientation parameters. In a first step we checked for outliers and pass biases on arc basis. In the second step we analyzed the weekly arcs looking for discontinuities in the time series of the weekly station positions, which could be produced by earthquakes, instrumental or unknown

station problems. The edited arcs were used to compute a series of  $J_2$  values (see Figure A-4), and to generate weekly unconstrained normal equations for both satellites. In the near future we will provide two solutions, one accumulated SLR only solution and one combined solution including GPS, VLBI and DORIS data.

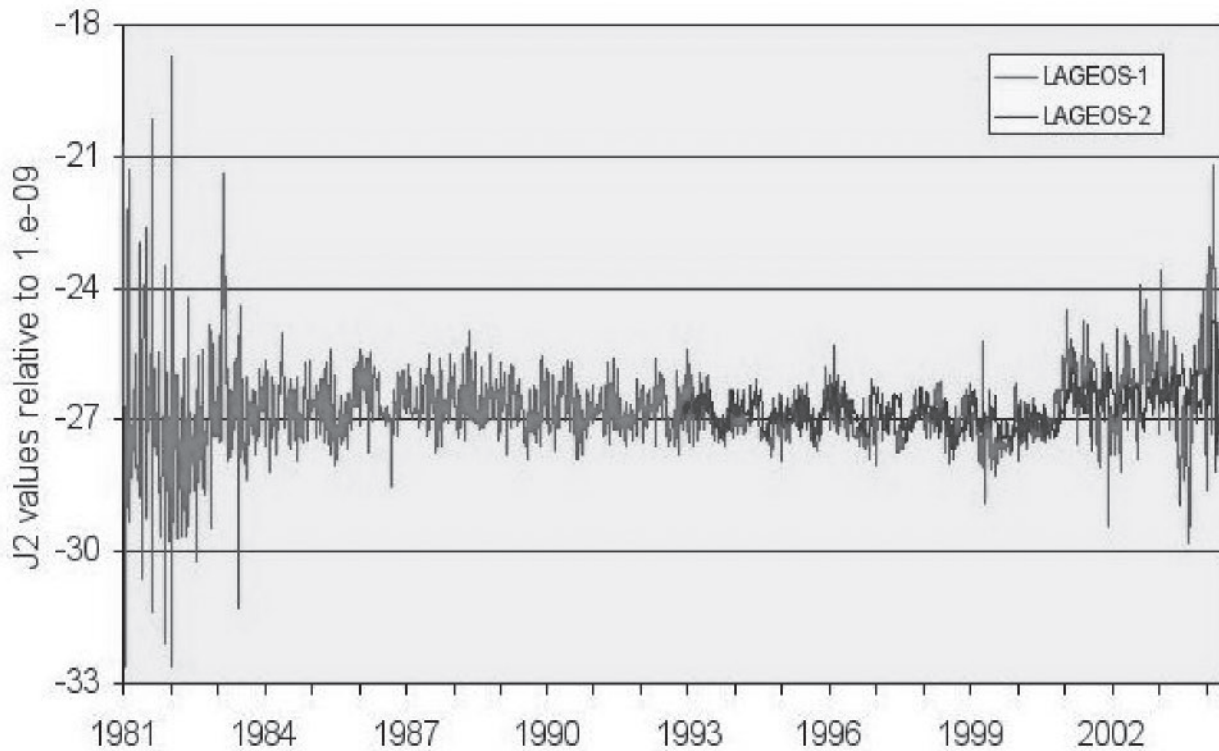

Figure A-4.  $J_2$  series of LAGEOS-1 and -2 data for 1981-1992.

## References

- Angermann, D., D. Thaller, M. Rothacher: IERS SINEX combination campaign. Proceedings of IERS workshop on combination research and global geophysical fluids. IERS Technical Note 30, 94-101, 2003.
- Angermann, D., B. Meisel, M. Krügel, H. Müller, V. Tesmer: Time series of site positions and datum parameters. Proceedings of IERS workshop on combination research and global geophysical fluids. IERS Technical Note 30, 199-201, Verlag des Bundesamtes für Kartographie und Geodäsie, Frankfurt a.M., 2003.

## Contact

Horst Mueller  
DGFI  
Marstallplatz 8  
D-80539 Munchen  
GERMANY

Voice: 49-89-23031277  
Fax: 49-89-23031-240  
E-mail: horst.mueller@dgfi.badw.de

---

# Delft University of Technology (DUT) Analysis Center

*Nacho Andrés de la Fuente, Eelco Doornbos, Ron Noomen/DUT*

## Introduction

The Department of Earth Observation and Space Systems (DEOS) at Delft University of Technology (DUT) has been active in the field of SLR analysis since about 1980. The current activities include (1) LAGEOS quick-look analysis, (2) LAGEOS crustal dynamics investigations, and (3) ERS-2 and Envisat orbit computations.

## LAGEOS Quick-look Analysis

The Quick-Look Data Analysis Center (QLDAC) has been operational at DUT/DEOS since the beginning of 1986. The main objectives are a semi real-time quality control (QC) of the global SLR observations on LAGEOS-1 and LAGEOS-2, and the production of Earth Orientation Parameters (EOPs), for inclusion in the IERS Bulletins A.

Being an operational analysis service, the QLDAC analysis system run all through the reporting period. Major developments of the analysis system took place, in particular in the fields of computation model and analysis strategy. As for the former, the outdated model for station coordinates SSC(DUT)93L05 was replaced by ITRF2000. In addition, a linear regression model for the representation of atmospheric pressure loading station displacement was developed and implemented. Third, the frequency of solving for the empirical accelerations experienced by the LAGEOS satellites was increased to two times per 8-day period (originally, this was once). Fourth, provisions for processing data taken by multiple-wavelength laser systems were added. Finally, the estimation of the 3-dimensional position of the geocenter was included in the analysis. On an organizational level, a second series of QC analyses was initiated in the beginning of 2004, running on a daily schedule, rather than the (standard) weekly schedule. This alternative configuration is expected to become really operational in the fall of 2004. The modifications have led to a remarkable improvement in quality of the solutions (orbit, EOPs, biases): the global weighted rms-of-fit has decreased from 5-30 mm to about 10-14 mm, which is a major improvement for a QC service. In combination with the daily analysis frequency, the network of SLR stations is clearly better served with the new configuration.

As for the (near) future, QLDAC intends to introduce several new elements in the operational analysis: (1) the use of internet to disseminate analysis results, (2) the addition of other satellites, probably the Etalons, (3) the implementation of new models to represent the effect of refraction, and (4) the modeling of the station-satellite characteristics.

## Crustal Dynamics

The SLR observations on LAGEOS-1/2 are also used for crustal dynamics investigations. Here, it is extremely important to model the orbit of the LAGEOS spacecraft as well as possible. An element of the dynamic model for these vehicles, which has gained significance during the last few years, is the thermal forces (the pressure force exerted by the photons emitted by the hot components of the satellite surface). Since the rotation of LAGEOS-1 has almost stopped, these forces do no longer average out, and the result can easily deteriorate the quality of orbit solutions. DEOS has developed the preliminary LAGEOS Spin Axis Model (LOSSAM-1), which is based on (a development of) the theory on rotational dynamics available in the literature and on independent observations of the spin axis orientation and the spin rate coming from various data sources. Following up on this, models to represent the instantaneous thermal force exerted by the satellites and forces induced by the interaction with the electromagnetic environment, are in development: in particular, a theoretical approach combined with Finite Element Methods is used to model such forces. The ultimate goal is to derive a highly accurate time-series of solutions for the low-degree terms of the Earth's gravity field.

## ERS-2 and Envisat Precise Orbit Determination

DEOS has continued its analysis of orbits and altimetry of the European remote sensing satellites ERS-2 and Envisat. In the routine orbit determination for ERS-2, SLR measurements have been combined with altimeter heights and crossovers.

Unfortunately, ERS-2 suffered a failure of its last available tape recorder in June 2003. Since that time, altimeter measurements are only available over parts of the North Atlantic, within sight of receiving stations in Europe and North America. The near real-time orbit determination for ERS has since been stopped. The precise orbit determination is now continued using SLR data only, in support of SAR interferometry studies. For Envisat, the SLR data are used in combination with DORIS tracking measurements.

With the decrease in solar activity during 2003 and 2004, we have seen an increase in the consistency and accuracy of the computed orbits. The adoption of the EIGEN-GRACE01S gravity model, instead of the ERS-tuned DGM-E04 model, has also led to a significant improvement in orbit accuracy. The radial orbit accuracy is currently estimated at 2.5 to 3 cm for Envisat and 4 cm for ERS-2. Preparations are currently underway for precise orbit determination of Cryosat, to be launched during the first half of 2005.

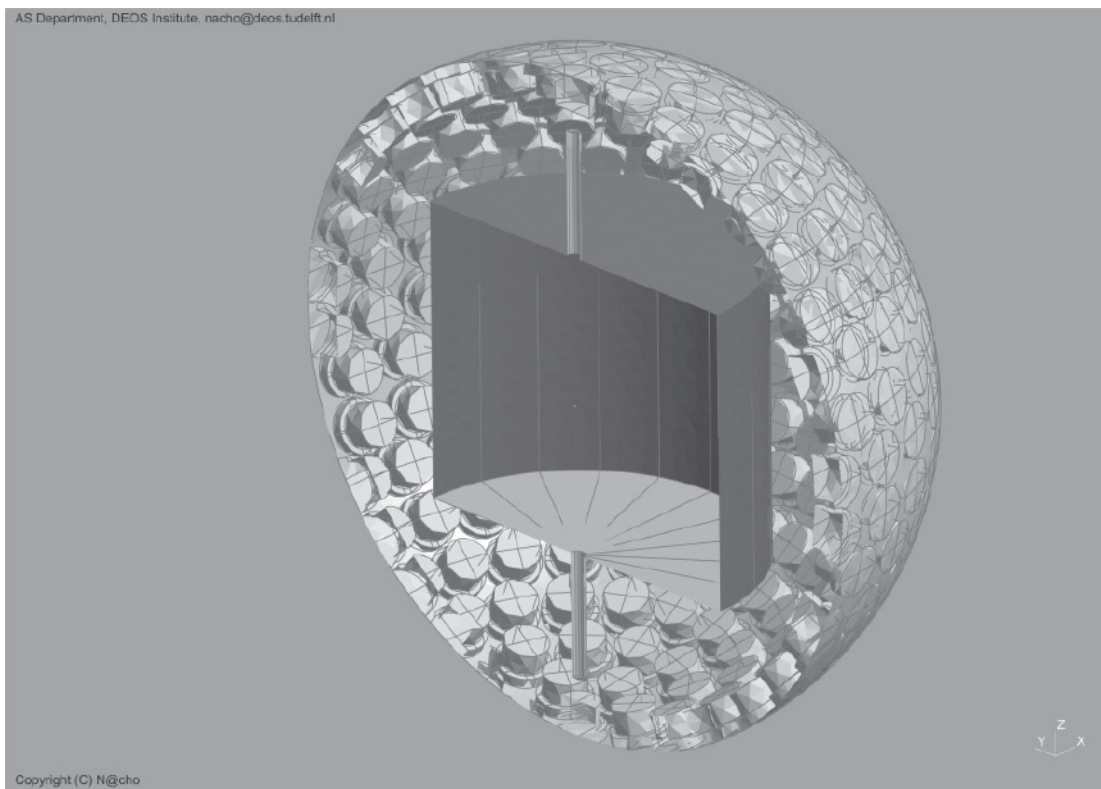

*Figure A-5. LAGEOS 3D model used in the Finite Element Method computations. The elements comprising the satellite (e.g., CCRs, internal cylinders and aluminum hemispheres) together with differentiated light conditions (illuminated and dark hemispheres, tilted upper and lower hemispheres respectively) are shown in this figure.*

## Contact

Ron Noomen  
Delft University of Technology  
Faculty of Aerospace Engineering  
Kluyverweg 1  
2629 HS Delft  
THE NETHERLANDS

Voice: 31-15-2785377  
Fax: 31-15-2783444  
E-mail: ron.noomen@deos.tudelft.nl

# European Space Operation Centre (ESOC) Associate Analysis Center

*Michiel Otten, John Dow, Rene Zandbergen, Dirk Kuijper/ESA ESOC*

## Introduction

One of the tasks of the Navigation Support Office of the European Space Operation Centre (ESOC) is to provide high-precision restituted orbit data for ESA's Earth Observation missions (ERS, Envisat), which are used, among others, to assist in the calibration and validation of the altimeter instruments and data processing techniques. To achieve this, SLR data for ERS-2 and Envisat are processed on a daily basis, together with other instrument data for the two missions.

In addition to this, ESOC Flight Dynamics is responsible for the delivery of predictions for Envisat, which are disseminated to all SLR stations using the standard ILRS prediction format and exchange mechanism. This activity includes predictions over orbit maintenance maneuvers, which are also planned and executed at ESOC. This system has been upgraded since ESOC became the prime prediction center after the discontinuation of these activities in HTSI.

## Facilities/Systems

All orbit solutions and related products are generated using a common software package (NAPEOS) and are generated automatically using a batch least-squares process. The orbit solutions consist of 5-day arcs with varying timeliness of availability, depending on the mission. For ERS-2 the solution is generated with a delay of one week to allow collection of all SLR tracking data. For Envisat the fast-delivery solution is generated after 36 hours while the final precise orbit solution has a typical delay of 6-9 weeks depending on when the DORIS Doppler data become available.

For each solution, reports are made available on our Web site (<http://nng.esoc.esa.de>) and comparisons of the solutions are made against the routine orbit solution (ERS-2 and Envisat) and the CNES Medium and Precise orbit ephemerides (MOE and POE) for Envisat.

## Current Activities

For ERS-2, until August 2003 the SLR data were used together with the fast-delivery altimeter data in the orbit determination process. This task also included the computation of monthly sea level anomaly solutions from the ERS-2 altimeter data. Since August 2003, the available amount of fast-delivery altimeter data has been drastically reduced due to the failure of the last tape-recorder onboard ERS-2, and the SLR data have become the sole means to generate routinely precise solutions for ERS-2.

For Envisat, two different precise orbit solutions are generated. The first solution is a fast-delivery solution, which uses the SLR data together with the fast-delivery altimetry data. This solution is used to support the operational activities of Envisat and is also used to monitor the long-term performance of the Envisat altimeter. The second (and final) precise solution for Envisat is generated when the DORIS Doppler data for Envisat become available and is used to monitor the SLR and DORIS Doppler data performance.

Figure A-6 shows the RMS of fit and the number of SLR normal points from the final Envisat orbit solution.

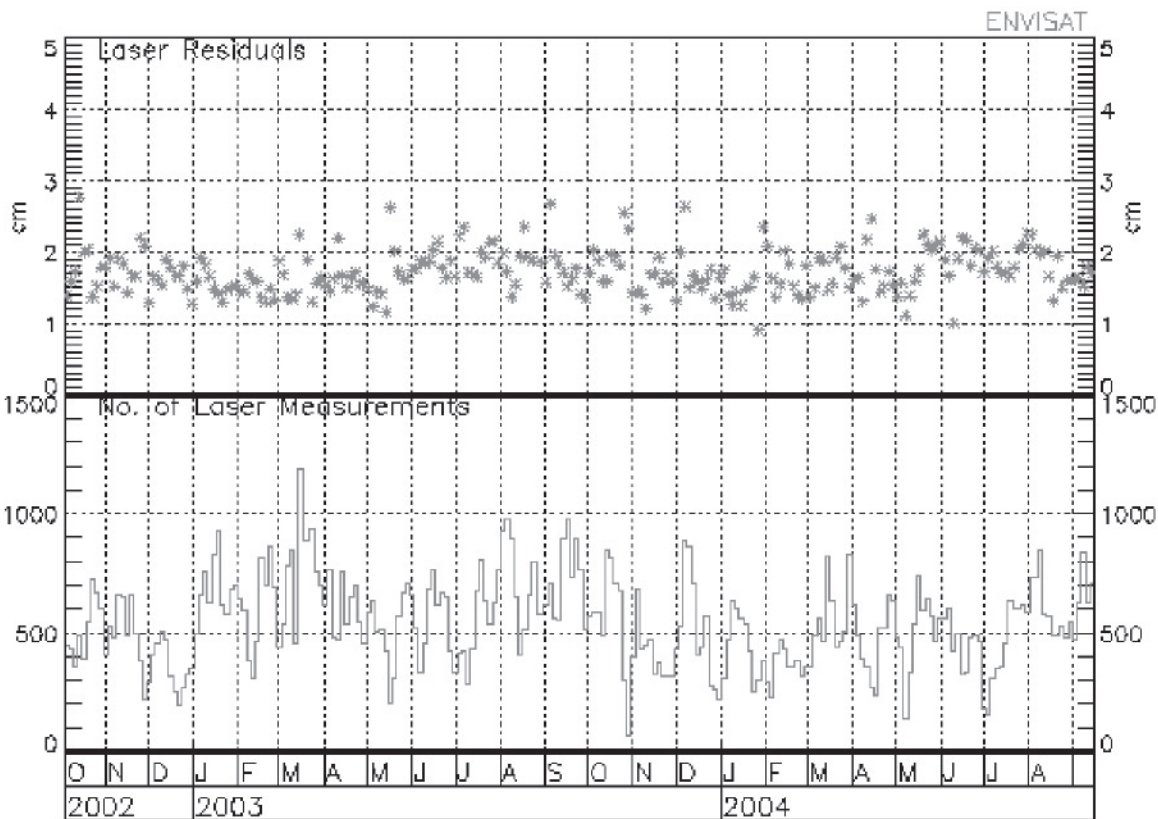

Figure A-6. Plot of range residuals and number of SLR normal points used in the precise orbit determination of Envisat.

## Future Plans

Besides the on-going routine activities for ERS-2 and Envisat, the Navigation Support Office is preparing for the launch of Cryosat, where SLR tracking data again will play an important role in the monitoring of ESOC's operational and predicted orbit solutions.

## Contacts

John Dow (Head of Navigation Support Office)  
ESA/ESOC, Robert-Bosch-Strasse 5  
D-64293 Darmstadt  
GERMANY

Voice: +49 6151 902272  
Fax: +49 6151 903129  
E-mail: [John.Dow@esa.int](mailto:John.Dow@esa.int)

Rene Zandbergen (Navigation Support Office)  
ESA/ESOC, Robert-Bosch-Strasse 5  
D-64293 Darmstadt, Germany  
GERMANY

Voice: 49 6151 902236  
Fax: 49 6151 903129  
E-mail: [Rene.Zandbergen@esa.int](mailto:Rene.Zandbergen@esa.int)



---

# Forsvarets Forskningsinstitutt (FFI) Associate Analysis Center

*Per Helge Andersen/FFI*

## Introduction

During the past 20 years FFI has developed a software package called GEOSAT for the combined analysis of VLBI, GPS, SLR, and other types of satellite tracking data (GLONASS, DORIS, PRARE and altimetry, etc). The observations are combined at the observation level with a consistent model and consistent analysis strategies. The data processing is automated except for some manual editing of the SLR observations.

In the combined analysis of VLBI, GPS, and SLR observations the data are processed in arcs of 24 hours defined by the duration of the VLBI session. The result of each analyzed arc is a state vector of estimated parameter corrections and a Square Root Information Filter (SRIF) array containing parameter variances and correlations. The individual arc results are combined into a multi-year global solution using a Combined Square Root Information Filter and Smoother program called CSRIFS. With the CSRIFS program any parameter can either be treated as a constant or a stochastic parameter between the arcs. The estimation of multi-day stochastic parameters is possible and extensively used in the analyses.

## Recent Activities

The GEOSAT software has undergone extensive changes and improvements during 2003-4. No major ILRS-related multi-year analyses have been performed with the software in 2003. The most important recent changes implemented in 2003 are described below.

- A new major software component of GEOSAT has been developed for 3D ray tracing through the atmosphere. A complete 3D atmospheric model provided daily by ECMWF is input to the software. Based on the available tracking data (VLBI, GPS, or SLR) for that specific date, a set of tables for each active station is automatically generated with information about the time delay in the different elevation and azimuth directions. Statistical information concerning the variability of relevant parameters is also extracted from the ECMWF data. This information is used in the estimation filter as time-dependent parameter constraints. In most of the VLBI-sessions analyzed thus far, this seems to be a very good strategy. No mapping functions are used anymore in GEOSAT when NWM data are available. Different interpolation schemes are under testing. An interpolation strategy has been found where the interpolation error is presently 1 mm or less down to an elevation cut-off of 2.7 degrees.
- A new model/parameterization for the atmospheric delay is under consideration in GEOSAT. Approximately 700 individual VLBI-only sessions have been analyzed thus far. A clear reduction in a posteriori residuals (typically 20-25%) is observed using the ECMWF data. The Grueger model is the default for the MW refractive index and the Ciddor model is default for the optical or near optical wavelengths. The Ciddor model implementation has been verified against Ciddor's own software.
- The pressure loading tables provided by Leonid Petrov have been implemented in GEOSAT. For stations not included in Petrov's tables, a simple pressure scaling model is used where the load scale parameter is automatically estimated in the analysis. A grid of reference pressure values has been derived by averaging the surface pressure levels provided by NCEP during the last 20 years.
- A model for thermal deformation of the VLBI antenna structure has been included and is used as default in the analyses. Thermal coefficients and thermal time delays can in principle be estimated.
- The station eccentricity file has been checked in great detail and updated with all the most current log files of VLBI, GPS, and SLR. The eccentricity information is treated as a new observation type in GEOSAT in addition to the VLBI, GPS, and SLR observation types.

- The GEOSAT software calculates one set of station coordinates and velocities for a reference marker at a collocated station in addition to the eccentricity vector to each different antenna reference point. The software has been extended so that observations from several active VLBI systems, GPS receivers, and SLR systems all will contribute to the estimation of the parameters for the station reference marker. The instruments could be operating either simultaneously or in different time windows.
- The IERS 2003 Conventions have been fully implemented including the new EOP parameterization.
- The absolute GPS satellite antenna phase center table published by Rothacher recently has been implemented as an a priori model. The parameters will be estimated during the analysis.
- All relevant partial derivatives have been verified against numerical partial derivatives.
- In the global processing of several years of data the stable sources listed by Feissel et al. will automatically be estimated as constants while the others will be estimated as random walk parameters or session parameters. A set of defining stations satisfying certain criteria is automatically estimated as constants where the other stations are estimated as constants during a certain interval (between one day and one month).
- Observations from the Galileo navigation system will be applied when available. Only minor changes in GEOSAT are required for this extension.
- The GEOSAT software has been extended to the analysis of tracking data for spacecrafts in the solar system. So far, one-, two-, and three-way Doppler data have been implemented and tested with satisfactory results. The software will be used for orbit determination of the ROSETTA, Messenger and BepiColombo spacecrafts.
- The GEOSAT software has been used for a combined analysis of selected LAGEOS SLR data and LAGEOS radar tracking data for the ultra-precise calibration of the GLOBUS-II radar in Vardø, Norway. This activity will continue for the next few years.

## Contact

Dr. Per Helge Andersen  
Division for Electronics (FFI)  
P.O. Box 25  
N-2007 Kjeller  
NORWAY

Voice: 47-63-807407  
Fax: 47-63-807212  
E-mail: per-helge.andersen@ffi.no

---

# Main Astronomical Observatory of the National Academy of Sciences of Ukraine (GAOUA) Associate Analysis Center

*Olga Bolotina/GAOUA*

## Introduction

The Main Astronomical Observatory of the National Academy of Sciences of Ukraine as an associate analysis center (GAOUA AAC) has been involved in space geodynamical research. Results of the SLR data analysis have been sent to the ILRS since 1993. Information about GAOUA AAC is available on the webpage of the Ukrainian Centre of Determination of the Earth Orientation Parameters <http://www.mao.kiev.ua/EOP/>.

The primary interests of the GAOUA AAC are

- data processing of the SLR observations
- software development
- control of the Ukrainian permanent SLR network
- archive of the observations for local needs.

Unique Kiev-Geodynamics software is used for SLR data analysis. Software has been developed at the Main Astronomical Observatory since 1984 by a scientific group composed of Vladimir Tarady, Valery Salyamov, Konstantin Nurutdinov, and Mikhail Tsesis. In subsequent years, Sergei Rudenko and Olga Bolotina have carried out the software development. Software Kiev-Geodynamics was created for the OS-360/370 operating system and was written in the FORTRAN-IV programming language. The software interface was written in C. The software makes estimations of the following parameters: Earth orientation parameters, coordinates and velocities of a selected set of stations, and satellites orbit elements. Models and methods recommended by IERS Conventions 1996 and 2000 are used in the Kiev-Geodynamics software. In 2003, the development of the Kiev-Geodynamics version 6.0 software was started. The new version will be converted from FORTRAN-IV to standard ANSI FORTRAN-77 for the Linux operation system.

The GAOUA AAC controls and coordinates the Ukrainian permanent SLR network:

- quality control of the observation data of SLR stations
- coordination of work of the Ukrainian permanent SLR stations network
- analysis of data from the Ukrainian permanent SLR stations network
- particular service of the Ukrainian permanent SLR stations.

A collection of the observation data from all Ukrainian permanent SLR stations is kept in the local archives. Data from Ukrainian permanent SLR stations are sent to the GAOUA AAC for archive and analysis.

## Current Activities

- Processing of all available LAGEOS-1 and LAGEOS-2 SLR tracking data taken since 1984 for new station coordinates and velocities solution
- Determination of the long-term stability of SLR stations coordinates and velocities
- Submission of a global SLR solution to the ITRF

## Future Plans

- Development of the Kiev-Geodynamics version 6.0 software
- Continue the SLR IERS and ITRF products submission
- Operational analysis of the SLR observations
- Participation in future ILRS pilot projects

## Contact

Dr. Olga Bolotina  
Department of Space Geodynamics  
Main Astronomical Observatory of the  
National Academy of Sciences of Ukraine  
Akademika Zabolotnoho Str., 27  
Kiev, 03680  
UKRAINE

Voice: +38 (044) 266-21-47  
Fax: +38 (044) 266-21-47  
E-mail: [olga@mao.kiev.ua](mailto:olga@mao.kiev.ua)

# Geoscience Australia Associate Analysis Center

*Ramesh Govind/Geoscience Australia*

## Background/Introduction

The Geoscience Australia associate analysis center has been routinely processing LAGEOS-1 and LAGEOS-2 data for satellite for orbit determination, station coordinates, Earth Orientation Parameters and SLR station performance monitoring. In addition, on an opportunity or project basis, Stella, Starlette, TOPEX and Jason data are also processed for evaluating the new CHAMP and GRACE gravity field models using orbit analysis. There is an ongoing emphasis on the co-location and combination of SLR with other space geodetic techniques. The major current effort is directed towards a multi-year multi-technique combination solution comprising all in-house solutions for SLR, GPS, DORIS, and VLBI. The SLR solutions for LAGEOS-1 and LAGEOS-2 have been completed for the period 1992 thru October 2004—estimating satellite orbits, station coordinates and Earth Orientation Parameters—establishing a long-term time series.

## Facilities/Systems

The current computation facilities in the Geoscience Australia Space Geodesy analysis center consist of three multi-CPU HP L2000 workstations and a HP cluster composed of ten rx2600 servers. The processing system uses the GEODYN suite of programs for orbit determination and geodetic parameter estimation as the engine. NASA's SOLVE program and IGN's CATREF are used for the combination solutions. A suite of programs has been developed in house for analysis and re-formatting. Final results are provided in the SINEX format.

## Current Activities

The current activities are:

- Completing the LAGEOS-1 and LAGEOS-2 time series for station coordinates, EOP, and station performance as far back as possible
- Continuing weekly solutions for LAGEOS-1 and LAGEOS-2 for EOP and station coordinates
- Monitoring station performance (range and time bias and pass-by-pass precision) for the new Mount Stromlo station
- Continuing to process Stella, Starlette, TOPEX, and Jason data for evaluating new global gravity field models from CHAMP and GRACE

## Future Plans

- Continue to provide both weekly LAGEOS-1 and LAGEOS-2 solutions.
- Submit solutions to the IERS SINEX combination campaign.
- Comparison of SLR solutions for LEOs with GPS and DORIS determined solutions.

## Related Publications

The key publications appear on Geoscience Australia's Space Geodesy analysis center Web page at <http://www.ga.gov.au/nmd/geodesy/sgc/report.htm/>.

## Contact

Dr. Ramesh Govind  
 Director, Space Geodesy and Geomagnetism  
 Geohazards Division  
 Geoscience Australia  
 PO Box 378, Canberra, ACT 2601  
 AUSTRALIA

Voice 61 2 624 99033  
 Fax: 61 2 624 99929  
 E-mail: [Ramesh.Govind@ga.gov.au](mailto:Ramesh.Govind@ga.gov.au)

## GeoForschungsZentrum Potsdam (GFZ) Associate Analysis Center

Rolf Koenig, Franz-Heinrich Massmann, Roland Schmidt/GFZ

### Activities in Support of ILRS

#### *Provision of orbit predictions for ERS-2, CHAMP, GRACE-A and -B*

The normal ERS satellite prediction interval is about two weeks unless maneuvers make immediate updates necessary. The orbit predictions are updated daily with time bias functions. The prediction accuracy after one day is typically about 2 ms in time bias. For CHAMP, the orbit predictions are updated three times per day. A survey result among the stations showed that this update interval is sufficient. The accuracy of the predictions is continuously monitored in order to enhance the update frequency if necessary. At the time of the writing of this report, the prediction accuracy stays below 10 ms in time bias over nine hours. So, the current prediction update of every eight hours should allow for safe tracking. The GRACE predictions are less affected by atmospheric orbit perturbations than the lower-orbiting CHAMP satellite. Therefore an update frequency of 12 hours is currently used for the GRACE predictions.

**Table A-2. Generated Orbit Prediction Products (01/01/2003 - 30/09/2004)**

	ERS-2	CHAMP	GRACE-A	GRACE-B
Time Bias Functions	548	-	-	-
Drag Functions	-	11818478	1188	1202
Two-Line Elements	99	1847	1188	1202
SAO Elements	99	1847	1188	1202
Total	845	7388	4752	4808
Scheduled Predictions	N/A	1914	1276	1276
Operations Success (%)	N/A	96.5	93.1	94.2

#### *Provision of position and EOP parameters from LAGEOS-1 and -2 analyses*

GFZ joined the ILRS analysis working group (AWG) activities on the so-called pos+eop pilot project in 2003. Since then, station position estimates and Earth orientation parameters from LAGEOS analyses have been submitted regularly in the form of SINEX files. Accuracies of the 3D position estimates are assessed by outside institutes at 0.01 meters, of the polar motion parameters at 0.0003 arc seconds, and of the excess length of day (LOD) parameters at 0.0001 seconds.

**Table A-3. Pos+EOP Products**

Type	Period	Satellites	Number of SINEX Files
28-d arcs	01/06/2003-11/11/2003	LAGEOS-1, -2	24
7-d arcs	18/11/2003-30/09/2004	LAGEOS -1, -2	64

## Further Activities Involving SLR Data

- Systematic generation of the ERS-2 preliminary and precise orbits based on SLR and PRARE data under ESA contract
- Monitoring of CHAMP and GRACE operational POD
- Generation of CHAMP, GRACE, and satellite-only gravity field models and combined gravity field models from satellite and surface gravity data
- Combination of GPS and low Earth orbiter (LEO) observations for reference frame and long wavelength gravity field resolution

## Future Plans

- Process and analyze LAGEOS-1 and LAGEOS-2 tracking data taken since 1993 following the call for contribution to the ITRF2004 and the IERS combination pilot project (CPP)
- Etalon-1 and Etalon-2 data processing has been tested and will be included in the operational pos+eop product generation

## Contact

Dr. Rolf Koenig  
GeoForschungsZentrum Potsdam (GFZ)  
Dep. 1: Geodesy and Remote Sensing  
c/o DLR Oberpfaffenhofen  
D-82234 Wessling  
GERMANY

Voice: 49-8153-28-1353  
Fax: 49-8153-28-1735  
E-mail: rolf.koenig@gfz-potsdam.de

## Institute of Applied Astronomy (IAA) Associate Analysis Center

*Iskander Gayazov, George Krasinsky, Tamara Ivanova, Zinovy Malkin, Nadia Shuygina/IAA*

In 2003-2004 two laboratories of the Institute of Applied Astronomy RAS (IAA) were involved in analysis of SLR and LLR data.

### Laboratory of Ephemeris Astronomy

The following investigations were performed by this group (G. Krasinsky, N. Shuygina, T. Ivanova) using ERA software:

- SLR observations of LAGEOS-1, LAGEOS-2, Etalon-1, Etalon-2 have been processed in the frame of the first part of the AWG Pilot Project “benchmarking and orbits” and submitted to AWG.
- Development continues on the technique to determine the EOP series from the joint analysis of SLR and VLBI measurements at the observation level. We used LAGEOS-1, LAGEOS-2, Etalon-1, and Etalon-2 data and VLBI measurements of quasars obtained in the NEOS campaign. SLR and VLBI observations are mixed to determine both Earth rotation parameters and corrections to satellite orbital parameters, coefficients for the radiation pressure reflectance model and along track acceleration terms, zenith component of troposphere delay and its gradients. A Kalman filtering procedure was used to solve the joint system of conditional equations. Table A-4 shows root mean square and formal uncertainties of the one-month EOP set as compared with that of EOP (IERS) C 04 obtained from different sets of observations (pure VLBI observations or VLBI measurements combined with that of SLR). Moreover, applying Kalman method to the whole time span allows us to derive EOP variations with sub-diurnal periods.

**Table A-4. One-month EOP set**

<b>Parameter</b>	<b>SLR rms</b>	<b>SLR formal</b>	<b>VLBI rms</b>	<b>VLBI formal</b>	<b>VLBI+SLR rms</b>	<b>VLBI+SLR formal</b>
Xp, mas	0.23	0.07	0.07	0.13	0.19	0.11
Yp, mas	0.27	0.06	0.16	0.13	0.20	0.10
UT1, ms			0.011	0.007	0.013	0.019
dψ, mas			0.18	0.22	0.31	0.41
dε, mas			0.24	0.11	0.26	0.26

- A study of time variations of lower harmonics of the geopotential has been done. Satellite laser ranging to the Etalon-1 and Etalon-2 satellites for 1992-2001 was processed to investigate the behavior of the second order harmonics  $C_{21}$ ,  $S_{21}$  of the geopotential. The main aim is to estimate the  $K_1$  tidal wave in the tesseral harmonics  $C_{21}$ ,  $S_{21}$  which manifests itself as sinusoidal oscillations  $\Delta C_{21}$ ,  $\Delta S_{21}$  with the period of one sidereal day, given in IERS Conventions 2003 the value  $K_1=471.8 \cdot 10^{-12}$ . This wave is caused by the differential rotation of the Earth's fluid core and so is very informative for geophysics. The  $K_1$  obtained from the Etalon satellites somewhat differs from the conventional value given above. A theory has been developed (Krasinsky, 2003) to present this coefficient in terms of a dynamical Love number  $K_2^d$  that enters the nutation theory.
- LLR observations of 1969-2004 have been processed with the original dynamical model. The improved lunar ephemerides are accepted for use in the Russian Astronomical Yearbook.



## Laboratory of Space Geodesy and Earth Rotation

The following investigations were performed by this group (I. Gayazov, Z. Malkin) using GROSS and GRAPE software.

- The Lab of Space Geodesy and Earth Rotation continued daily operational processing of LAGEOS-1 and LAGEOS-2 observations using the GROSS software. The new version of the software implements some improvements. Operational EOP series with a delay of about two days are automatically computed every day, and submitted to the OPA and NEOS combination centers. In 2003 and 2004, two new final SLR EOP series were computed and submitted to IERS annual reports.
- An 8-year time span of LAGEOS-1 and LAGEOS-2 SLR data have been processed by the GRAPE program package (Gayazov *et al.*, 2000) to analyze long-term variations of  $C_{21}$ ,  $S_{21}$  geopotential coefficients. The first-degree harmonic coefficients  $C_{10}$ ,  $C_{11}$ ,  $S_{11}$ , which are equivalent to the geocenter offsets, and the corrections to  $C_{20}$  coefficient were also included in 10-day solutions.

The aim of the work was to verify the adequacy of the dynamic pole tide formulation in the latest issue of the IERS Conventions. The analysis allowed us to determine corrections to the linear model for  $C_{21}$ ,  $S_{21}$  coefficients based on the mean rotational pole path of the Earth. The amplitudes of variations corresponding to the Chandler period are rather small, but noticeable long-term variations with a period of about 1200 days were obtained, which will be investigated further.

The geocenter offsets were calculated from the series of harmonic coefficients  $C_{10}$ ,  $C_{11}$ ,  $S_{11}$ . Amplitudes of annual period found from this analysis are in good agreement with other results obtained during the geocenter motion analysis campaign.

## References

- Krasinsky, G.A., Rotation of the deformable Earth with the viscous fluid core. Comm. of the IAA RAS, St.Petersburg, 2003.
- Gayazov, I.S., Keshin M. O., Fominov A.M. 2000. GRAPE software for GPS data processing: first results of ERP determinations. In: IGS Network Workshop 12-14 July 2000, Oslo. Extended abstracts.
- Gayazov, I.S. Variations of  $C_{21}$ ,  $S_{21}$  geopotential coefficients from SLR data of LAGEOS satellites. In: Astrometry, Geodynamics and Solar System Dynamics: from milliarcseconds to microarcseconds. Journees 2003. St. Petersburg, 2004.

## Contact

Dr. Zinovy Malkin  
Institute of Applied Astronomy  
Zhdanovskaya St. 8  
St. Petersburg, 197110  
RUSSIA

Voice: 7-812-235-32-01  
Fax: 7-812-230-74-13  
E-mail: malkin@quasar.ipa.nw.ru

## Japan Aerospace Exploration Agency (JAXA) Associate Analysis Center

*Shinichi Nakamura, Takashi Uchimura/JAXA*

### Introduction

One of the tasks of the JAXA associate analysis center is to provide precise orbit determination for Ajisai, LAGEOS-1, LAGEOS-2 and LRE. Furthermore, JAXA is now preparing for the operation of future satellites such as ALOS and ETS-VIII.

### Facilities/Systems

JAXA developed and completed a precise orbit determination system that uses GPS data and SLR data. In comparison with last year, we adopted many corrections such as the effect of the ocean tide and the effect of rotating receiver through the precise orbit determination of GPS satellite. The JAXA SLR station in Tanegashima was completed in the end of March 2004, but has suffered some damage due to several recent typhoons.

### Current Activities

- Processing SLR tracking data of Ajisai, LAGEOS-1, LAGEOS-2, and LRE.
- Generating IRVs of the above satellites.
- Processing GPS satellite data (QLNP and RINEX) for precise orbit determination. Comparison of our orbit determination results with those of the IGS analysis centers show that our precise orbit determination system has nearly equivalent performance to IGS analysis center.
- Monitoring and evaluating SLR station performance. The results are available on our Web site, <http://god.tkse.jaxa.jp/slreport>.
- Analyzing the data obtained from ADEOS-2. The analysis shows that the achieved accuracy of our orbit determination is within about 40cm (RMS) for the ADEOS-II orbit.

### Near-Future Projects

#### ***ALOS***

ALOS will be launched by JAXA in the 2005 fiscal year. The ALOS satellite carries two optical sensors (PRISM, AVNIR-2), which are vulnerable to a laser beam. JAXA has carried out the following examination in order to prevent the laser beam from damaging the ALOS optical sensors:

- Investigation of the threshold value of optical sensor in ALOS and calculation of the link budget.
- Analysis of the satellite visibility, which includes the restricted areas where laser transmission cannot be performed, and study of the operational method in ALOS.

The threshold value of each sensor was found to be  $5 \pm 10^{14}$  (w/m<sup>2</sup>). JAXA carried out the link budget calculation in consideration of the station performance and this threshold value. This analysis shows that the laser beams from all ILRS stations may exceed the threshold value and we must carry out SLR operation in consideration of these restrictions. The SLR restriction area by the optical sensor of ALOS is shown in Figure A-7.

Interference with the PRISM sensors will be avoided if the SLR stations restrict operations to below 81.8 degrees elevation. AVNIR-2 operates with a swath width of  $\pm 44$  degrees from nadir and it interferes with SLR stations at low elevation ( $\sim 32.4$  deg). JAXA will request supporting SLR stations to range ALOS at an elevation angle of 81 degrees or less, and JAXA will consider a sufficient margin for the actual interference period with AVNIR-2. The information

which includes restriction information will be provided by JAXA to the registered stations directories {in the same form as GP-B) to avoid vulnerable periods.

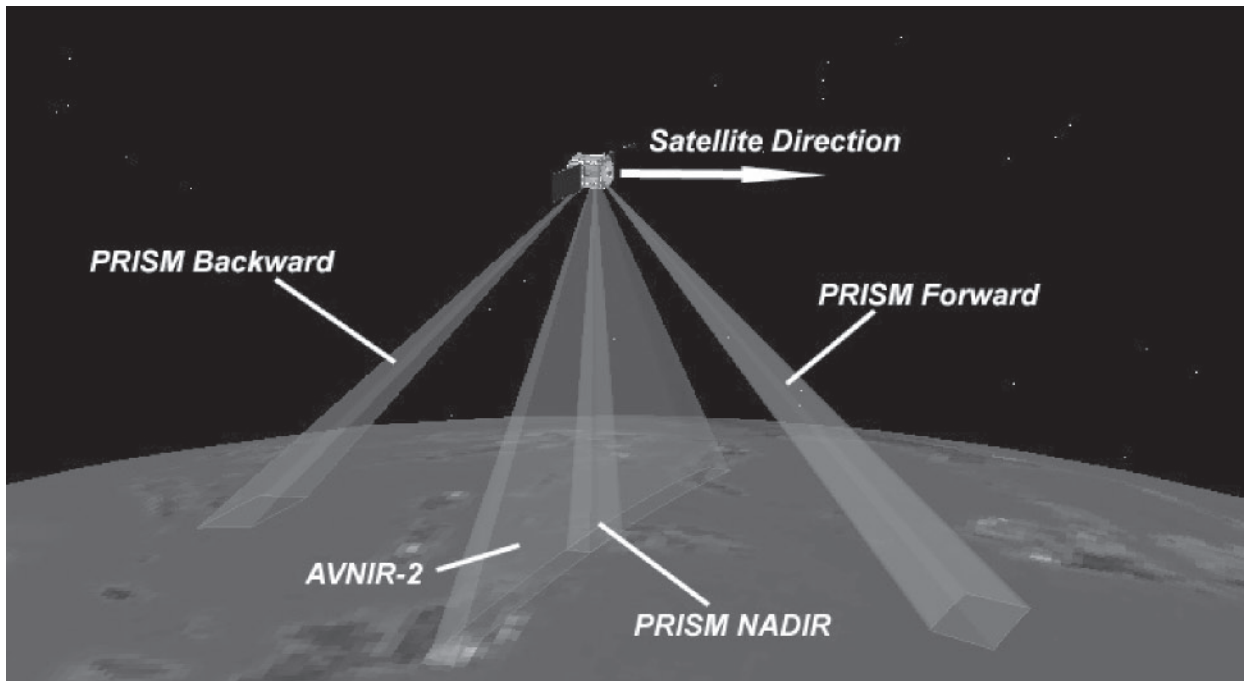

Figure A-7. Observation area of optical sensor in ALOS

### **ETS-VIII**

ETS-VIII, a JAXA geostationary satellite, will be launched in fiscal year 2006 and placed at 147 degrees east longitude. Only WPLTN station can perform SLR ranging to this satellite. JAXA carried out the link budget calculation in consideration of the station performance and checked the possibility of SLR. As an analysis result, candidate stations for ETS-VIII tracking are the JAXA station, Mt. Stromlo, Koganei, and Kunming. JAXA will request these candidate stations to perform SLR tracking on ETS-VIII for about five minutes per one hour every two weeks. JAXA will use a new TIRV format being considered for LLR.

### **Future Plans**

The observational model of our system will change from the IERS 1996 standard to the IERS 2003 standard.

### **Contacts**

Sinichi Nakamura, Takashi Uchimura  
 Flight Dynamics Division  
 Consolidated Space Tracking and Data Acquisition Department  
 Office of Space Flight and Operations, JAXA  
 JAPAN

Voice: +81-29-868-2624/2625  
 Fax: +81-29-868-2990

## JCET/GSFC ILRS Associate Analysis Center

*Erricos Pavlis/JCET*

### Introduction

The JCET/GSFC AAC continued its ILRS activities during the period 2003-04. In addition to continued contributions to the ILRS Pilot Project, we also submitted contributions to IERS's ITRF Pilot Project and the IERS Combination Pilot Project. In connection with the latter, our contribution comprises a twelve-year series (1993-2004) of weekly SINEX files with positions and EOP. Since April 2001, we routinely analyze LAGEOS-1 and -2, and Etalon-1 and -2 data for the generation of these products. We are also coordinating the benchmarking process for new candidate analysis centers for the ILRS. In terms of scientific achievements, we developed and published a new, improved zenith delay model for atmospheric refraction valid for all optical wavelengths used in SLR at present. In collaboration with an Italian group of physicists we published an improved test of the relativistic Lense-Thirring frame-dragging prediction. The weekly and annual products of our analysis were used to detect and estimate the effect of the large Sumatra earthquake on Earth's EOP and centre of mass.

### Background

The activities of the AAC are primarily focused on the analysis of SLR data from LAGEOS, LAGEOS-2, Etalon-1 and -2, as required for the generation of ILRS products. The products supported to date are weekly station positions (and velocities for the multi-year solutions) and the Earth Orientation Parameters,  $x_p$ ,  $y_p$ , and LOD at daily intervals. In support of the ITRF Pilot Project we also form weekly solutions, which are transformed into SINEX format for general distribution. The weekly sets of normal equations are also used to derive a weekly resolution series of "geocenter" offsets from the adopted origin of the reference frame, defined by the multi-year solution. These series were examined in terms of their spectral content by estimating periodic signals at long and intermediate wavelengths. Comparisons to series obtained from primarily geophysical model predictions, indicate a high correlation to the seasonal redistribution of geophysical fluids in the Earth system.

### Facilities/Systems

These are the same as for previous years.

### Current Activities

The generation of weekly solutions as a contribution to the IERS/ITRF Pilot Projects and the monitoring of episodic and seasonal variations in the definition of the geocenter with respect to the origin of the conventional reference frame continued. In a parallel and related activity, we added and validated new modeling capabilities to NASA's s/w GEODYN II, the upgrade of the reference frame model to comply with the IAU2000 resolutions, utilization of the new zenith delay model for atmospheric delay, and the orbit and s/w benchmarking projects. A re-analysis of the 12-year series using the new s/w for the deliverable products was completed in 2004. These products were used to identify the effect of transient geophysical events such as the El Niño/La Niña oscillation (Fig. A-8) and the large Sumatra earthquake of Dec. 26, 2004, on estimated quantities such the orientation of the pole, LOD, and Earth's centre of mass (Fig.A-9).

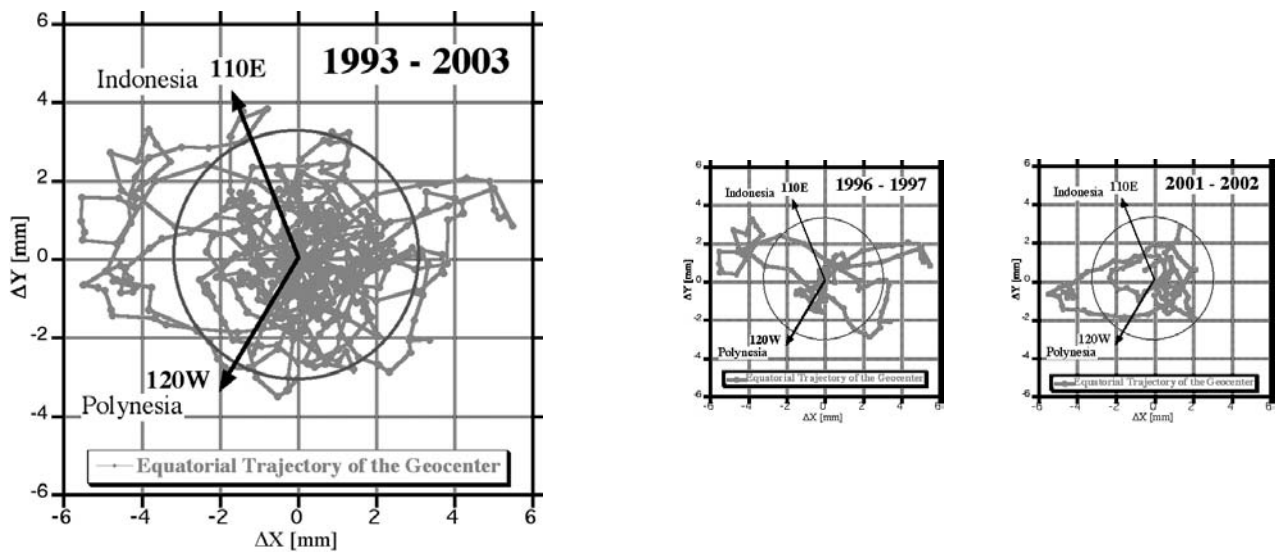

Figure A-8. Equatorial trajectory of the geocenter for the 1993–2003 period (60-day boxcar-smoothed weekly estimates). The 3-mm circle indicates average motion, while the arrows indicate the geographical areas associated with excursions during El Niño /La Niña years. The two figures on the right illustrate the departure of the geocenter from nominal motion during the two recent El Niño /La Niña events.

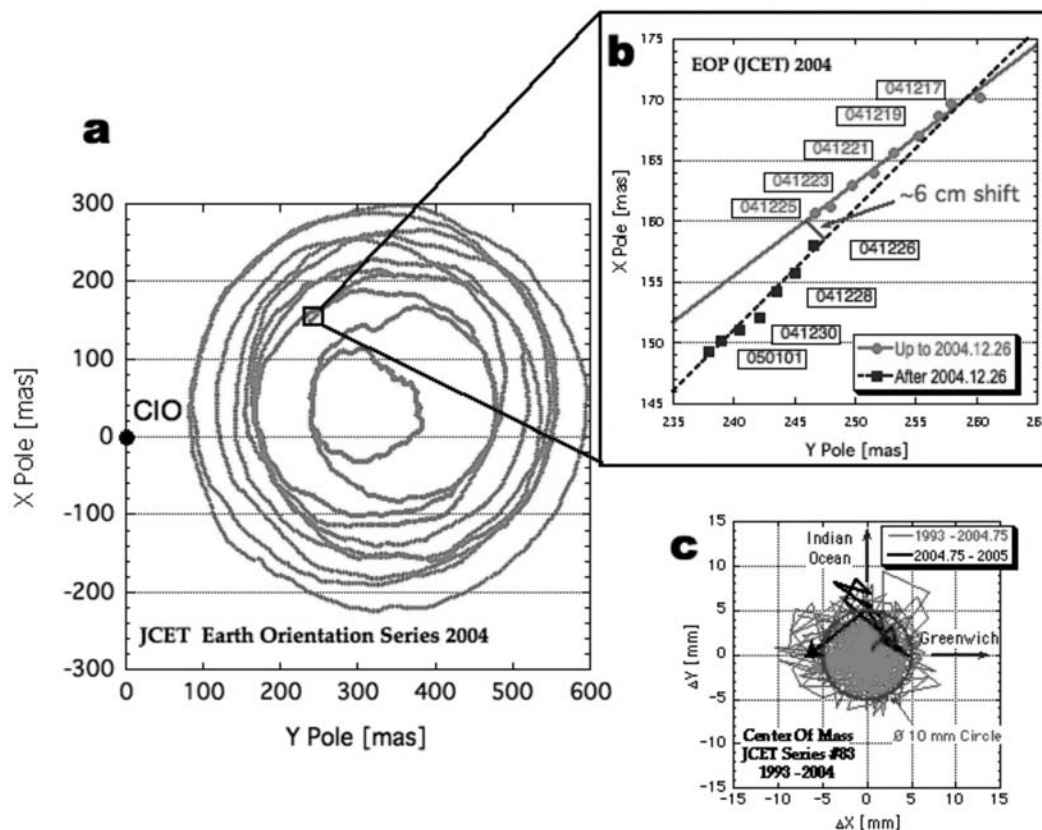

Figure A-9. Observations of transient signals associated with the Sumatra earthquake. a) 12-year path of the rotational axis near the North Pole, 1993-2005. b) The path during 04/12/16 to 05/01/01, illustrating the 6 cm offset. c) Equatorial projection of the 12-year path of Earth's centre of mass Jan. 1993 to Sept. 2004 (red) and Oct. 2004 to Jan. 2005 (black), with the unexpected motion between the last two weeks.

## Future Plans

ILRS-related activities will continue, with emphasis on the near-real-time generation of weekly products and their dissemination via the web. We are extending our analysis to years prior to 1993, with an initial plan to complete weekly SINEX files beginning with 1983. Emphasis will be given on Mean Sea Level monitoring applications and the quantification and understanding of various error sources associated with this research topic.

## References, Publications, Presentations (2003-2004)

- Clarke, P.J., G. Blewitt, D.A. Lavallee, and E.C. Pavlis, Comparison of Geometric and Gravimetric Estimates of Surface Mass Transfer: Constraints on Geocenter Motion and Low-degree Love Numbers, *EOS Trans. AGU*, 84 (46), Fall Sci. Meet. Suppl., Abstract G21A-04 (INVITED), 2003.
- Ciufolini, I. and E.C. Pavlis, A confirmation of the general relativistic prediction of the Lense-Thirring effect, *Nature*, 431, 958-960 (2004).
- Lucchesi, D.M., E.C. Pavlis, I. Ciufolini, R. Peron, "The Yarkovsky-Schach thermal effect on LAGEOS satellites and its modeling", *Geoph. Res. Abs.*, 5, EAE03-A-07494, April 2003.
- Lucchesi, D.M., I. Ciufolini, J.I. Andrés, E.C. Pavlis, R. Peron, R. Noomen, D.G. Currie, "LAGEOS II perigee rate and eccentricity vector excitations residuals and the Yarkovsky-Schach effect", *Planetary and Space Science*, 52 (2004) 699-710, DOI:10.1016/j.pss.2004.01.007, Elsevier Science B.V., Amsterdam, The Netherlands, 2004.
- Mendes, V. and E.C. Pavlis Atmospheric Refraction at Optical Wavelengths: Problems and Solutions, Proceedings of the 13th International Laser Ranging Workshop, Washington DC, USA, October 7-11, 2002, electronic publication (CD), NASA Goddard, Greenbelt, MD 2003.
- Mendes, V. and E.C. Pavlis "High-Accuracy Zenith Delay Prediction at Optical Wavelengths", *Geophysical Res. Lett.*, 31, L14602, doi:10.1029/2004GL020308, 2004.
- Pavlis, E.C., The origin of the TRF from laser ranging, *Geophysical Res. Abstracts Vol. 5*, Abstract EAE03-A-06958, April 2003.
- Pavlis, E.C., Daily Earth orientation parameters from laser ranging, *Geophysical Res. Abstracts Vol. 5*, Abstract EAE03-A-06985, April 2003.
- Pavlis, E.C., Time series of weekly TRF realizations from laser ranging to LAGEOS-1 & -2, *Geoph. Res. Abs.*, 5, EAE03-A-07025, April 2003.
- Pavlis, E.C., "The JCET/GSFC contributions to the 6th/7th ILRS Pilot Project", ILRS Analysis Working Group Meeting, Nice, France, April. 3-4, 2003.
- Pavlis, E.C., Monitoring the origin of the TRF with space geodetic techniques, in *Proc. 13<sup>th</sup> Inter. Laser Ranging Workshop*, (eds. S. Klosko, C. Noll & M. Pearlman), NASA CP 2003-212248, NASA Goddard, (2003).
- Pavlis, E.C., (2003) SLR Data Analysis for Geophysical Series, 2003 ILRS Technical Workshop, 26-30 October, 2003, Kötzing, Germany.
- Pavlis, E.C., (2003) Low Elevation Data Analysis -- Grasse 7845, 2003 ILRS Technical Workshop, 26-30 October, 2003, Kötzing, Germany.
- Pavlis, E.C., (2003) CoM offset for Etalon-1 & -2, 2003 ILRS Technical Workshop, 26-30 October, 2003, Kötzing, Germany.
- Pavlis, E.C., (2003) QL (Preliminary) System Positioning -- The FTLRS @ Chania Case, 2003 ILRS Technical Workshop, 26-30 October, 2003, Kötzing, Germany.

- Pavlis, E.C., Satellite Laser Ranging Observations of the TRF Origin, *EOS Trans. AGU*, 84 (46), G21A-03 (2003).
- Pavlis, E.C., Satellite Laser Ranging Observations of the TRF Origin, *First Joint JCET-GEST Symposium*, January 22, 2004, NASA Goddard, 2004.
- Pavlis, E.C., TRF Monitoring with Satellite Laser Ranging, 2004 EGU, 26-30 April, 2004, Nice, France, *Geophysical Research Abstracts*, Vol. 6, 04258, 2004.
- Pavlis, E.C., EOP series from the JCET/GSFC SLR TRF solution 2003, 2004 EGU, 26-30 April, 2004, Nice, France, *Geophysical Research Abstracts*, Vol. 6, 04168, 2004.
- Pavlis, E.C. and G. Hulley, (2003) Refraction Modeling Studies in Support of ILRS Data Analysis, 2003 ILRS Technical Workshop, 26-30 October, 2003, Kötzing, Germany.
- Pavlis, E.C. and G. Hulley, Advances in TRF monitoring with Satellite Laser Ranging, 35th COSPAR General Assembly, July 18-24, 2004, Paris, France.
- Pavlis, E.C., M. Kuzmicz-Cieslak and G. Hulley, (2003) Dual Wavelength Data Analysis, 423 & 846 nm, 2003 ILRS Technical Workshop, 26-30 October, 2003, Kötzing, Germany.
- Pavlis, E.C. and V. Mendes, (2003) Atmospheric Refraction at Optical Wavelengths: An update, 2003 ILRS Technical Workshop, 26-30 October, 2003, Kötzing, Germany.
- Pavlis, E.C., V. Mendes, D.E. Pavlis and G. Hulley, Atmospheric Refraction Modeling Improvements in Satellite Laser Ranging, 2004 EGU, 26-30 April 2004, Nice, France, *Geophysical Research Abstracts*, Vol. 6, 04206, 2004.

## Contact

Dr. Erricos C. Pavlis  
Joint Center for Earth Systems Technology, (JCET/UMBC)  
University of Maryland, Baltimore County  
1000 Hilltop Circle  
Baltimore, MD 21250  
USA

Voice: (410) 455-5832  
Fax: (410) 455-5868  
E-mail: [epavlis@UMBC.edu](mailto:epavlis@UMBC.edu)

## Jet Propulsion Laboratory (JPL) Lunar Associate Analysis Center

*James Williams, Dale Boggs, Slava Turyshev, Jean Dickey, and J. Todd Ratcliff/JPL*

### Status

Analyses of laser ranges to the Moon are used for a variety of investigations: lunar science, gravitational physics, geodesy, geodynamics and astronomy. Lunar Laser Ranging (LLR) analyses provide determinations of the Moon's tidal acceleration, orbit, three-dimensional rotation (physical libration), plus tidal deformation, determinations of fundamental constants and the Earth's rotation, orientation, precession, station locations and motions, plus tests of gravitational physics. Unique contributions from LLR include: detection of a molten lunar core; measurement of tidal dissipation in the Moon; an accurate test of the principle of equivalence for massive bodies (strong equivalence principle); and detection of lunar free librations.

### Activities

Lunar Laser Ranges are regularly received from the Observatoire de la Cote d'Azur (Grasse 7845) and McDonald Observatory (7080) sites. Four lunar retroreflector arrays are ranged, but about 80% of the data comes from the largest array at the Apollo 15 site. Global solutions for a number of parameters fit range data from the last decade with a weighted rms scatter of 2 cm. The ranges are processed at frequent intervals for Earth rotation information and the resulting sequences of UT0 and variation of latitude values for the two stations are input to the JPL Earth rotation filter. Tables of Earth rotation derived from a combination of techniques are available at the ftp site <ftp://euler.jpl.nasa.gov/keof/combinations>. Files and documentation for lunar and planetary ephemerides and lunar physical libration are available to the scientific community at the Web site <http://ssd.jpl.nasa.gov/horizons.html>. A description of the JPL planetary and lunar integration program and the generation of an ephemeris are given in (6).

The tidal acceleration of the Moon has been computed for several ephemerides based on iterated solutions. The acceleration in mean longitude due to dissipative effects is  $-25.7 \text{ "/cent}^2$ , of which  $-26.0 \text{ "/cent}^2$  is due to tides on Earth and  $+0.3 \text{ "/cent}^2$  is due to tidal and fluid core dissipation in the Moon (2). The tidal increase in semi major axis is 38 mm/yr.

Lunar science results continue (2, 5, 8-13). The solid-body tidal Q is low and has a weak dependence on tidal period. A fluid core is indicated with a size about 20% of the Moon's dimension. An oblate core-mantle boundary (CMB) can influence the determination of the Love number  $k_2$ . Preliminary attempts allowing for CMB oblateness give a lunar Love number  $k_2=0.0227$ , with uncertainty 0.0025 (12). Accurate positions of retroreflector arrays on the Moon will be valuable for future lunar missions (2, 9) and future missions may deploy additional arrays or optical transponders.

Uncertainties continue to improve for tests of gravitational physics (1, 2, 4, 7-9). The Earth and Moon are accelerated alike in the Sun's gravitational field to within  $1.4 \times 10^{-13}$  (7). This equivalence principle test is sensitive to differences between Earth and Moon due to both composition and gravitational self-energy. Tests of the relativistic geodetic precession and the Parametrized Post Newtonian beta and gamma agree with Einstein's General Relativity (1, 7). The equivalence principle test limits the beta uncertainty to 0.00011 and the gravitational constant G has no detectable rate for  $dG/dt / G$  within  $9 \times 10^{-13} / \text{yr}$  (7).

### Plans

Data analysis models will be improved (3) and Lunar Laser Ranges will be processed. Earth rotation results will continue to be generated. Investigation of lunar science and gravitational physics will continue along with lunar ephemeris and physical libration development. Ranges from several sites on the Earth to the several retroreflectors on the Moon are valuable. We will process data from sites with existing and future lunar capability (3) and we encourage lunar ranging from new sites on the Earth.



## References

### *Papers*

- 1) Williams J.G., D.H. Boggs, J.O. Dickey, and W.M. Folkner, Lunar Laser tests of gravitational physics, in proceedings of The Ninth Marcel Grossmann Meeting, World Scientific Publ., eds. V. G. Gurzadyan, R. T. Jantzen, and R. Ruffini, 1797-1798, 2002.
- 2) Williams, J.G. and J.O. Dickey, Lunar Geophysics, Geodesy, and Dynamics, Proceedings of 13th International Workshop on Laser Ranging, October 7-11, 2002, Washington, D. C., eds. R. Noomen, S. Klosko, C. Noll, and M. Pearlman, NASA/CP-2003-212248, pp. 75-86, 2003, [http://cddis.gsfc.nasa.gov/lw13/lw\\_proceedings.html](http://cddis.gsfc.nasa.gov/lw13/lw_proceedings.html).
- 3) Williams, J.G., S.G. Turyshev, and T.W. Murphy, Jr., Improving LLR Tests of Gravitational Theory, (Fundamental Physics meeting, Oxnard, CA, April 2003), International Journal of Modern Physics D, V13 (No. 3), 567-582, 2004. <http://www.worldscinet.com/ijmpd/13/1303/S0218271804004682.html>.
- 4) Turyshev, S.G., J.G. Williams, K. Nordtvedt Jr., M. Shao, T.W. Murphy Jr., 35 Years of Testing Relativistic Gravity: Where do we go from here?, in Proc. of "302.WE-Heraeus-Seminar: Astrophysics, Clocks and Fundamental Constants," 16-18 June 2003, the Physikzentrum, Bad Honnef, Germany, Springer Verlag, Lect. Notes Phys. v648, 311-330, 2004, gr-qc/0311039
- 5) Khan, A., K. Mosegaard, J.G. Williams, and P. Lognonne, Does the Moon possess a molten core? — Probing the deep lunar interior using results from LLR and Lunar Prospector, J. Geophys. Res., 109 (E9), E09007 doi:10.1029/2004JE002294, pp 1-25, 2004.
- 6) Standish, E.M. and J.G. Williams, Orbital Ephemerides of the Sun, Moon, and Planets, Chapter 8 of the Explanatory Supplement to the American Ephemeris and Nautical Almanac, in press, 2003.
- 7) Williams, J. G., S.G. Turyshev, and D.H. Boggs, Progress in lunar laser ranging tests of relativistic gravity, in press Phys. Rev. Lett., 2004.
- 8) Williams, J.G., D.H. Boggs, S.G. Turyshev, and J.T. Ratcliff, Lunar Laser Ranging Science, 14<sup>th</sup> International Workshop on Laser Ranging, June 7-11, 2004, San Fernando, Spain, submitted Sept. 2004.
- 9) Williams, J.G., S.G. Turyshev, D.H. Boggs, and J.T. Ratcliff, Lunar Laser Ranging Science: Gravitational Physics and Lunar Interior and Geodesy, 35th COSPAR Scientific Assembly, July 18-24, 2004, Paris, France, submitted to Advances in Space Research, 2004.

### *Abstracts*

- 10) Williams, J.G., D.H. Boggs, J.T. Ratcliff and J.O. Dickey, Lunar rotation and the lunar interior, abstract #1161 of the Lunar and Planetary Science Conference XXXIV, March 17-21, 2003.
- 11) Williams, J.G., J.T. Ratcliff, D.H. Boggs, and J.O. Dickey, Lunar Rotation, Orientation and Tides, American Geophysical Union meeting, Geodesy session G04, San Francisco, CA, Dec 8-12, 2003.
- 12) Williams, J.G., D.H. Boggs, and J.T. Ratcliff, Lunar Core and Tides, abstract #1398 of the Lunar and Planetary Science Conference XXXV, March 15-19, 2004.
- 13) Williams, J.G., J.T. Ratcliff, and D.H. Boggs, Lunar Rotation, Orientation and Science, American Geophysical Union meeting, Planetary Geodesy session G10, San Francisco, CA, Dec. 13-17, 2004.

## Contacts

James G. Williams

Voice: (818) 354-6466

E-mail: [James.G.Williams@jpl.nasa.gov](mailto:James.G.Williams@jpl.nasa.gov)

Dale H. Boggs

Voice: (818) 354-1630

E-mail: [Dale.H.Boggs@jpl.nasa.gov](mailto:Dale.H.Boggs@jpl.nasa.gov)

Slava G. Turyshev

Voice: (818) 393-2600

E-mail: [Slava.G.Turyshev@jpl.nasa.gov](mailto:Slava.G.Turyshev@jpl.nasa.gov)

Jean O. Dickey

Voice: (818) 354-3235

E-mail: [Jean.O.Dickey@jpl.nasa.gov](mailto:Jean.O.Dickey@jpl.nasa.gov)

J. Todd Ratcliff

Voice: (818) 354-0204

E-mail: [James.T.Ratcliff@jpl.nasa.gov](mailto:James.T.Ratcliff@jpl.nasa.gov)

Jet Propulsion Laboratory  
Mail Stop 238-332  
4800 Oak Grove Drive  
Pasadena, CA 91109-8099

Fax: (818) 393-6890

---

# Mission Control Center (MCC) Analysis Center

*Vladimir Glotov, Michail Zinkovsky/MCC*

## Introduction

The MCC has been involved in SLR data analysis since 1990 and is part of the MCC Navigation and Coordinate-time Service. The MCC analysis center uses three of its own software packages in routine activities: STARK, POLAR and STARK-AUTO&STARK-SYSTEM (SLR, GPS/GLONASS “phases” and code navigation data processing).

## Current Activities

### *Weekly EOP Estimation and SLR Network Quality Control*

The MCC started routine determination of EOP in cooperation with the IERS in 1993. Based on SLR data from the LAGEOS-1 and -2 satellites, EOP are sent weekly to the Central and Rapid IERS Bureaus. EOP accuracy has been improved to the level of a few millimeters. Plots are available at <http://maia.usno.navy.mil/plots.html>.

In 1996, the MCC started a regular service of assessing performance of the SLR stations. All LAGEOS-1 and -2 data are analyzed to obtain values of time and range biases and RMS. The routine service requires two levels of data filtering: automatically excluding outliers and problem sessions and manually checking and correcting the results.

### *GLONASS Orbit Determination and Verification*

The MCC has been making contributions to the International GPS Service (IGS) by providing precise orbits based on SLR observations for those GLONASS satellites that are observed by the ILRS network. These independent orbits help to validate and evaluate precise orbits computed by three other analysis centers from the IGS tracking network observations. Additional goals of this activity include:

- Estimation of the real on-board ephemeris and time performance for GLONASS systems
- Monitoring of the transformation parameters between the PZ-90/GLONASS and ITRF coordinate systems

Since 1995, the MCC has permanently supported orbit determination of GLONASS satellites based on SLR data. Orbits for GLONASS satellites (in SP3 format) are regularly sent to the CDDIS for the determination of the final orbits based mainly on the GLONASS “phase” data. Due to the limited number of measurements, the MCC currently does not determine precise GLONASS orbits based on SLR data for every day. Comments to the solutions provided to the CDDIS are also included (see the Table A-5 as an example for GLONASS-22). The information in this table for each day and satellite includes: date, number of normal points (N-P), number of passes (NPAS), station number (NST), duration of the pass (DUR), and comments (BAD, if the orbit quality is not guaranteed). Table A-5 shows that the amount of SLR data is not sufficient for routine, daily precise orbit determination of the GLONASS satellites.

**Table A-5. GLONASS-22 Overview of Number of Passes Observed by SLR Stations**

Date	N-P	NPAS	NST	DUR	GPS WK	Comments
2004.10.03	22	2	2	126	12910	
2004.10.04	11	5	3	405	12911	
2004.10.05	7	1	1	28	12912	BAD
2004.10.06	1	1	1	0	12913	BAD
2004.10.07	7	2	1	21	12914	BAD
2004.10.08	20	6	4	97	12915	
2004.10.09	9	2	2	34	12916	BAD

Figures A-10 and A-11 show SLR data statistics and the differences between the SLR and “phase” orbits for the GLONASS-03 satellite in October 2004.

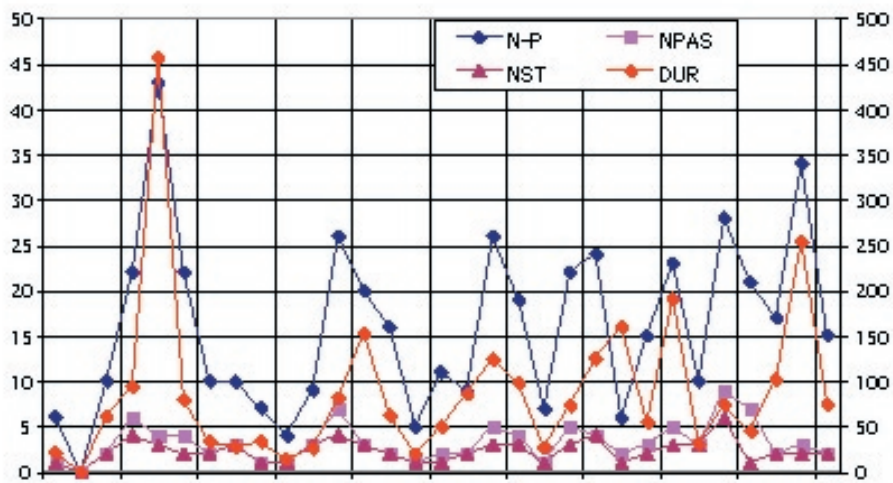

Figure A-10 SLR data statistics for GLONASS-03.

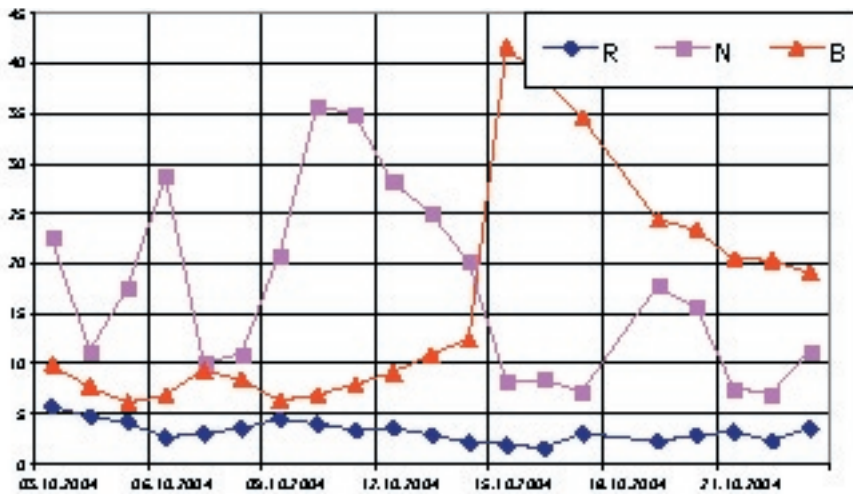

Figure A-11. RMS of the SLR and “phase” orbits differences for GLONASS-03 (R-radius direction, N-along orbit, B-across orbit).

### *Meteor-3M/SAGE-III Mission Support*

The joint U.S./Russia Meteor-3M/SAGE-III mission was launched in December 2001 and has been generating ozone, aerosol, water vapor, nitrogen dioxide, and temperature profiles needed for the international assessment of the health of the stratospheric ozone layer. Soon after launch, it was apparent that the GPS/GLONASS capabilities of the spacecraft were not functional – a serious loss hampering orbital knowledge and ability to analyze the data. Fortunately, a successful laser ranging experiment onboard the Meteor-3M satellite has been able to provide the orbital elements with a precision adequate for the goals of SAGE-III. The MCC has supported the Meteor-3M/SAGE-III mission by generating daily or weekly IRVS predictions for the SLR network and calculating precise orbits during the testing phase of the experiment.

Figure A-12 shows the deviations of the ozone profile, calculated by the CAO (Central Aerological Observatory, Russia) with the use of the standard orbits, from the ozone profile, calculated by the LaRC (NASA, USA) with the use of the orbits based on the SLR observations. Figure A-13 shows the deviations of the profiles for the same event; however, during the calculation of the profile by CAO, the results of the orbits based on the SLR observations were. It is evident that from this figure that the shift and the amplitude of deviations are significantly reduced. Furthermore, the ozone profiles results based on the SLR orbits are well coordinated with the balloon ozone sounding results achieved in the special testing local areas.

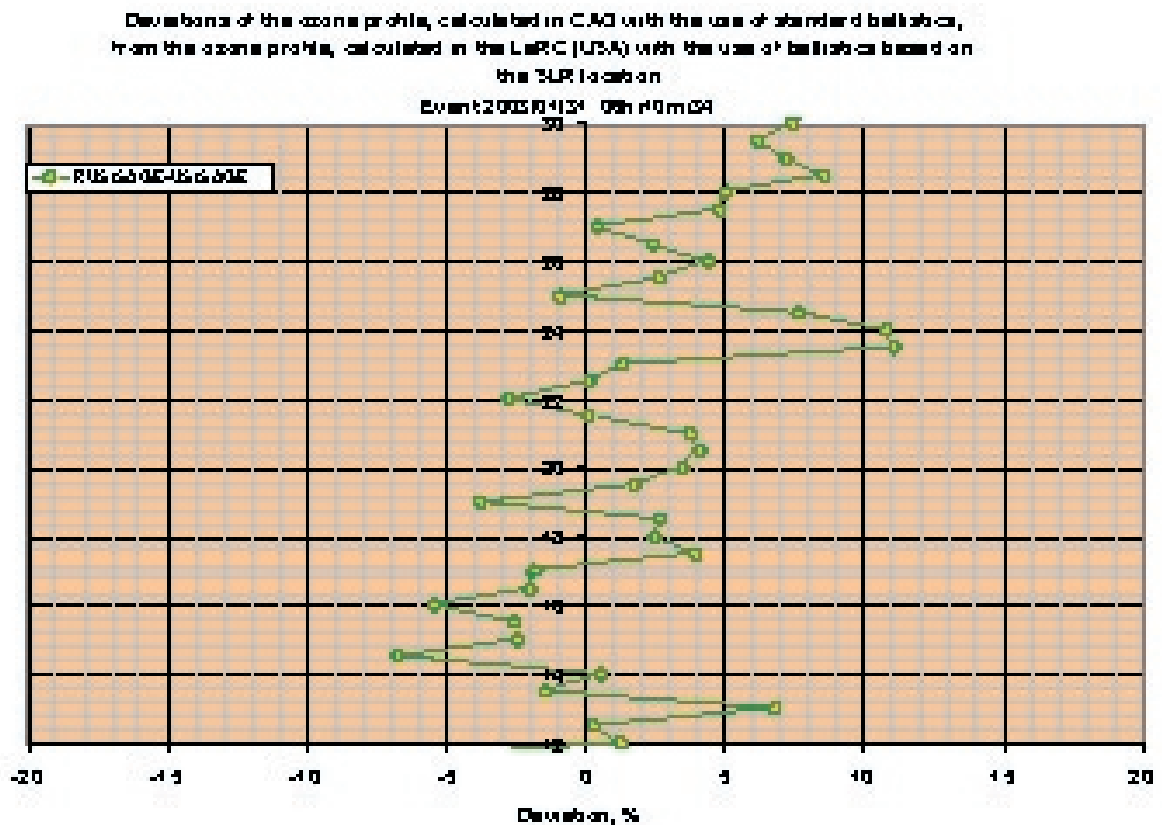

Figure A-12. Results based on standard orbits.

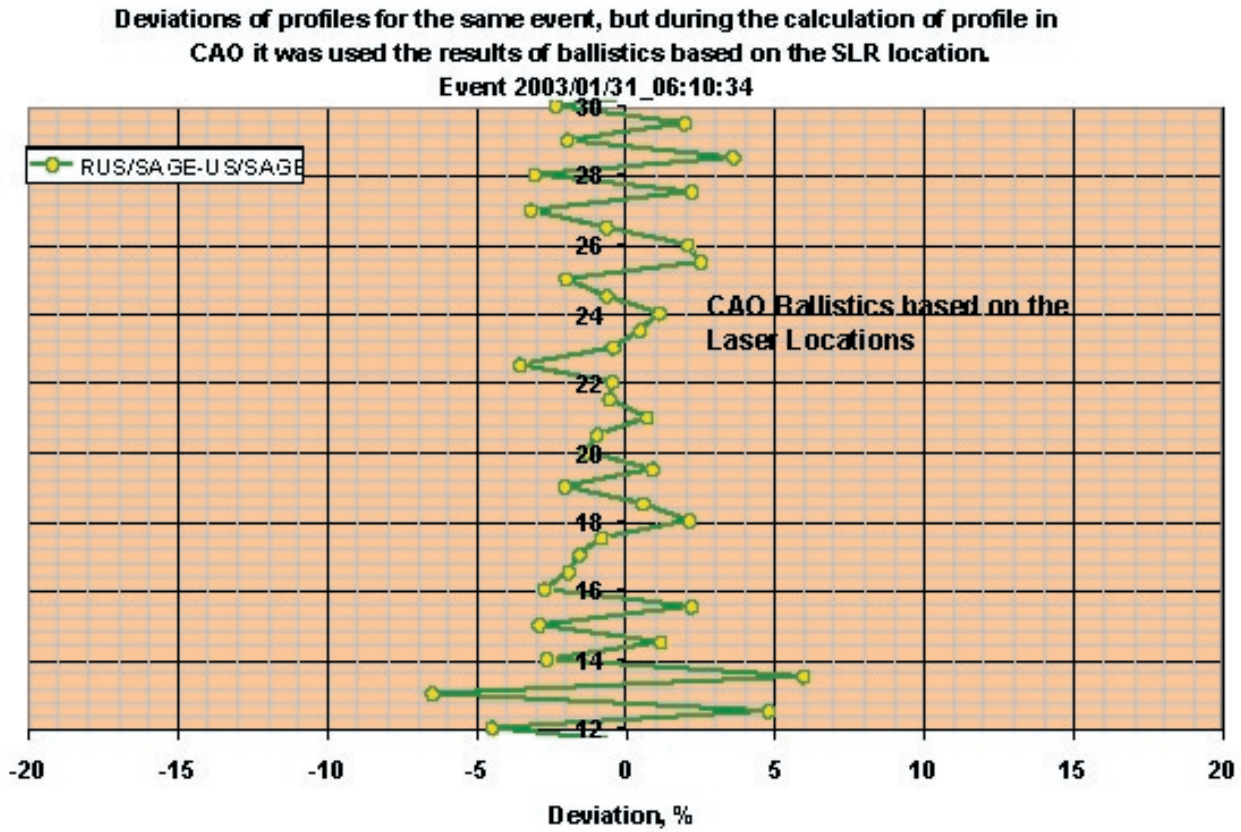

Figure A-13. Results based on SLR orbits.

## Contacts

Vladimir Glotov (coordinator)  
 Vladimir Mitrikas (main expert)  
 Sergey Revnivych (administrative support)  
 Russian Mission Control Centre (MCC)  
 4 Pionerskaya Street  
 Korolyov, Moscow Region 141070  
 RUSSIA

E-mail: [vladimir.glotov@mcc.rsa.ru](mailto:vladimir.glotov@mcc.rsa.ru)  
 E-mail: [vladimir.mitrikas@mcc.rsa.ru](mailto:vladimir.mitrikas@mcc.rsa.ru)  
 E-mail: [sergey.revnivych@mcc.rsa.ru](mailto:sergey.revnivych@mcc.rsa.ru)

## Newcastle University, UK Associate Analysis Center

*Philip Moore/Newcastle University*

The School of Civil Engineering and Geosciences (SCEG) at Newcastle University has been active in space geodetic research for over a decade. Our current ILRS associate analysis center activities include: precise orbit determination of altimetric and geodetic satellites utilizing SLR, DORIS, PRARE and altimetry in the form of single and dual satellite crossovers, calibration of radar altimeters, and the study of reference frame issues. Effort is continually devoted to development of the in-house orbit determination package Faust. The software is now able to process orbits in a reduced dynamic mode given dense global tracking such as DORIS or altimetric crossover differences. Reduced dynamic orbits utilize empirical 1 cy/rev accelerations over short time intervals with adjacent parameters constrained by the use of pseudo-observations. The methodology was applied successfully to Envisat orbits as part of our contribution to the POD Validation Team and the Radar Altimeter Cross-calibration Validation Team. Precise orbits of LAGEOS-1 and -2, Stella, Starlette, and Ajisai have been computed to infer temporal annual and semi-annual variability in the Earth's gravity field for comparison against geophysical data and early results from GRACE. Combination solutions of SLR with CHAMP, and of SLR, CHAMP and GPS have shown that the synergy of all three data types yields the highest correlations and lowest rms differences with geophysical data. The low degree and order harmonics from LAGEOS have been compared directly with the monthly GRACE solutions with good agreement in the second and third zonal harmonics and the second-degree tesseral harmonics. SCEG is an IGS Global Network Associate Analysis Center producing weekly combination station coordinates and Earth rotation parameters for the IGS network. This rigorous approach is being applied to SLR coordinates to produce solutions from the ILRS analysis and associate analysis centers.

### Contact

Philip Moore  
Department of Geomatics, Newcastle University  
Newcastle, NE43 7RU  
UK

Voice: + 44 (0)191 222 5040  
E-mail: [Philip.moore@ncl.ac.uk](mailto:Philip.moore@ncl.ac.uk)

## **National Institute of Information and Communications Technology (NICT) Associate Analysis Center**

*Toshimichi Otsubo/NICT*

On April 1, 2004, our institute, formerly Communications Research Laboratory (CRL), was reorganized into the National Institute of Information and Communications Technology (NICT). We will continue our activity as an ILRS associate analysis center.

### **Signal Detection of Atmospheric Loading Displacement**

Variation of a vertical component due to atmospheric loading effect has been researched for a couple of decades, and the amount of deformation is typically 1 cm peak-to-peak or less. The effect has already been seen in GPS and VLBI data, and we found it is also possible to detect the vertical variation as a function of atmospheric pressure from recent LAGEOS laser ranging data. Using our orbit analysis software 'concerto', a new adjusting parameter, height per pressure, was implemented. The parameter was estimated simultaneously with other parameters such as orbits and station coordinates, and we obtained -0.3 to -0.5 mm/hPa for the majority of laser ranging stations in the world. These results agreed well with the theoretical deformation computation and the detection studies by GPS and VLBI (Otsubo et al, EGU Meeting, Nice, 2004).

### **Weekly Bias Report**

Weekly reports of seven-satellite (two LAGEOS, two Etalon, Ajisai, Starlette, and Stella) residual analyses, producing pass-by-pass range bias and time bias, have been distributed to the ILRS community for five years. Some station coordinates were updated for new stations and improved stations.

The post-fit residuals were found to be correlated with the number of returns per normal point bin especially for C-SPAD systems (Otsubo and Appleby, San Fernando Workshop, 2004). The variation in range depends on the size of geodetic satellites and is originated from the satellite signature effect.

### **Development of POD Software 'concerto v4'**

We have redesigned our analysis software package 'concerto'. In its new version 4, the physical models are upgraded to be compatible with the IERS Conventions 2003. In addition, this software will be able to handle not only SLR data but also GPS-LEO SST, accelerometer, astrometry, and other data types.

### **Contact**

Toshimichi Otsubo  
NICT  
893-1 Hirai  
Kashima, Ibaraki 314-8501  
JAPAN

Voice: 81-299-84-7189  
Fax: 81-299-84-7160  
E-mail: [otsubo@nict.go.jp](mailto:otsubo@nict.go.jp)



## Natural Environment Research Council (NERC) Space Geodesy Facility (NSGF) Associate Analysis Center

*Graham Appleby, Philip Gibbs, Matthew Wilkinson/NSGF*

### Contribution to ILRS Position and Earth Orientation Operational Product

The in-house SATAN SLR processing software at Natural Environment Research Council (NERC) Space Geodesy Facility (NSGF) has now been fully automated to analyze weekly ILRS LAGEOS and Etalon tracking data. Each week on a Tuesday, observations from these four geodetic satellites are used to determine daily values of polar motion (Xpole, Ypole), length of day (LoD) and a set of station coordinates for the previous GPS week, ending at midnight on Saturday. The unconstrained solutions, in SINEX format, are uploaded for rapid processing by the Combination Centers to CDDIS and EDC as NSGF's contribution to the official ILRS position and Earth orientation product stream. Additional weekly solutions, constrained to the reference frame of ITRF2000, are also generated for internal use and quality checks. In a related study, we are developing the capability of analyzing networks of GPS data to study possible local deformation at the SGF site.

### Shadow Transitions of ILRS Satellites

The plot in Figure A-14 shows a series of photometric measurements taken at 10 ms time resolution by NSGF of Envisat as it emerged from the Earth's shadow. These observations are being used at the Department of Geomatic Engineering, University College London, as part of their development of a general-purpose non-gravitational force model, to include shadow transit effects. Both the photometric observations and a precise short-arc orbit derived from laser data are provided to UCL by NSGF.

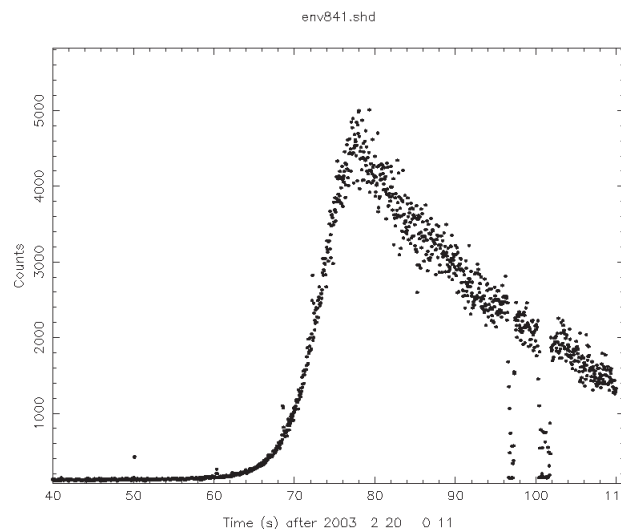

*Figure A-14. Photometric measurements of Envisat as it emerged from the Earth's shadow.*

### Daily Quality Monitor

The automatic daily web-based service continues. Long-arc (6-day) orbits are fitted to all ILRS stations' observations of the two LAGEOS and the two Etalon satellites. Observational residuals for each station from those fitted orbits are then displayed daily for the four satellites on single plots for each station. Post-fit residual mean and sigma values give an indication of the relative station bias and precision of the data for each satellite during the period, as well as showing current network productivity. In addition, for most satellites in the ILRS tracking list, short-arc solutions are carried out

for all arcs that are tracked pseudo-simultaneously by at least two stations. A new, very rapid, service has been instigated as a by-product of the NSGF/CODE time bias service, which runs at Herstmonceux on an hourly basis. Any given pass that produces an abnormal time bias relative to IRV-based predictions is flagged as suspect, and an e-mail sent to the station involved, provided that the station has joined the scheme. Some work is still to be done to reduce 'false alarms' that can occur if unscheduled satellite maneuvers are performed or if, as happened during November 2004, a severe solar storm so effects atmospheric density and perturbs a number of satellites that their predictions rapidly accumulate significant error.

## GLONASS/GPS Orbital Determination

We have continued our study to use SLR observations of the ILRS-campaign GLONASS and GPS satellites to check the quality of the available microwave-based orbital solutions. The SLR observations are used both to generate independent orbits for comparison with the microwave orbits, and in a direct comparison to the positions of the satellites given by the microwave orbits. For the GPS satellites (GPS-35 and -36) the results confirm that on average the satellites are some 40 mm closer to the Earth than is implied by the microwave-based orbits, given of course the accuracy of available data for the location of the on-board retro-reflector arrays. For the GLONASS satellites, after taking into account ranging-system dependent effects due to the large reflector arrays, we find that radial errors are on average close to zero. A clear improvement in the quality of the IGS orbits of the GLONASS satellites is apparent from about mid-2003, from which time the radial error (RMS) is approximately 10 cm, similar to that of the two GPS satellites.

## Satellite Predictions

Daily and medium-term IRVs along with hourly time bias functions are automatically generated for most of the laser-tracked satellites using up-to-date SLR data. For the designated GLONASS satellites we compute daily IRVs in collaboration with the CODE, Berne, group. All the predictions are available through EDC and on our own anonymous ftp site (*mtuftp.nmt.ac.uk*; directory *nercslr/current*), acting as a backup for the official ILRS IRVs. We recently collaborated with both the GSFC and ESOC groups in an exercise to ensure that all IRV products are tuned to the same underlying model as used by the tracking network.

## Related Publications

- Otsubo, T. and G.M. Appleby, System-dependent center-of-mass correction for spherical geodetic satellites. *J. Geophys. Res.* Vol 108, No. B4, 10.1029/2002, 17 April 2003.
- Otsubo, T, Sherwood, RA, Gibbs, P and Wood, R. Spin Motion and Orientation of LAGEOS-2 from Photometric Observation. *IEEE Transactions on Geoscience and Remote Sensing*, Vol 42, No. 1, January 2004.
- Wood, R and Appleby, GM. Satellite Laser Ranging. Chapter in *Handbook of Laser Technology and Applications*, Institute of Physics, December 2003.

## Acknowledgements

The NERC Space Geodesy Facility is funded by the UK Natural Environment Research Council in collaboration with the British National Space Centre and the Ministry of Defense.

## Contact

Graham Appleby  
ITE Monks Wood  
Abbots Ripton  
Huntingdon, Cambridgeshire PE17 2LS  
UNITED KINGDOM

Voice: 44-0-1487-772477  
Fax: 44-0-1487-773467  
E-mail: [graham.appleby@nerc.ac.uk](mailto:graham.appleby@nerc.ac.uk)

# Observatoire de la Côte d'Azur (OCA)/GEMINI Associate Analysis Center

*Pierre Exertier, David Coulot, Philippe Berio, Pascal Bonnefond, Olivier Laurain/OCA*

## Introduction

Besides its involvement in the SLR data acquisition through the operation of the Grasse stations (SLR, LLR high altitude satellites and Moon), and the FTLRS deployed in the Mediterranean area and Europe since March 2003, the OCA/GEMINI department is actively contributing to the ILRS as an associate analysis center (AAC).

We have participated in the analysis of:

- LAGEOS (-1 and -2) SLR data for carefully determining site coordinates and EOP time-series (processing method in development)
- SLR data for calibration/validation (CAL/VAL) activities (Jason-1, essentially)

## Facilities/Systems

The current computation facilities of the OCA/GEMINI consist of one dual processor Compaq (DEC-Alpha) workstation. The processing system uses the GINS (GRGS/CNES) software for orbit determination and a suite of locally developed programs for space geodetic analysis.

In collaboration with CNES (Toulouse) and IGN (Paris), our AAC is supporting three laser ranging stations (SLR, FTLRS, and LLR) and one permanent GPS receiver. In 2005, the SLR station operations will be stopped. We are currently working to improve the LLR station capabilities for low earth satellite tracking (necessitating a larger velocity capacity along the azimuth and elevation axes), and very long distance one- and two-way ranging (necessitating a better stability of the telescope).

## Background

In 2003-2004, the primary objectives (and organization) of the OCA AAC have been to prove the efficiency of space technique combinations for computation of:

- Earth Orientation Parameters (EOPs polar motion and Universal Time, every six hours)
- Terrestrial reference frames (every seven days)

The techniques used are SLR, DORIS, GPS, and VLBI and laboratories in charge of the treatment of each data set are:

- SLR: OCA AAC (D. Coulot, P. Berio, P.Exertier)
- DORIS: CNES/CLS (L. Soudarin)
- GPS: CNES/Noveltis (S. Loyer)
- VLBI: Observatoire de Paris (A.M. Gontier)

Seven-day orbits of LAGEOS-1 and -2 were computed for a complete one-year test period in 2002. On average, a weighted rms of 1.0 cm was obtained for both satellite orbits from around 1300-1400 normal points per arc.

Preliminary solutions for EOPs, obtained in 2003 from three of the four techniques, are shown in Figure A-15. Some statistics: rms  $X_p/Y_p$  (relative to IERS C04): 0.69 mas (DORIS), 0.32 mas (SLR), 0.27 mas (GPS); and rms UT (relative to IERS C04): 0.064 msec (DORIS), 0.028 msec (SLR), 0.017 msec (GPS).

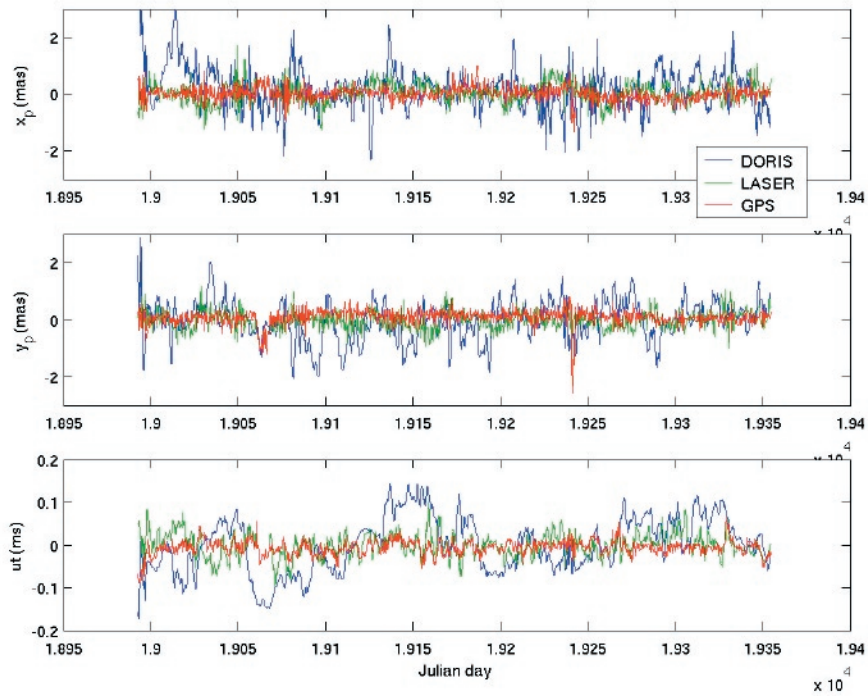

Figure A-15. Preliminary solutions for EOPs obtained with DORIS, SLR and GPS. The time-scale covers 2003 completely.

As a second example, the time-series for the coordinates solutions for the laser station in Hartebeesthoek, South Africa, is shown in Figure A-16.

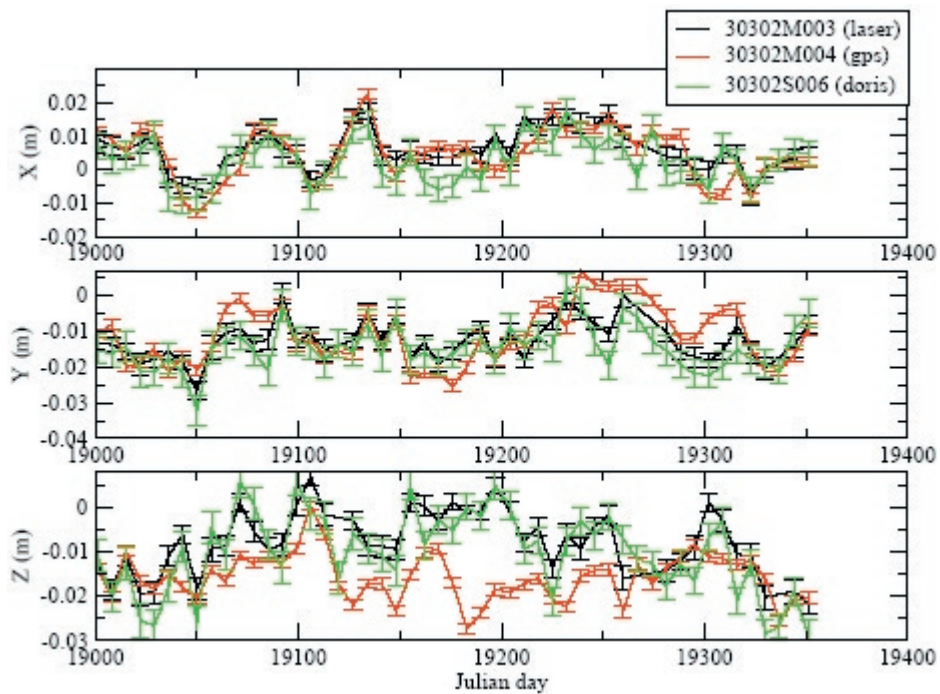

Figure A-16. Coordinates time-series for Hartebeesthoek, South Africa.

A successful test was made in June 2003 in producing normal matrices covering station coordinates and EOPs, in the SINEX format for the ILRS Analysis Working Group.

The French Transportable Laser Ranging Station (FTLRS) began observations in its new configuration in the summer of 2001. The mobile station was deployed in Corsica, for six months in 2002, at the CNES absolute calibration site (Aspretto, Ajaccio). In 2003, the station was deployed on the campus of the TUC University of Chania, Crete, for a six-month period to support the European Gavdos project. In 2004, the mobile station was deployed for two one-month occupations in San Fernando, Spain (for cross-calibration purposes with the stationary Spanish system), and in Brest, Brittany, France (for participation in a campaign to measure ocean loading effects). For more information on the French systems, see the submission to the stations section of this report.

The activities of the OCA AAC have been focused on the analysis of FTLRS and other SLR data acquired from altimeter satellites such as TOPEX/Poseidon (T/P) and Jason-1. A short-arc orbit technique for orbit validations and calibration/validation activities has been applied to the entire laser network. These developments and capabilities have been put on a dedicated Web site in order to permit the near real-time, continuous validation of altimeter satellite orbits. This site can be used to evaluate results of the overall mission, including local radial, tangential, and normal orbit residuals and SLR residuals, eventually per station (see <http://www.obs-azur.fr/cerga/gmc/calval/pod/index.htm>).

## Current Activities

The current activities of the OCA AAC are:

- Computation of purely SLR solutions for EOPs and station coordinates in addition to our participation in the 2005 IERS combined techniques preliminary campaign;
- Processing of San Fernando and Brest FTLRS tracking data; and
- Implementation of the second Jason-1 CAL/VAL campaign, which is planned in Corsica (the official site of CNES) in 2005.

## Future Plans

OCA AAC will continue its development of laser data analysis. Activities in the future will be centered on:

- Jason-1 CAL/VAL campaign(s) (realization and data processing).
- Computation of laser EOP and station coordinate time series and distribution of products to the ILRS.
- Participation with GRGS (Paris Observatory, Toulouse, and Grasse) in the IERS 2005 campaign of EOP combined solutions (GPS, SLR, DORIS, VLBI, LLR), via the production of SLR based EOP and station coordinates solutions in SINEX format.

## Related Publications

- Berio, P., D. Coulot, R. Biancale, J.-M. Lemoine, S. Loyer, L. Soudarin, P. Exertier, A.-M. Gontier, D. Gambis, N. Capitaine, and Z. Altamimi (2004) Combination of VLBI, GPS, SLR and DORIS data at the measurement level. I Earth orientation parameter computation, *Astron. & Astrophys.*, to be submitted.
- Berio, P., F. Pierron et al. (2004) FTLRS support to the GAVDOS project: tracking and positioning, *14<sup>th</sup> International Laser Ranging Workshop and International Laser Ranging Service (ILRS) General Assembly*, June 7-11, 2004, San Fernando, Cadiz, Spain.
- Bonnefond, P., P. Exertier, O. Laurain, Y. Ménard, A. Orsoni, G. Jan, and E. Jeansou (2003) Absolute Calibration of Jason-1 and TOPEX/Poseidon Altimeters in Corsica, *Marine Geodesy, Special Issue on Jason-1 Calibration/Validation*, 26(3-4), 319-334.

- Bonnefond, P., B. Haines, G. Born, P. Exertier, S. Gill, G. Jan, E. Jeansou, D.G. Kubitschek, O. Laurain, Y. Ménard, and A. Orsoni (2003) Calibrating the Jason-1 Measurement system: initial results from the Corsica and Harvest Verification Experiments, *Adv. Space Res.*, Vol. 32 (11), 2135-2140.
- Coulot, D., P. Berio, P. Exertier, and O. Laurain (2003), Times series of satellite laser ranging station positions, *Bull. SF2A*, F. Combes, D. Barret and T. Contini Ed., EDP Sciences 2003, pp. 51-54.
- Coulot, D., P. Berio and P. Exertier (2004) Time series of satellite laser ranging stations positions, *14<sup>th</sup> International Laser Ranging Workshop and International Laser Ranging Service (ILRS) General Assembly*, June 7-11, 2004, San Fernando, Cadiz, Spain.
- Coulot, D., R. Biancale, P. Berio et al. (2004) Combination of space geodesy techniques for monitoring the kinematic of the earth, *14<sup>th</sup> International Laser Ranging Workshop and International Laser Ranging Service (ILRS) General Assembly*, June 7-11, 2004, San Fernando, Cadiz, Spain.
- Exertier, P., J. Nicolas, P. Berio, D. Coulot, P. Bonnefond, and O. Laurain (2004) The Role of Laser Ranging for Calibrating Jason-1: the Corsica Tracking Campaign, *Marine Geodesy*, 27(1-2), 333-340.
- Nicolas, J., D. Coulot, O. Laurain, P. Bério, P. Bonnefond, and P. Exertier (2003), "Satellite Laser Ranging positioning time series", *Cahiers du Centre Européen de Géodynamique et de Séismologie, Proceedings of the workshop: The state of GPS vertical positioning precision: Separation of earth processes by space geodesy*, Ed. T. van Dam, Vol. 23, in press.

## Contact

Dr. Pierre Exertier  
OCA/GEMINI  
Avenue Nicolas Copernic  
06130 Grasse  
FRANCE

Voice: +33-(0)4 39 40 53 82  
Fax: +33-(0)4 93 40 53 33  
E-mail: Pierre.Exertier@obs-azur.fr

## Paris Observatory Lunar Analysis Center (POLAC)

*Jean Chapront, Michelle Chapront-Touzé, Gérard Francou/Paris Observatory*

The Paris Observatory Lunar Analysis Center (POLAC) is located in the laboratory “Systèmes de Référence Temps-Espace” (SYRTE) at the Paris Observatory. The group works in cooperation with the LLR staff at the Observatoire de la Côte d’Azur (OCA, Grasse, France) and with the IERS teams EOP-PC and ICRS-PC based at the Paris Observatory. LLR analysis allows us to improve our knowledge of the dynamics of Earth-Moon system and, more generally, to determine the parameters with sensible signatures in the lunar motions. In late 2004, our team will change: J. Chapront will retire and M. Chapront will move to new activities; a new collaborator should join our group in the near future. In the meantime, the current LLR analysis will continue.

In 2003, the main effort of the center was the construction of a new lunar solution. This solution is built upon the latest versions of the semi-analytical ELP solutions and uses the planetary perturbations (MPP01) constructed recently by Bidart (2001). This new solution, called ELP/MPP02 has been compared with the JPL ephemerides DE405/DE406 for testing its accuracy over short and long time periods. On the time interval of one century centered around J2000, we added to ELP/MPP02 numerical complements  $\rho 405$  based on the differences with DE405. In such a way, ELP/MPP02+ $\rho 405$  keeps the high precision of DE405 and, with its analytical formulation, it can be directly fitted to the LLR observations provided by the stations OCA and McDonald Observatory (Texas, USA) since 1970.

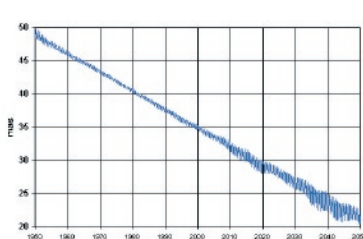

Figure A-17. Longitude

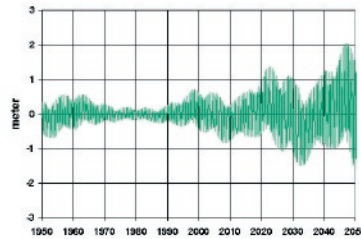

Figure A-18. Latitude

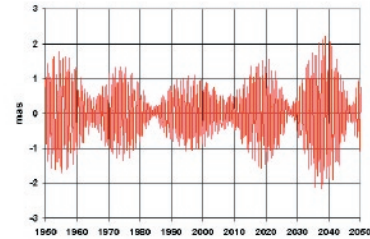

Figure A-19. Distance

Figures A-17 – A-19 show the differences between DE405 and ELP/MPP02+ $\rho 405$  fitted to LLR observations for the three coordinates over the period 1950-2050. The offset and the slope in longitude correspond to a difference between the reference frames and the mean longitude constants. The discrepancies in distance are as large as 30 cm in the mid LLR period. A large part of these differences arises from the models and various parameters (lunar and solar parameters, libration, stations and reflectors positions, etc.). Globally the post-fit residuals obtained with the ELP/MPP02[LLR] model are within 3 to 2 centimeters in the distance ‘station-reflector’ for recent observations.

### References

- Bidart, P., 2001, *Astron. Astrophys.*, 366, 351.  
 Chapront, J., M. Chapront-Touzé, G. Francou, 2002, *Astron. Astrophys.* 387, 700.  
 Chapront, J., M. Chapront-Touzé, G. Francou, 2003, *Astron. Astrophys.* 404, 735.

### Contacts

Jean Chapront  
 Michelle Chapront-Touzé  
 Gérard Francou  
 Observatoire de Paris (SYRTE)  
 61 avenue de l’Observatoire  
 75014 Paris, FRANCE

E-mail: [jean.chapront@obspm.fr](mailto:jean.chapront@obspm.fr)  
 Web: <http://syrte.obspm.fr/polac>





---

# APPENDIX B

## STATION REPORTS



FRASER PRINCIPALS





# APPENDIX B

---

## ILRS STATION REPORTS

### **Arequipa, Peru**

*Julie Horvath/HTSI*

TLRS-3, shown in Figure B-1, supplied SLR tracking from Arequipa, Peru for the 13<sup>th</sup> year at this location in the year 2003.



*Figure B-1. The TLRS-3 system in Arequipa, Peru.*

The TLRS-3 SLR tracking coverage decreased slightly in 2003 due to several engineering issues. TLRS-3 logged almost 10,000 (10,595 in 2002) minutes and contributed over 24,000 normal points to the scientific user community. Although the system continued to capture, produce and deliver high quality LAGEOS data, the average single shot RMS was slightly degraded due to mount pointing issues that plagued the system throughout the year. As always, TLRS-3 provided outstanding tracking coverage of LEO satellites, collecting over 22,000 normal points for these satellites in 2003.

Due to severe funding issues in the NASA budget, NASA was forced to close the TLRS-3 system in early 2004. The lack of data from this location has been greatly missed in the ILRS solutions. NASA is interested in the possibility of reopening the TLRS-3 system in early 2005.

### **Contact**

David Carter  
NASA GSFC  
Code 453  
Greenbelt, MD 20771  
USA

Voice: 301-614-5966  
Fax: 301-286-0328  
E-mail: [David.L.Carter@nasa.gov](mailto:David.L.Carter@nasa.gov)

## Beijing, China

*Feng Qu, Tanqiang Wang/CASM*

### New SLR System for Argentina

The most important event in the years 2003-2004 at the Beijing station was the completion of the new SLR system for Argentina. The SLR system was completely developed, checked and accepted on January 12, 2004 by the sponsor, the Ministry of Science and Technology of China. The project to build a new SLR station in San Juan, Argentina is a cooperative venture between the University of San Juan, Argentina and National Astronomical Observatories (NAO), and the Chinese Academy of Sciences. The system was designed and developed by the Beijing SLR station, Chinese Academy of Surveying and Mapping (CASM) in the years of 2000 to 2004. The new station will be installed at the San Juan Astronomical Observatories, University of San Juan, Argentina in 2005.

The alt-azimuth mount is the most convenient configuration for satellite tracking especially for low satellites, including their observations near zenith. The initial alt-azimuth telescope mount was the same as the one at the Beijing SLR station but many improvements were made through the efforts of the staffs of the Shanghai and Beijing station and the NAO. The hardware and software for the controller and servo systems benefited from the involvement of the Wuhan station staff. The precision was verified from the data analysis reports of Delft University in the year 2003. The work of packaging and shipment began in October 10, 2004 and is progressing.

The system configuration is as following:

- Reflecting telescope: bi-axes; sender and receiver separated
- Control system: only by mouse; tracking, predictions, preprocessing
- Servo system: Bi-close-loop control for velocity and position
- Laser system: Nd:YAG passive mod-locked
- Receiver: C-SPAD
- Counter: SR-620
- TV system: intensifier + CCD
- Timing and frequency: HP58503A GPS time and frequency receiver
- Calibration: short distance target, out-install, inside the dome

### Rebuild of the Optical Receiving System

For a long period the Beijing SLR system had a low sensitivity and it was difficult to get returns from high satellites, even LAGEOS. In order to change the situation the optical receiving system of the Beijing station was rebuilt from September to December 2003. The results of this effort are significant and the return rate for LAGEOS was enhanced ten-fold.

- The optical receiving system for SLR Beijing has a microcrystalline glass main mirror (weight 80kg) with the diameter of 630 mm and a microcrystalline glass secondary mirror with the diameter of 200 mm. The main mirror and the secondary mirror were recoated with multilayer medium velum.
- The main mirror and the secondary mirror were re-installed and re-adjusted in mid-December by the station staff.
- There are also a spectroscope, an adjustable set of pinholes, an autocollimator, and a broadband filter of 10 nm in the optical receiving system. The optical receiving system is able to receive both visible light with an ICCD and green laser for the ranging detector without any additional adjustment of the spectroscope. These parts were also re-adjusted in December 2003.

## Operation

From January to August 2003 the Beijing station acquired more than 1500 passes. From January through October 2004 more than 2000 passes were acquired including more than 400 LAGEOS passes and more than 100 high satellite passes. This tracking quantity is unparalleled in the station's history.



*Figure B-2. Beijing SLR station. The dome in the distance is the Beijing SLR station; the low building in the foreground is the SLR system for Argentina.*

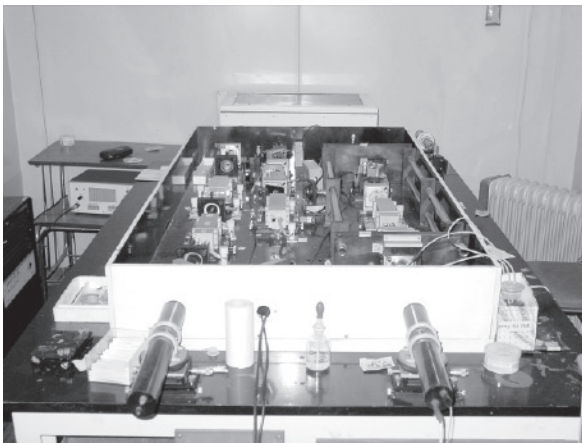

*Figure B-3. Beijing SLR laser.*

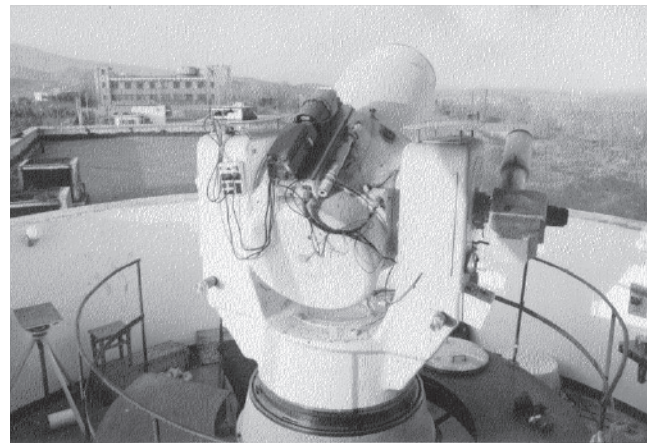

*Figure B-4. Beijing SLR telescope.*

## Contact

Prof. Qu Feng  
Beijing Station  
Chinese Academy of Surveying and Mapping (CASM)  
16 Beitaping Road  
100039 Beijing  
CHINA

Voice: +0086-10-88217725  
Fax: +0086-10-68218654  
E-mail: [qufeng@casm.ac.cn](mailto:qufeng@casm.ac.cn)

## Borowiec, Poland

*Stanislaw Schillak/Space Research Center, Polish Academy of Sciences*

The Borowiec SLR station operated continuously during the years 2003 and 2004 without major failures. We acquired 1,983 passes and 34,324 normal points during the period through October 2004. The number of passes was strongly limited by weather conditions (69% clouds) and nighttime operations only. The year 2003 proved to be the most successful year in quantity and quality of the data in the 17 years of continuous activity at the Borowiec SLR station. Since 2003, we have withdrawn from high-satellites ranging due to very low efficiency and the small number of successful passes on these satellites. Systematic high clouds and a wide laser beam strongly limited high-satellite opportunities.

In 2002-2003, several new devices were installed in the system including a Stanford SR620 interval counter, a fast start photodiode, and constant fraction discriminators Tennelec TC-454 in the start and stop channels. The system upgrades consisted of several steps: installation and examination of the new counter, including comparison tests at Herstmonceux; (March-December 2002) correction of the amplitude and shape of laser pulse with a fast photodiode (November 2002); regulation of discriminator delay and levels for the start (November 2002) and stop (January-March 2003) channels. As a result, the precision and accuracy of measurements improved by nearly a factor of two. The single shot precision, normal point precision and accuracy were improved from 30 mm to 18 mm, 7 mm to 4 mm, and 18 mm to 10 mm respectively. A two-centimeter systematic error of the Stanford time interval counter was eliminated in December 2002 using the calibrations from the Herstmonceux tests. The calibration system was upgraded in October 2002 with the installation of a neutral density filter wheel for better control of the return signal strength. The improvement in system delay stability due to variations in the stop signal amplitude was observed. The accuracy of the SLR data obtained from the results of several orbital analysis centers confirmed the improvement of the quality of the satellite laser ranging system in Borowiec.



*Figure B-5. The Borowiec SLR staff (left to right): Stanislaw Schillak, Pawel Lejba, Danuta Schillak, Jacek Bartoszak, Stanislaw Zapasnik, Piotr Michalek, Daniel Kucharski.*



*Figure B-6. The Borowiec SLR mount.*

Crewmember Tomasz Celka left the Borowiec SLR team in March 2004. In May 2004, Piotr Michalek joined the staff. Since October 2003, two postgraduates have supported the Borowiec SLR team: Daniel Kucharski (SLR system) and Pawel Lejba (orbital analysis).

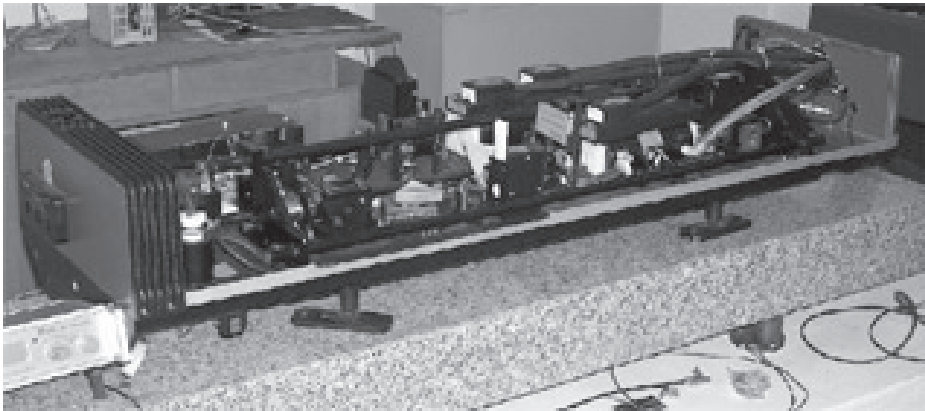

Figure B-7. The ND:YAG laser.



Figure B-8. The operations room.

The on site orbital analysis of SLR data with the NASA GEODYN-II program continues. In addition to the SLR system operation, the Borowiec site is a permanent IGS station (BOR1) operating a Turbo ROGUE SNR 8000 receiver, an IGLOS station (BORG) using a continuously operating 3S Navigation GPS/GLONASS receiver, and high-quality time service equipped with a cesium frequency standard HP-5071A and a two nanosecond Time Transfer System TTS-2.

## Contact

Stanislaw Schillak  
Space Research Center of the Polish Academy of Sciences  
Astrogeodynamic Observatory  
Borowiec  
ul. Drapalka 4  
62-035 Kornik  
POLAND

Voice: +48-61-8170-187  
Fax: +48-61-8170-219  
E-mail: [sch@cbk.poznan.pl](mailto:sch@cbk.poznan.pl)

## Changchun, China

*You Zhao/National Astronomical Observatories, Changchun Observatory, CAS*

This update on the Changchun SLR station (shown in Figure B-9) will concentrate on efforts made during the last two years to achieve daylight tracking capabilities. Daylight tracking is necessary and the goal of any SLR station. Many stations in the world can acquire daylight observations. There are also many advantages to daylight tracking, such as increasing the number of passes and observations, improving orbital coverage, and improving the ability to find systematic errors in products. During the past several years, much improvement has been made to the Changchun SLR system, including some effort for daylight tracking. However, additional improvements are still required for daylight tracking, including better telescope pointing, a better mount model for the telescope, better separation of emitting and receiving paths of the telescope, a narrower control range gate, a narrower filter in the telescope, and a detector on the front of telescope, etc.



*Figure B-9. Changchun Observatory buildings.*

Despite these many difficulties, we have done some work to try to achieve daylight tracking, include improvements in the system stability, laser stability, mount model, control system, etc. In order to improve the system stability, a new control system has been adopted, including an industrial control computer, data collecting board, and counter card for the timing and range gate. Control and data preprocessing software have also been updated so that all work can be performed automatically. For laser stability, the room is now air-conditioned. The cooling system was also improved for reliable operation, including some system protection. In order to improve the pointing accuracy, a mount model correction has been adopted in the satellite prediction. A spherical harmonics-pointing model, formulated by using astronomical observations from our telescope system, has proved to be very effective. The model makes the pointing bias very small in most positions. However, the results have not been adequate for daylight observations. Efforts will continue.

### Contact

Zhao You  
Changchun Observatory  
Jingyue Lake  
Changchun  
Jilin 130117  
CHINA

Voice: 86-431-4517112  
Fax: 86-431-4513550  
E-mail: youzhao@public.cc.jl.cn



## Concepción, Argentina

*Stefan Riepl/BKG*

After setting up the TIGO SLR station in Concepción during 2002, the designated staff continued the operation throughout 2003 and 2004 covering a 1 shift operation for seven days a week.



*Figure. B-10. Currently the staff consists of the members Cesar Guaitiau, David Ramirez, Raul Escobar, Stefan Riepl and the operators Carlos Bustamante, Marcos Avendano, Jorge Avilla, giving a total manpower of 160 hours/week for observing and system maintenance.*

Within 2003 and 2004 the SLR system was upgraded substantially improving the operation stability:

- The regenerative amplifier was equipped with a twin peak pockel cell to achieve a higher contrast ratio.
- The oscillator was upgraded with an active length control for stable generation of seed pulses.
- The former installed avalanche diode start detector was replaced by a PIN diode minimizing the jitter incurred by the start detection.
- To improve the daylight observing capabilities new spectral filters have been installed in both wavelength channels, which provide bandwidths of 0.03nm at 423.5nm and 0.05nm at 847nm respectively.
- A new HTSI Radar System for laser hazard reduction purposes was installed.
- Several capabilities and features were added to the control system software:
  - automatic database update with prediction exploder transmitted IRVs;
  - automatic full-rate data submission;
  - automatic normal point formulation; and
  - integration of the laser hazard reduction system.

### Contact

Stefan Riepl  
 Bundesamt für Kartographie und Geodäsie  
 Observatorio Geodetico TIGO  
 Universidad de Concepcion  
 Concepcion  
 CHILE

Voice: +56 41 207034  
 Fax: +56 41 207031  
 E-mail: [riepl@wettzell.ifag.de](mailto:riepl@wettzell.ifag.de)

## Grasse and FTLRS

Francis Pierron/OCA

### Grasse LLR Station 7845 (MeO)

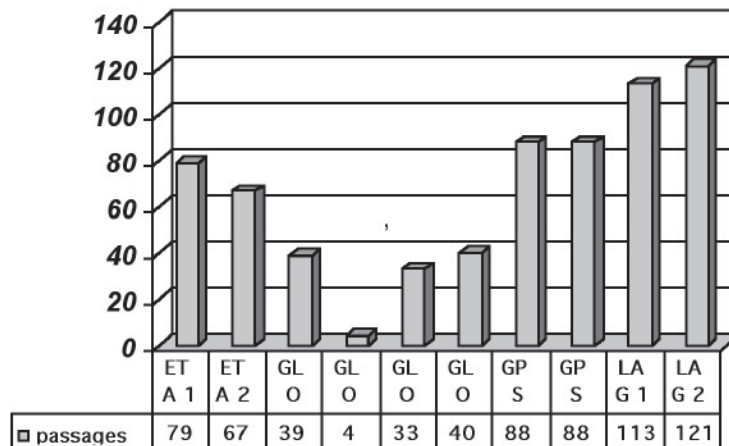

Figure B-11. The OCA laser station.

The OCA station (shown in Figure B-11) performed very well in 2003 and 2004 with more than 510 normal points on the Moon during this time period. The validated OCA LLR data are available through both the ILRS data centers and the local OCA Web site which is updated monthly. The Paris Observatory lunar analysis group continuously processes these data for Earth rotation, reference frame, and studies in the dynamics of the Moon.

During the past two years, many observations have also been achieved on higher altitude satellites (LAGEOS, GPS, GLONASS and Etalon). More than 831 passes were obtained in 2003-2004 in spite of very important technical issues for the station (see Figures B-12 and B-13).

**MeO - Grasse HEO satellites pass number in 2003**



**total 672**

Figure B-12. Grasse tracking of lunar reflectors

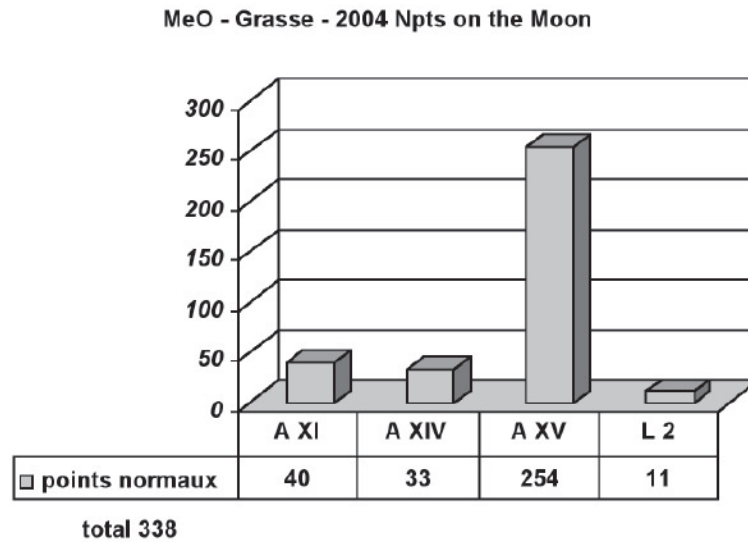

Figure B-13. Grasse satellite pass totals for 2003.

## Lunokhod1 Campaign (March-June 2004)

The Lunokhod1 retroreflector, left on the Moon by the LUNA17 mission, is not utilized in ILRS tracking at the present time. One goal of the improvements to the MeO system was to be in the best conditions to try to acquire data on this target. Due to the silver coating, this target loses half of its efficiency twelve hours after sunrise. The best ranging period is when the Moon is high in the sky and when the reflector is in darkness. This favourable period begins in January and ends in June. The observations were taken over six days, from four days after the new Moon to two days after the quarter. The tracking difficulties experienced are due to the incomplete knowledge of the reflector position. Tracking attempts were made during three lunar days from March to the end of May. Unfortunately, good weather conditions were not present during this period. Therefore, we plan to try this experiment again for some months starting in December 2004.

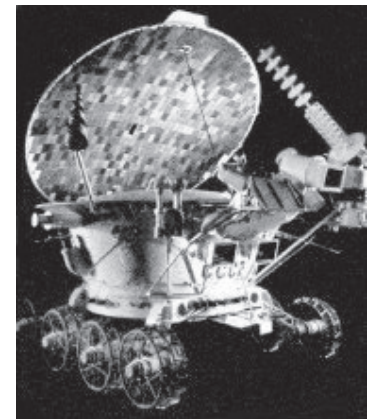

Figure B-14. Lunokhod 1 lunar rover.

## Grasse Ultra Mobile Station (FTLRS)

During 2003 and 2004, the French mobile transportable system underwent extensive operational activities in the Mediterranean area (Crete and Spain) as well as in French Normandy (Brest).

### *Gavdos Tracking Campaign in Crete (April-October 2003)*

Within the framework of a European and multi-agencies project, we have set up a semi-permanent site in Crete at the Technical University of Chania with the lowest possible installation and monitoring costs. The ultra-mobile FTLRS (French Transportable Laser Ranging Station, weight 300 kg) system was deployed there during the period from March to November 2003.

The FTLRS also tracked satellite passes for roughly six months, in particular, tracking both ascending and descending Jason-1 passes, over the Gavdos island. Our team in Chania (two staff members for six months) contributed to observation measurements and performed system adjustments and maintenance of optics, laser, telescope, etc.

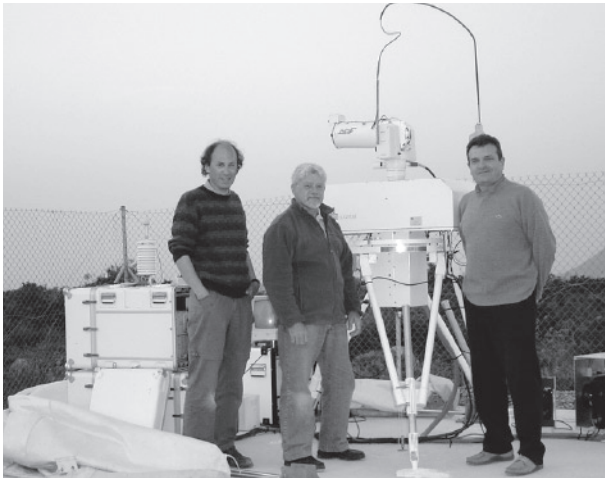

Figure B-15. FTLRS and crew in Crete.

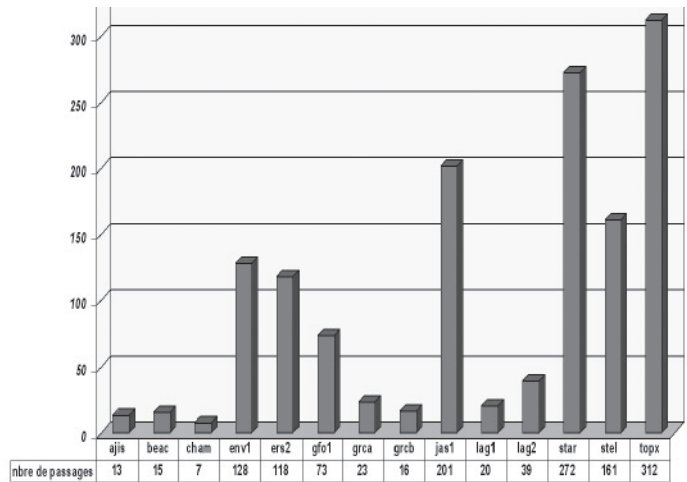

Figure B-16. FTLRS observations in Crete.

## Results

FTLRS observations in Crete included more than 1400 passes, particularly LAGEOS and with higher priorities on Jason-1 and TOPEX. The accuracy of the positioning finally obtained in the solutions was at millimeter levels. Data analysis was performed at OCA-CERGA, including accurate positioning and short arc cal/val processing for Jason-1 and TOPEX above the Gavdos island calibration point. OCA-CERGA also performs GPS treatment and comparison.

### Colocation Tracking Campaign in San Fernando, June 2004

In June 2004, we installed the FTLRS for a one-month campaign to achieve a collocation experiment with the permanent SLR station in San Fernando/Spain. With the collaboration of our Spanish colleagues, who made us very welcome in their observatory, the setup of the station was achieved in three days. We obtained the first pass on the evening of June 7<sup>th</sup>, the first day of the 14<sup>th</sup> International Workshop on Laser Ranging held in San Fernando.

On Tuesday June 8<sup>th</sup>, during a reception in the Observatory, all the participants had the opportunity to visit the system and observe satellite tracking operations with the two stations in collocation at some hundred meters apart. The staff greatly enjoyed welcoming the workshop attendees to view FTLRS in operation. The result of the collocation experiment includes over 200 passes observed by both stations; analysis is currently underway by the Grasse group.



Figure B-17. FTLRS in San Fernando.

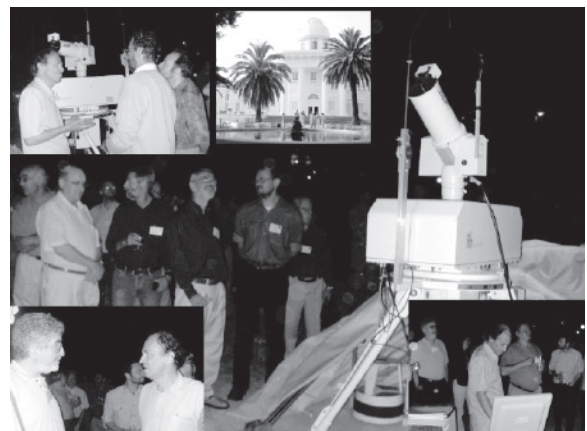
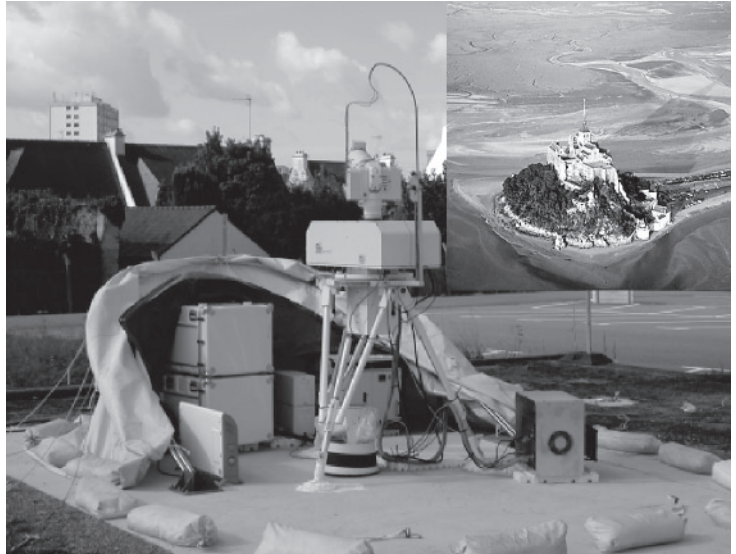

Figure B-18. FTLRS viewing at workshop.

### ***Tiding loading effects measurements in French Normandy (Brest), Sept/Oct 2004***

In the framework of a multi-techniques project to measure loading effects of equinox ocean tides on Earth's crust, we deployed the FTLRS in Brest, France for a two-month campaign. Despite poor meteorological conditions (very cloudy sky conditions which fortunately changed quickly), we obtained more than 200 passes, with a high priority on Jason-1, Starlette, Stella, and LAGEOS.

The station has worked very efficiently without any technical problems. Data were delivered to the ILRS data centers in the normal fashion. The scientific work with intercomparisons between SLR, GPS, gravimeter and tide gauges is in progress.



*Figure B-19. FTLRS occupation of Brest, France.*

### **Future Plans**

Operations at the fixed SLR station (7835) will be stopped definitively in 2005. The FTLRS will be installed in a new laboratory on the site of the old SLR fixed station and will be used alternatively for:

- international campaigns (two to six months) at locations required for scientific projects
- developments, upgrade, and operations at the Grasse observatory

The current LLR station (7845) will be completely renovated (higher tracking speeds and improved pointing precision for the telescope) via R&D studies, to permit:

- observing Earth satellites from 800 km to 36,000 km (two-way);
- observing Moon reflectors (two-way, with higher laser energy);
- observing planetary vehicles (one-way, equipped with detectors and clocks);
- making calibration of time transfer techniques based on micro-wave systems; and
- making R&D studies such as two-color laser, optics, etc.

The name of this station will be MeO (“Optical metrology” in the French language). As a consequence, the quantity of SLR data from the Grasse site will decrease during the 2005/2006 time frame and several months of system outages may occur during this timeframe.

### **Contact**

Francis Pierron  
Observatoire de la côte d’Azur, CNES/GRGS  
Avenue N. Copernic  
06130 Grasse  
FRANCE

Voice: 33 493405420  
Fax: 33 493092614  
E-mail: francis.pierron@obs-azur.fr

## Graz, Austria

Georg Kirchner, Franz Koidl/Austrian Academy of Science

### The New kHz SLR System in Graz

As described at the last laser ranging workshop in San Fernando in June 2004 (1), and during the kHz Meeting in Graz at end of October 2004 (2), our kHz SLR system has been fully operational since October 2003. Since then, we have optimized most parts of the system. As a result of this ongoing effort, the average number of returns on LAGEOS-1 is now (since August 2004) more than 10,000 points/NP. The “biggest” NP on LAGEOS-1 has more than 100,000 returns, and the largest number of returns on a LAGEOS-1 pass is more than one million returns.

For lower satellites, the difference between the 2 kHz results of Graz and the 10 Hz SLR stations is even higher, as we now get almost 100% returns from Envisat, ERS-2, and similar satellites.

The high repetition rate laser is very effective on high orbiting satellites, like GPS-35 and GPS-36. In spite of the distance and small retro panels on these satellites, and the 400 μJ/pulse of our kHz laser, we range to GPS-35/-36 in day and night, and we get more returns per NP than any other SLR station (Figure B-20).

### GPS 35: Average # of Pts/NP in 2004

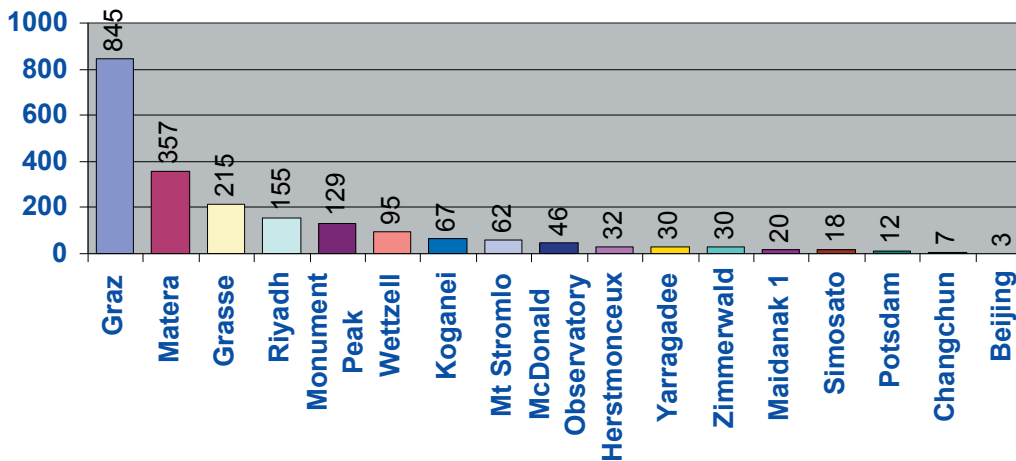

Figure B-20. Points per NP for GPS-35, from 2004-08 to 2004-10.

The short (10 ps) and weak, but uniform pulses of the kHz DPSSL (Diode Pumped Solid State Laser) have additional advantages; the single shot accuracy is now less than 2.5 mm for satellites without satellite signatures and certain minimum received energy to minimize C-SPAD jitter (like GRACE-A/B, CHAMP, etc.). As an example, the RMS of GRACE-A and its improvement of RMS during 2004 is shown in Figure B-21.

### GraceA 2004: Single Shot RMS [mm]

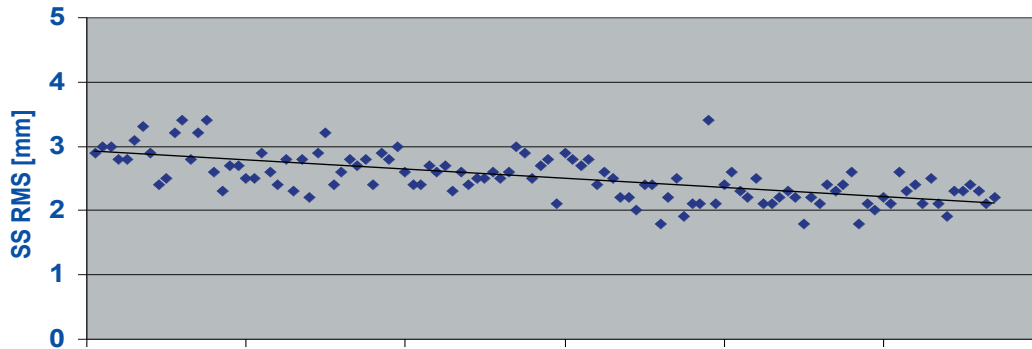

Figure B-21. Single Shot RMS of GRACE-A is now less than 2.5 mm.

This increase in accuracy and number of points per normal point results in a much better definition of these NPs, with theoretical accuracy far below the 1-mm level. This allows us to apply statistics in each NP bin, defining, for example, mean reflection points and center-of-mass (CoM) corrections for each bin, which is especially useful for satellites with significant signatures, like LAGEOS.

### Detecting Single Retroreflectors

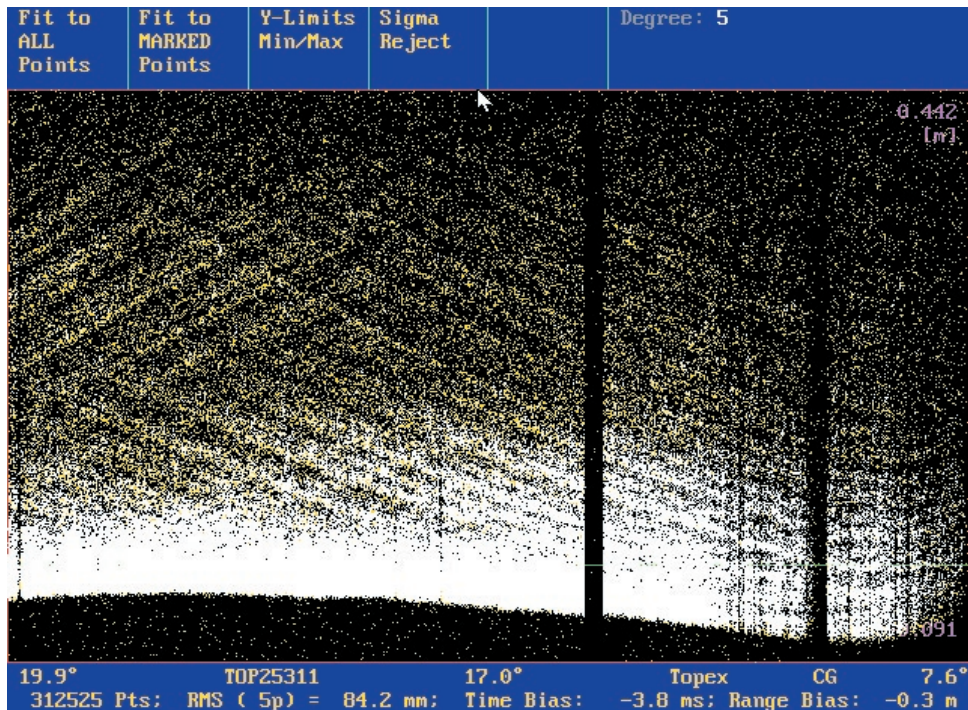

Figure B-22. TOPEX shows multiple retros.

Due to the short (10 ps) and very uniform laser pulses of the DPSSL, we now can identify single retro reflectors for many satellites. Those satellites designed specifically with only one retro being active at any time (like CHAMP, GRACE-A/B, or the Russian Larets,) do not show this effect.

As an example of such single retro detection, Figure B-22 shows the results of a typical TOPEX pass, with more than 300,000 points. The various retros of the TOPEX retro ring can be identified easily. During post-processing, only returns from the nearest retro are accepted and used to build NPs.

LAGEOS -1 also shows single retro tracks indicating that its rotation has more or less stopped now, allowing us, at least in some passes, to see the various groups of retros (Figure B-23); LAGEOS-2 (launched 1992) does not show such signatures, indicating that it is still rotating.

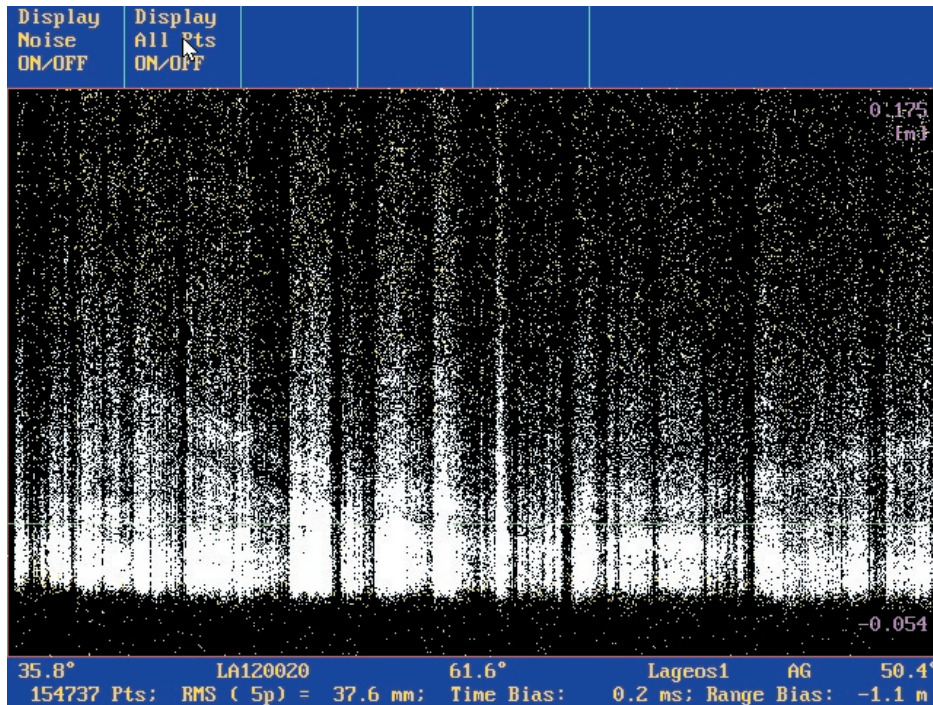

Figure B-23. LAGEOS-1 retros are clearly visible.

Single retro reflections have now been detected in Graz for ERS-2, Envisat, Starlette, Stella, GFO and other satellites; more of these pictures can be seen on our kHz meeting home page (2). Our conclusion: “There is no reason why to wait – increase your repetition rate J”.

## References

- 1) <http://www.roa.es/14workshop-laser>
- 2) <http://khzslr.oeaw.ac.at/presentations.htm>

## Contact

Dr. Georg Kirchner  
 Austrian Academy of Sciences  
 Department of Satellite Geodesy  
 Lustbuhelstrasse 46  
 A-8042 Graz  
 AUSTRIA

Phone: 43-316-873-4651  
 Fax: 43-316-873-4641  
 E-mail: kirchner@flubpc04.tu-graz.ac.at



## Greenbelt, MD

*Julie Horvath/HTSI*

MOBLAS-7, shown in Figure B-24, provided satellite laser ranging capability on a 24 hour, 7-day per week basis at the Greenbelt, Maryland location for the 22<sup>nd</sup> year in 2003.



*Figure B-24. MOBLAS-7 in Greenbelt, MD.*

In 2003, the MOBLAS-7 system was again among the global SLR system leaders in both SLR data productivity and data quality. Data volume slightly decreased this year due to weather and engineering testing issues. MOBLAS-7 still collected, produced and delivered over 92,000 normal points to the scientific user community. As MOBLAS-7 is the engineering standard for the NASA network, much station time was utilized to work on the aging receive system throughout the year. These upgrades were introduced to many of the MOBLAS systems during 2003.

MOBLAS-7 was also affected by NASA's budgetary reductions introduced in early 2004. The system's operating schedule was reduced to 1 shift, 5 days per week. This greatly reduced MOBLAS-7's contribution to the ILRS, with just over 45,000 normal points delivered to the scientific community in 2004. This data quantity reduction, however, did not affect the system's data quality. MOBLAS-7 is still among the SLR leaders in data quality with an average single shot RMS close to 1 cm.

The station manager at MOBLAS-7 in Greenbelt is Maceo Blount.

### Contact

Scott Wetzel  
Honeywell Technology Solutions, Inc. (HTSI)  
7515 Mission Drive  
Lanham, MD 20706  
USA

Voice: 301-805-3987  
Fax: 301-805-3974  
E-mail: [Scott.Wetzel@honeywell-tsi.com](mailto:Scott.Wetzel@honeywell-tsi.com)

## Haleakala (HOLLAS), HI, USA

*Dan O’Gara/ U. of Hawaii*

With the 1999-2004 SLR contract coming to an end in May 2004, and with our NASA funding modified to support a single ranging shift, the University of Hawaii decided in late 2003 to not continue SLR at Mt. Haleakala. The LURE observatory site will be used by the Institute for Astronomy to house a telescope that is part of the Pan-STARRS project, a new technology sky survey system.

The following paragraphs describe the work done at HOLLAS from January 2003 through the end of contract in June 2004.

In 2003 and 2004, HOLLAS continued making improvements and refinements to the new tracking software, the FAA radar software, and the procedures for calibration and system tuning. A measure of the improvements can be seen in the calibration results for 2004 and 2003 when compared to 2002. The mean calibration RMS improved from 4.66 mm in 2002 to 4.45 mm in 2003 with the standard deviation of this measurement falling from 0.78 mm to 0.49 mm. For the 6 months of operations in 2004, the calibration mean RMS improved even further to 4.25 mm with a standard deviation of just 0.33 mm. The graphic below in Figure B-25 illustrates this improvement in calibration RMS and measurement stability.

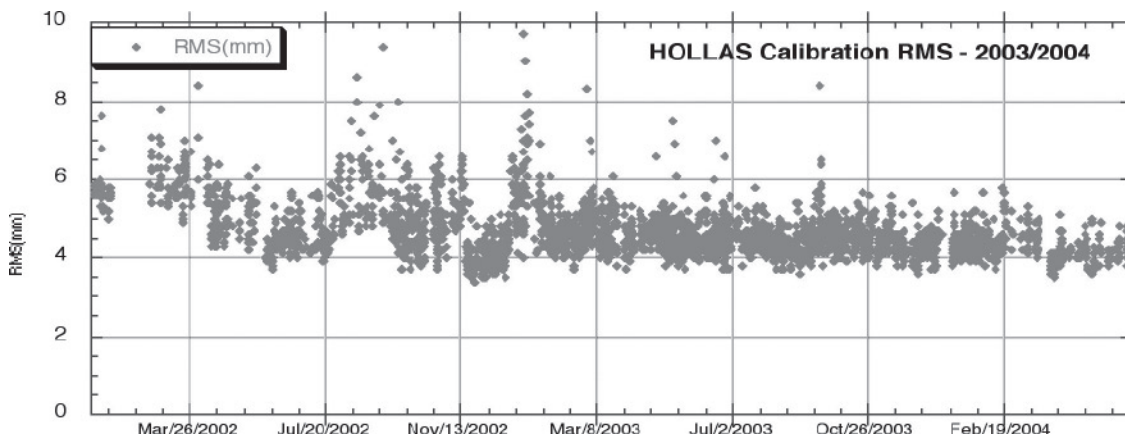

*Figure B-25. Improvement in calibration RMS and measurement stability at HOLLAS in 2004.*

The goal of single operator ranging was achieved in December 2003. Improvements to the Boeing FAA radar aircraft detection system enabled HOLLAS to safely operate SLR tracking missions without the need for a LRSO (Laser Range Safety Officer). The FAA radar system combines real time data from multiple FAA radars and transponders and displays aircraft locations relative to HOLLAS on a PC screen. Software to calculate the positions of the aircraft relative to the laser path was developed by HOLLAS personnel and integrated into the Boeing system. This final addition provided the alarm capability needed to make an outside observer redundant.

The number of passes tracked per year during this period surpassed the record number achieved by HOLLAS in 1995. The total number of passes tracked increased from 3,203 in 2002 to 5,526 in 2003. The previous record number of passes tracked in a calendar year was in 1995 when HOLLAS recorded 3,549 passes tracked. With the reduction in force occurring in February 2004, tracking statistics declined through the end of the contract.

In June 2004, Mr. David Carter of NASA SLR visited Maui to present the crew and support staff of HOLLAS and the Institute for Astronomy with plaques in appreciation of the many years of service to the SLR experiment. The accompanying photograph shows Mr. Carter presenting the plaques during a celebratory dinner held in honor of the HOLLAS crew.



*Figure B-26. HOLLAS Staff (left to right): Tim Georges, Mike Maberry, Craig Foreman, Jake Kamibayashi, David Carter (NASA), Dan O’Gara, Bill Lindsey Jr.*

## Contact

Dan O’Gara  
University Of Hawaii Institute For Astronomy  
P.O. Box 209  
Kula, HI 96790  
USA

Voice: 808-876-7600 x.106  
Fax: 808-876-7603  
E-mail: [ogara@lure.ifa.hawaii.edu](mailto:ogara@lure.ifa.hawaii.edu)

## Hartebeesthoek, South Africa

*Ludwig Combrinck, Johan Bernhardt/HartRAO*

MOBLAS-6 operates 136 hours per week on a 24-hour 5-day and 8-hour 2-day basis as part of the Hartebeesthoek Radio Astronomy Observatory (HartRAO) Space Geodesy Program in collaboration with NASA.



*Figure B-27. MOBLAS-6 at HartRAO.*

### MOBLAS-6

The MOBLAS-6 system is ranked amongst the SLR global leaders in terms of providing high quality data consistently since 2001.

Some of the upgrades that took place during 2004 are:

- Old air-conditioning units replaced with new higher efficiency units.
- Laser chiller converted to make use of a local compatible refrigerant system with local support.
- Calibration piers equipped with demisters.
- Telescope cable boom motorized.
- Last system configuration update: August 2004

The MOBLAS-6 team members are: Ludwig Combrinck (Program Leader), Johan Bernhardt (Station Manager), Pieter Stronkhorst, William Moralo, Sam Tshefu, Wilson Phogole, Abe Chibwe and Marisa Nickola.

### Contact

Dr. Ludwig Combrinck  
Space Geodesy  
HartRAO  
P.O. Box 443  
Krugersdorp  
SOUTH AFRICA

Voice: +27 12 326 0742  
Fax: +27 12 326 0756  
E-mail: [m6mgr@hartrao.ac.za](mailto:m6mgr@hartrao.ac.za)  
E-mail: [ludwig@hartrao.ac.za](mailto:ludwig@hartrao.ac.za)  
Web: <http://hartrao.ac.za>

## Helwan, Egypt

*Magdy Ibrahim Imam El-Saftawy, Makram Ibrahim Khalil Ibrahim/NRIAG*

The satellite laser ranging activities commenced at Helwan (National Research Institute of Astronomy and Geophysics, NRIAG) with the cooperation of the Czech Technical University in the 1974.

The station was closed from January 2002 until the end of March 2004 due to a shortage of spare parts as was mentioned in the 2001 ILRS Annual Report. During the period from March 28 to May 4, 2004 many modifications were made to the station during the visits of our Czech colleagues (Antonin Novotny, Miroslav Cech, Helena Jelinkova, Ivan Prochazka and Josef Blazej).



*Figures B-28 and B-29. Czech colleagues visiting Helwan SLR station.*

The following modifications were made to the Helwan station:

- Installation of a new SHG (second harmonic generation) in the laser transmitter
- Installation and verification of new motor drivers
- Addition of a new spare high voltage power supply for pulse selector
- Installation of new Coude system mirrors in the mount



*Figures B-30 and B-31. Dr. El-Saftawy and Dr. Ibrahim work on the station.*



*Figure B-32. The staff of the station (clockwise from left): Eng. Abd El-Rahman Ahmed, Dr. Eng. Makram Ibrahim, Dr. Magdy El-Saftawy, Sami Fath-allah, Tarik Salem, Mohamed Yehya.*

### Contact

Dr. Magdy El-Saftawy  
NRIAG  
Space Science Lab. Elmarsed St.  
Helwan  
1421 Cairo  
EGYPT

Voice: +20 2 5560645  
Fax: +20 2 5548020  
E-mail: m\_el@nriag.sci.eg

## NERC Space Geodesy Facility, Herstmonceux, UK

*Philip Gibbs/NSGF*

### Introduction

Roger Wood retired in April 2003 after 13 successful years as Station Manager of the Herstmonceux SLR station. Graham Appleby is now Head of the Facility while Philip Gibbs is the Operations Manager at Herstmonceux. Matthew Wilkinson joined the group in June 2003



*Figure B-33. Pictured from left to right is the team at Herstmonceux: Robert Sherwood, Matthew Wilkinson, Philip Gibbs, Graham Appleby, Victoria Smith and Christopher Potter. Missing from the picture is David Benham (he took it!).*

Throughout the period we have observed all artificial satellites on the ILRS list and are currently ranked in the top five most productive stations in the ILRS network.

### Downtime

During April 2003 we had a fire in our electrical system. Once we had recovered from this we found a number of other problems – most notably within the telescope drives and safety radar systems. This led to a down time of some six weeks before repairs to the telescope were complete. Although the telescope was repaired to a state that made it useable, it continues to experience tracking problems. We have thus undertaken to replace the servo drive system during September 2004 and expect a downtime of up to three weeks.

### Calibration

During 2003 we completed the design and installation of a new in-dome calibration target. Preliminary results using this configuration suggest a significant difference in calibration value compared to our current target, which is at a distance of some 100m from the telescope. The reason for the discrepancy is under investigation using a movable target, but the difference is believed to be due to non-linearities in the SR620 timers. Full details of this ongoing investigation were given at the 14<sup>th</sup> ILRS workshop at San-Fernando, Spain in June 2004. This investigation will not be completed until we have implemented the new Event Timer currently being developed at Herstmonceux. The possibility of determining corrections to historical range data will be explored at that time.

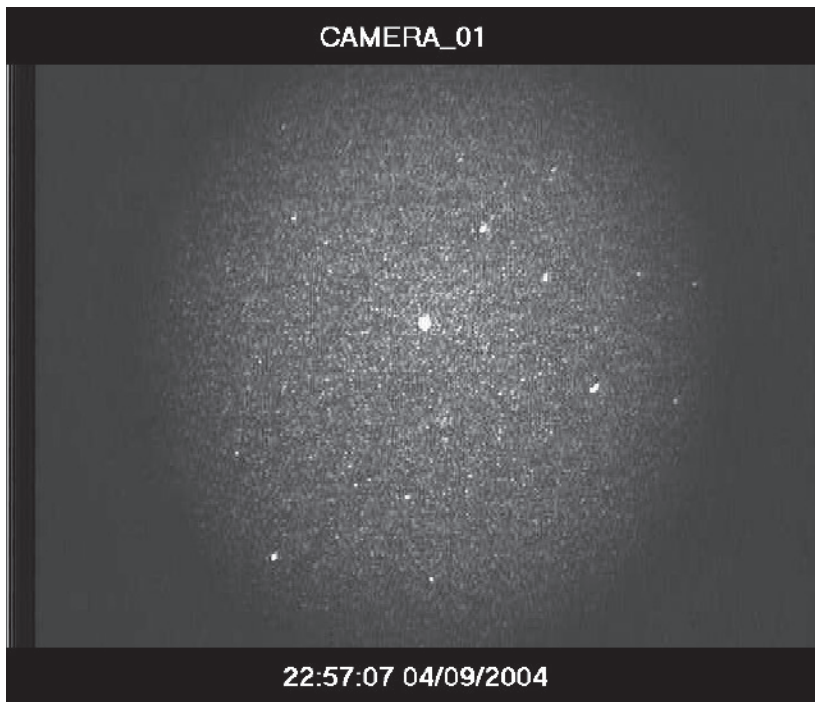

*Figure B-34. Optics. We have upgraded the optics in front of our wide-field acquisition camera to give a field of view of  $\sim 1.8$  degrees and better images. This has helped us find the more difficult objects, Gravity Probe B being a prime current example. The system was also used in an (unsuccessful) attempt to image the MESSENGER Mercury probe. Shown here is Gravity Probe-B (the bright object at the center).*

## GNSS

In March 2003 the Z18 dual GPS/GLONASS receiver HERP was moved to a better horizon on the tower which houses our calibration target 100m from the Facility. The renamed station HERT has since been contributing regular 30s-sampled data hourly and daily to the IGS, as well as distributing navigational data directly via the Internet in support of a EUREF pilot project. In addition a local archive of 1s-sampled data is being maintained. Station HERS has continued to contribute 30s-sampled data to IGS.

## Photometry

In a continuing collaboration with Toshi Otsubo of the National Institute of Information and Communications Technology (NICT), Japan, we routinely collect 'flash' photometric data during all night time ranging sessions to LAGEOS-2. The data are processed on-site to determine precise values of the satellite's spin rate and spin axis orientation.

## Future

We are currently at the beginning of a major hardware and software upgrade program. As mentioned above we are building a high accuracy event timer based upon Thales epoch units. This added capability will enable the next stage of upgrade, namely the purchase of a short-pulse, kilo-Hz laser system, to replace the Nd:YAG system that has been in continuous operation since the start of operations in 1983. The ranging policy will remain that of working strictly at the single photon level, so the single shot jitter will continue to be dominated by satellite signature effects. However, normal point precision will improve by virtue of the increased numbers of observations that will be available for compression.

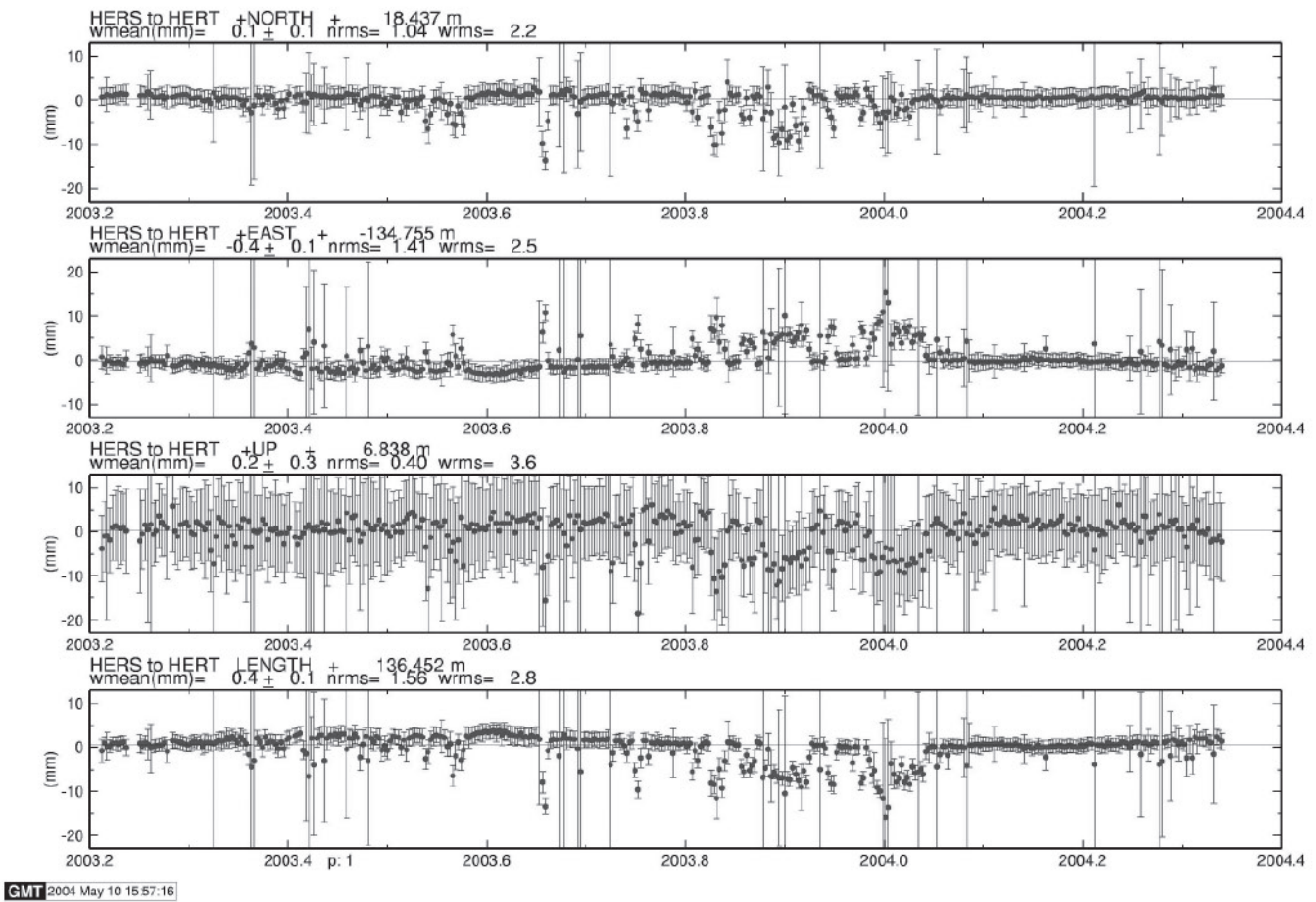

Figure B-35. We have implemented the automated GAMIT/GLOBK GPS analysis software developed at MIT to give us daily baseline values between these two GPS receivers. The accumulative plot (shown here) along with quality control plots (Az, El and time distribution) for both HERS and HERT are placed on the NSGF Web site every day.

Coincident with the laser upgrade, we also have a funded proposal to install for permanent operation in the basement at Herstmonceux an absolute gravimeter, to compliment the space geodetic observations from the site. This proposal is a collaboration between SGF and the Proudman Oceanographic Laboratory (POL) in Liverpool, UK and will certainly complement the POL's long history of involvement in this technique.

## Contact

Dr. Graham Appleby  
 NERC Space Geodesy Facility  
 Herstmonceux Castle  
 Hailsham  
 East Sussex BN27 1RN  
 UK

Voice: +44 (0)1323 833888  
 Fax: 44 (0)1323 833929  
 E-mail: gapp@nerc.ac.uk  
 Web: <http://nercslr.nmt.ac.uk>



## Katzively, Ukraine

### *Yury Kokurin/Crimean Laser Observatory of the Main Astronomical Observatory of the National Academy of Sciences of Ukraine*

The Katzively Laser Ranging station (number 1893) began second-generation operations on LAGEOS in August 1984. Over the next several years, efforts were undertaken to improve station performance to a level necessary for ranging to the Moon. Unfortunately, due to financial and technical difficulties, this work was stopped in 1990. Routine observations of satellites resumed in 1988 and continue today. In 1990, the Katzively station began operations with an upgraded system giving a single-shot rms of about 5 cm and a normal point accuracy of 1-2 cm. The station currently operates with two shifts (two staff members per shift) and an engineering group of six staff members (shown in Figure B-36).

The Katzively station (as shown in Figure B-37) has recently upgraded several components to increase the quantity of observations, allow for daylight tracking, and to increase data accuracy to 1.5-2.0 cm. The characteristics of the Katzively station are as follows:

The laser transmitter:

- wavelength of radiation: 532 nm
- pulse duration: 400 ps (after the upgrade, it is expected to reduce the pulse duration up to 100 ps)
- pulse energy: 100 mJ (after the upgrading, 20 mJ)
- beam diameter: 8 mm
- divergence: 5 arcminutes
- pulse repetition rate: 1-5 Hz

The TPL-1 telescope:

- 2-axes alt-azimuthal mount with a coude focus
- 1 m diameter mirror
- 11.5 m focus of telescope
- divergence of a beam on an output of telescope: 6-50 arcsec
- view field of the main guide: 30 arcmin
- image of a star in the main focus (on a level of energy of 80 %): 6 arcsec
- limit stellar magnitude of a telescope with the amplifier of brightness of image: up to 14 mags
- controlled by the Pentium (75 MHz) PC

The telescope has the combined optical channel for satellite guiding, and the reception of the return signal. Switching of the optical channel from guiding to receiving done at a frequency of up to 10 Hz with a system of two flat rotating mirrors. A velocity of rotation of the mirrors is controlled with a PC and the ephemerides of the satellite. The telescope uses stepping motors located on both axes. The telescope is rotated with a step of 1 arcsec. The maximum velocity of rotation on each of the axes, determined by the type of stepping motor, is up to 2 degrees per second. Fluctuations in the telescope pointing are +/-20 arcsec. With the above-mentioned characteristics, the TPL-1 telescope is capable of ranging to satellites with orbital altitudes from 400 km up to 40,000 km.

The photodetector:

- photomultiplier: Hamamatsu H6279 tube
- quantum efficiency at 532 nm: 8 %
- rms error of temporal measurements at a level of a "photon event": 100 ps
- type of a narrow-band filter: holographic reflective selector
- factor of reflection at 532 nm: 50 %
- filter band pass width: of 1.6 Å

The measurement-information system:

- controlling PC: Pentium (75 MHz)
- range gate: 1 ms - 6.7 s
- programmed width of the range gate: 0.2 microsecond - 3.2 ms
- time interval units: SR-620
- internal rms error of the time interval units: 40 ps
- rms error of registration of the start time: 1.5 ns
- start and stop channel discriminators: fixed threshold
- rms of start and stop pulses: 50 ps
- internal delay calibration error: 300 ps (at one photon event with the SR-620)



Figure B-36. The Katzively SLR staff.



Figure B-37 The Katzively SLR station

The observation data, after the initial reduction, are transferred by e-mail in full-rate and normal point formats to the Ukrainian and international analysis centers. The connection from the Katzively station to the nearest server (in Yalta city) is through telephone modem.

From April 2003 to March 2004, the Katzively station was not operational due to a serious breakdown of the telescope controller. A new controller was installed and observations resumed in April 2004. Over the following six months, the station acquired 540 satellite passes with 8,000 normal points.

Satellite tracking is limited by the unsafe operation of the out-dated equipment, particularly the laser transmitter, whose parameters are no longer compatible with modern requirements. The rms of the full-rate measurements continues to be 5 to 6 cm. The main improvements to the existing system were the installation of the GPS-synchronizable frequency standard, the Trimble "Thunderbolt", which replaced the rubidium frequency standard. An automatic meteorological WMR 928 station by the Oregon Scientific Inc. has also been installed. Furthermore, the switching of the calibration-ranging operation has now been automated.

## Contact

Prof. Yury Kokurin  
Crimean Laser Observatory  
Main Astronomical Observatory of the NAS of Ukraine  
Shulejkin Str., 1  
Katzively, Crimea, 98688  
UKRAINE

Voice: 380(654) 23-75-51  
E-mail: kokurin@clo.ylt.crimea.com

## Kiev, Ukraine

### *Mikhail Medvedsky/Kiev SLR Station*

In 1996, the Kiev SLR station started operations in an experimental status. Permanent operation began in 1999 when the station joined the ILRS tracking network. In 2003, the Kiev SLR station obtained over 1000 satellite passes; in 2004, the station achieved returns from more than 900 passes. The main reason for the decrease in tracking was due to bad weather conditions. The station has nighttime operations only, staffed by a single operator. The single-shot accuracy of the system remains at the 10 cm level. More information about the station can be found on the Kiev Web page at: [http://www.mao.kiev.ua/EOP/slr/kiiev/slr\\_kiev\\_location.html](http://www.mao.kiev.ua/EOP/slr/kiiev/slr_kiev_location.html).

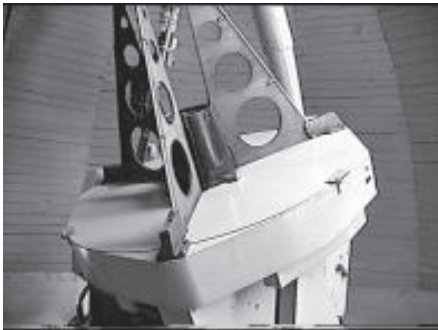

*Figure B-38. Kiev telescope.*

### Contact

Dr. Mikhail Medvedsky  
Kiev-650  
Golosiiv, MAO NAS, 252650  
UKRAINE

E-mail: [medved@mao.kiev.ua](mailto:medved@mao.kiev.ua)

## Lviv, Ukraine

*Andriy Bilinsky, Yaroslav Blagodyr, Alexander Lohvynenko, Sofiya Ternavska/Astronomical Observatory of LNU*

The Lviv Laser Ranging Station (shown in Figure B-39) became operational in 1998. Since then the station has been working in a test mode; the staff (Figure B-40) has become proficient in laser ranging operations and has completed equipment checkout.

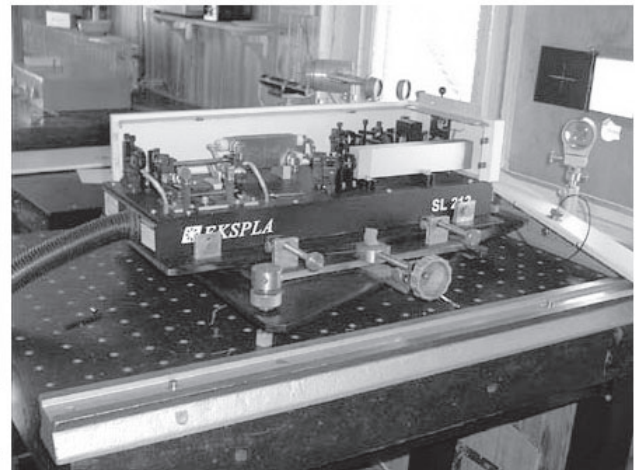
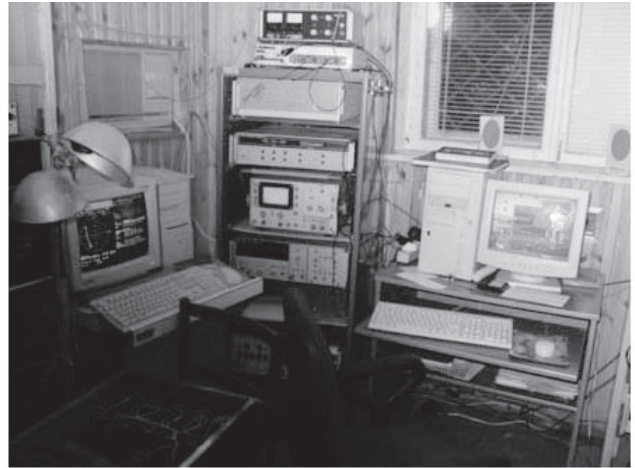

*Figure B-39. Lviv station night ranging, operational room, and laser.*

*Figure B-40. Staff of the Lviv SLR station (from left to right): Andriy Bilinsky, Yaroslav Blagodyr, Sofiya Ternavska, (below from left to right) Gennadiy Kraynyuk, Alexander Lohvynenko, Ivan Vakarchuk.*

In mid-2002, the station joined the ILRS (ILRS station code LVIL, SOD 18318501) (1). During 2002, the station acquired 74 LEO and 20 LAGEOS passes; in 2003, 319 and 11 passes respectively, and during the first three quarters of 2004, 229 and 44 passes respectively. The low productivity is connected with: bad weather conditions, only nighttime operations, and a poor guiding system. The rms for calibration over the past year is about 16 mm. The rms on ERS is 35 mm and on LAGEOS, 50 mm (according to the ILRS quarterly report cards).

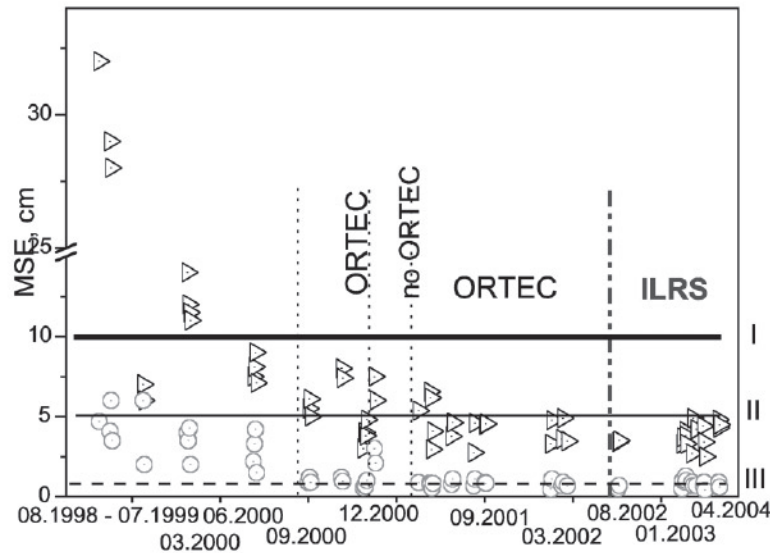

Figure B-41. Ranging accuracy evolution. (*w*-all points, *j*-normal points).

At present, the Lviv group is working on a device for measuring reflected signals intensity from different satellites and a ground target.

## References

1) Lviv SLR station, <http://ilrs.gsfc.nasa.gov/stations/>

## Contact

Alexander Lohvynenko  
Astronomical Observatory of  
Ivan Franko National University of Lviv  
8, Kyryla I Mefodia str.  
79005 Lviv  
UKRAINE

Voice: +380-322-729088  
E-mail: lohvynenko@astro.franko.lviv.ua  
blagod@astro.franko.lviv.ua  
bilian@astro.franko.lviv.ua

## Matera, Italy

*Giuseppe Bianco/ASI*

During years 2003-2004 the MLRO (Matera Laser Ranging Observatory) has passed the Final Acceptance and the one-year warranty period and entered the full-time routine operations phase. The photograph below shows the MLRO engineering and operations crew.



Figure B-42. MLRO engineering and operations crew.

**Table B-1. MLRO Performance Summary**

Satellite information for SLR station 7941 from 2003-01-01 to 2004-12-31:				
Satellite	Start Date	End Date	Number of Passes	Number of Normal Points
AJISAI	15-Jan-2003	30-Dec-2004	506	7301
BE-C	15-Jan-2003	29-Dec-2004	306	6489
CHAMP	21-Feb-2003	01-Aug-2004	10	184
ENVISAT	20-Jan-2003	27-Dec-2004	141	1941
ERS-2	14-Jan-2003	28-Dec-2004	136	1948
ETALON-1	20-Jan-2003	27-Dec-2004	98	469
ETALON-2	20-Jan-2003	30-Dec-2004	147	653
GFO-1	14-Jan-2003	29-Dec-2004	122	1653
GLONASS-84	15-Jan-2003	28-Dec-2004	85	389
GLONASS-86	27-Jan-2003	25-Feb-2003	13	47
GLONASS-87	14-Jan-2003	27-Dec-2004	61	238
GLONASS-89	30-Apr-2003	23-Dec-2004	53	262
GP-B	02-Aug-2004	13-DEC-2004	4	39
GPS-35	15-Jan-2003	01-Aug-2004	30	131
GPS-36	15-Jan-2003	01-Aug-2004	34	163
GRACE-A	20-Jan-2003	20-Jul-2004	8	122
GRACE-B	15-Jan-2003	31-Jul-2004	26	443
JASON	15-Jan-2003	29-Dec-2004	307	7208
LAGEOS-1	14-Jan-2003	30-Dec-2004	577	4745
LAGEOS-2	14-Jan-2003	30-Dec-2004	487	4653
LARETS	29-Nov-2003	23-Dec-2004	57	358
METEOR-3M	28-Jan-2003	25-Feb-2003	2	5
MOON	22-Feb-2003	25-Nov-2004	14	14
STARLETTE	14-Jan-2003	29-Dec-2004	345	2954
STELLA	15-Jan-2003	27-Dec-2004	154	1404
TOPEX	14-Jan-2003	29-Dec-2004	333	6436

Two major events have had a significant impact on the observational activity during this period:

1. Lightwave Laser refurbishment (system down from May 22nd to September 11th, 2003)
2. Telescope azimuth resolver replacement (system down from August 2nd to October 28th, 2004).

Nevertheless, the data production has been quite satisfactory, including two different successful LLR sessions. Table B-1 summarizes the MLRO observational production as per data extracted from the ILRS database.

## Contact

Giuseppe Bianco  
Agenzia Spaziale Italiana (ASI)  
P.O. Box 11  
75100 Matera  
ITALY

Voice: ++39-0835-377209  
Fax: ++39-0835-339005  
E-mail: [giuseppe.bianco@asi.it](mailto:giuseppe.bianco@asi.it)

## McDonald Laser Ranging Station (MLRS)

*Peter Shelus/CSR*

The McDonald Observatory laser ranging station, MLRS, is located in the Davis Mountains of west Texas, near Fort Davis, Texas (USA). The station continued its SLR/LLR activities as a part of the NASA laser ranging network during this report period. The principal source of funding continues to be a operations contract from NASA. However, additional funding is provided by several grants from NASA and the National Science Foundation. Data volume has been severely curtailed, however, due to the reduction in manpower forced by severe funding cuts.

All MLRS SLR and LLR data are available through the ILRS data centers. These data are transmitted to the data centers in near real-time, using standard SLR and LLR formats. Because of the continuing very tight financial situation, there have only been minimal upgrades and improvements at the MLRS. Activity continues to be directed toward keeping the station operational and in a data-gathering mode.

Peter J. Shelus, Project Manager, continued his efforts on behalf of the ILRS, serving as associate director of the ILRS AWG, member of the ILRS Directing Board, and lunar representative to the IERS. Mr. Randall L. Ricklefs, Software Manager, continued his efforts on behalf of the ILRS, serving as a member of the Data Formats Working Group and spearheading the project for a more comprehensive data format to be used for SLR, LLR, and laser transponder data. Mr. Jerry R. Wiant continued as Project Engineer. Observers at the MLRS were Windell L. Williams, Kenny T. Harned. Martin L. Villarreal, and Anthony R. Garcia had to be laid off due to the aforementioned funding cuts. Rachel M. Green served in the role as part-time Technical Assistant.

### Contact

Dr. Peter Shelus  
University of Texas, Center for Space Research  
3925 West Braker Lane, Suite 200  
Austin, TX 78759-5321  
USA

Voice: 512-471-7599  
Fax: 512-471-3570  
E-mail: [shelus@csr.utexas.edu](mailto:shelus@csr.utexas.edu)



## Metsähovi, Finland

*Jukka Piironen, Markku Poutanen/Finnish Geodetic Institute*

SLR observations continued actively in Metsähovi until Matti Paunonen passed away in late 2003. This tragic loss reflected also on the station's SLR observations. The work resumed after the summer of 2004. Future plans are to start the renewal of laser activities during 2005. Eventually the telescope should be replaced by a more accurate one.

The Finnish Geodetic Institute has started geodetic VLBI observations together with the Radio Observatory of Helsinki Technical University. The radio telescope is a 14-meter dish protected by a dome (Figure B-43) and is located at Metsähovi. The S/X receiver is produced by TTI Corporation, Jerez, Spain. During the year a total of four test runs of the systems have been accomplished. According to the tests, the Mark-IV tape drive has problems with its recording heads and thus a Mark-V hard disk device was loaned to us by JIVE. Four of the Base Band Converters had problems, which were corrected during the late 2004. All in all we are now ready for routine campaigns starting from early 2005.



*Figure B-43. Metsähovi radio laboratory.*

### Contact

Jukka Piironen  
Finnish Geodetic Institute  
Geodeetinrinne 2, P.O. Box 15  
FIN-02431 Masala  
FINLAND

Voice: +358-9-2564994  
Fax: +358-9-2564995  
E-mail: [jukka.piironen@fgi.fi](mailto:jukka.piironen@fgi.fi)

## Monument Peak, CA

*Julie Horvath/HTSI*

MOBLAS-4, shown in Figure B-44, supplied SLR tracking from Monument Peak, located on Mt. Laguna, California for its 20th year at this site in 2003. MOBLAS-4 provided tracking coverage on a 24 hours per day, 7 days per week basis during this year.



*Figure B-44. MOBLAS-4 in Monument Peak, CA.*

The MOBLAS-4 continued to be one of the most prolific SLR systems in the world, delivering over 127,000 normal points to the global scientific user community with over 110,000 normal points from the LEO satellites. Data quality was also excellent with single shot LAGEOS RMS consistently averaging below 1 cm. These numbers were achieved at the same time that several engineering issues were addressed during 2003. MOBLAS-4 experienced a very serious azimuth motor drive failure in May that took the system down for 45 days. Engineers were also working to upgrade the aging receive system throughout the year.

As with other NASA systems, the MOBLAS-4 was greatly affected by the severe NASA budget cuts implemented in early 2004. The MOBLAS-4 operating schedule was reduced to three shifts, five days per week. Even with the reductions, the system is still ranked in the top six SLR stations in production with over 77,000 normal points for the year without a degradation in quality of data.

The crew at MOBLAS-4 is: Gary Gebet (station manager), Ted Doroski, and Ron Sebeny.

### Contact

Scott Wetzel  
Honeywell Technology Solutions, Inc. (HTSI)  
7515 Mission Drive  
Lanham, MD 20706  
USA

Voice: 301-805-3987  
Fax: 301-805-3974  
E-mail: [Scott.Wetzel@honeywell-tsi.com](mailto:Scott.Wetzel@honeywell-tsi.com)

## Mount Stromlo, Australia

*John Luck, Chris Moore, Ben Greene/EOS Pty. Limited*

### **Stromlo I (7849 STRL)**

The original Stromlo SLR, established 1998, operated normally for the first 17 days of 2003 whereupon it was consumed by the firestorm which engulfed Canberra on January 18, 2003. The photo shown in Figure B-45 was taken in 1998; the photo in Figure B-46 was taken on the day after the fire.



*Figure B-45. Stromlo 7849, before the firestorm.*



*Figure B-46. Stromlo 7849 on January 19, 2003.*

### **Stromlo III (7825 STL3)**

Fortunately, the station was fully insured and negotiations with Geoscience Australia (GA) to rebuild started immediately. The salient features of the new station include:

- 1.0 meter confocal paraboloid (Mersenne) telescope on Alt/Az mount, by EOS Technologies Inc., Tucson AZ
- PESO Consulting C-SPAD with internally compensated time-walk
- Passively mode-locked 100 MHz laser oscillator to EOS design, selected and amplified to 13 mJ at up to 50 Hz of 10 ps pulses at 532 nm

- Event timing card to EOS design, 0.7 ps resolution, 5 ps precision.
- Fully enclosed Typhoon dome.
- Fully autonomous operation capability.
- Fundamental space geodesy site including IGS GPS and IGLOS GLONASS receivers, IDS DORIS beacon, comprehensive local tie network and experimental facilities for LLR and space debris tracking. Significant milestones include:

**Table B-2. Mt. Stromlo Reconstruction Milestones**

Date	Milestone
4 Jul 03	EOS/GA contract to rebuild the station signed. Construction started immediately if not sooner.
10 Sep 03	EOS/GA contract for SLR Facilities Management and Operations signed.
7 Nov 03	Resumption of GPS radiofrequency observations.
1 Dec 03	Resumption of GLONASS radiofrequency observations.
Dec 03	Comprehensive Local Tie Survey performed by GA ( <i>Johnston et al, 2004</i> ).
30 Dec 03	System ready for trialing.
23 Mar 04	First star calibration for mount model.
1 Apr 04	Official opening by Minister for Industry, Science and Resources. The ceremony was graced by Werner Gurtner.
8 Apr 04	Preliminary Acceptance Tests completed and signed off.
12 May 04	Initial Site Log submitted to ILRS.
28 Jul 04	DORIS beacon re-commissioned.
7 Aug 04	Start of normal data flow to EDC and CDDIS.
17 Sep 04	Revised event timing card installed.
29 Nov 04	Final Acceptance Tests passed.
1 Dec 04	Station officially operational.

Data is flowing to the ILRS associate analysis centers for assessment and, since August 7, 2004, to the data centers for regular use. System delay is being measured with 3 ps accuracy by the MINICO method of ranging to the four ground targets (Luck, 2004). Telescope pointing precision assessed by star calibrations is 0.9 seconds of arc with short-term prediction accuracy of 2.4 seconds of arc.

This system also contains a high-energy laser, 2J into 5ns at 50Hz, to be used for exploratory Lunar Laser Ranging. The Apollo 15 lunar reflector was successfully tracked in September 2004, without actually ranging.

At the time of the firestorm, EOS had started installation of a 1.8 meter EOST Az/El telescope in an IceStorm dome. Its foundations, too, were severely damaged, but rebuilding commenced immediately. This telescope and enclosure are currently undergoing integration tests before being shipped to a final destination to become part of the NASA JPL vis/IR interferometer. Pointing precision is 1 second of arc.

A Differential Image Motion Monitor (DIMM) has been erected on a slim tower eight meters above ground level, for measuring atmospheric seeing. It is based on a 14-inch Celestron telescope.

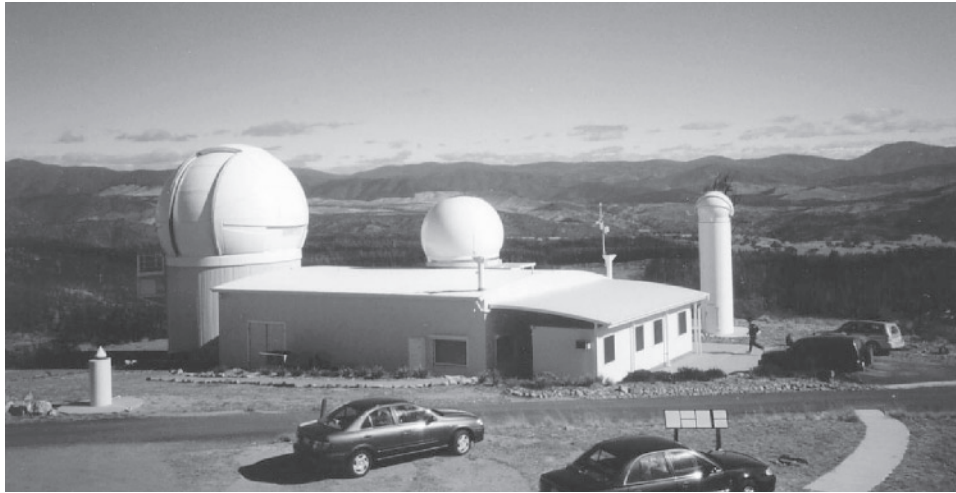

Figure B-47. Stromlo Space Research Centre, May 2004. From left: Fiducial geodetic survey monument; IceStorm dome (space experiments); Typhoon dome (SLR); DORIS antenna (in front of Typhoon); METS tower; DIMM tower and dome.

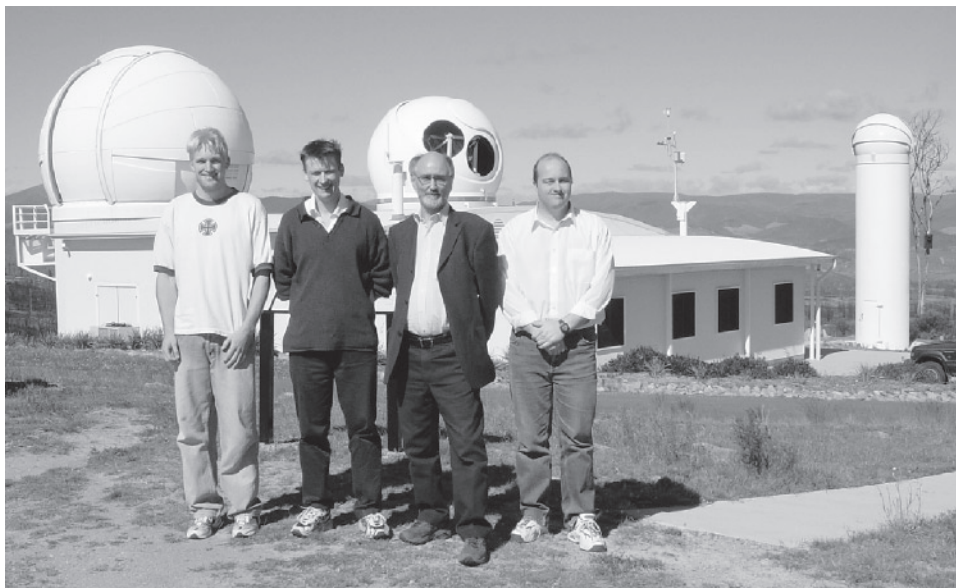

Figure B-48. Mt Stromlo SLR Station staff (left to right): Greg Champion, Garrick Madge, Chris Moore, Peter Wilson

### Staffing of Yarragadee (7090 YARL)

GA's contract to BAE Systems for facilities management and operation of MOBLAS-5 expired on June 30, 2004. The new three-year contract was awarded to EOS Pty.Ltd. effective July 1, 2004. There was a 16-day tracking hiatus due to transitional arrangements, after which the existing staff was re-employed and resumed normal operations at their usual high level. Additional information on the Yarragadee station is provided in a separate report.

## Gravimetry

The three-setup absolute gravity facility in a basement at Mount Stromlo Observatory, established by GA in 1996 with FG5 measurements in 1998, 1999, 2000 and 2002, was also destroyed in the fire. However, although severely damaged, the co-located super-conducting gravimeter, on loan to the Australian National University by the National Institute for Polar Research, was repaired and returned to operation in its old location. GA is proceeding with plans to construct a special-purpose absolute gravity calibration facility in the hillside adjacent to Stromlo SLR, capable of holding six absolute and one superconducting gravimeters. An FG5 machine from Kyoto University undertook absolute gravity measurements at two new points on Mount Stromlo in February 2004.

GA performed a repeat gravimeter occupation at Yarragadee during June 2003, during which a new point was also established a short distance away.

## References

- Johnston, G., J. Dawson and S. Naebkhil (2004): "The 2003 Mount Stromlo Local Tie Survey", Geoscience Australia Record 2004/20
- Luck, J.McK. (2004): "Five-Target System Calibration", Proc. 14th International Workshop on Laser Ranging, San Fernando, Spain, 7-11 June 2004 (in press)

## Contact

Dr. Christopher Moore  
Electro Optic Systems Pty Limited  
111 Canberra Avenue  
Griffith, ACT 2603  
AUSTRALIA

Voice: +61 2 6287-2953  
Fax: +61 2 6287-2951  
E-mail: [slr\\_stromlo@eos-aus.com](mailto:slr_stromlo@eos-aus.com)

## Potsdam, Germany

*Ludwig Grunwaldt/GFZ*

The new Potsdam system (7841), which consists of separate transmit and receive telescopes, officially started its operation in January 2003 and delivers data to the ILRS regularly. The former 7836 station is kept operational in parallel for a certain period to serve both as a caretaker in case of problems with the 7841 system and for public demonstration.



*Figure B-49. The transmit and receive telescopes of station 7841 Potsdam*

The tracking capability of the 7841 system (now designated as Potsdam-3) was limited to nighttime passes during the first months of operation. In summer 2003 a narrowband filter (Omega Optical Inc., 0.39 nm bandwidth, 47% peak transmission) was installed which now allows for satellite acquisition under daylight conditions. While mainly designed for tracking of LEO satellites and LAGEOS, passes of high satellites (up to GPS) can be acquired under nighttime conditions as well. It is planned to improve the data yield for those objects by the installation of an AD230 SPAD (Silicon Sensor, Inc.) in 2004, while LEO satellites will be mainly tracked using a Hamamatsu H5023 hybrid PMT.

In order to reduce possible range bias effects caused by the timing system, a newly developed event timer (A031-ET from Latvian State University, Riga) was purchased and tested for stability and linearity by intercomparing it with the “E.T.” event timer at the Graz station 7839 in February 2004. The results were so encouraging (linearity to a few picoseconds over the full range) that the A031-ET now serves as the main timing device with the SR620 only as a backup.

### Contact

Dr. Ludwig Grunwaldt  
GeoForschungsZentrum Potsdam  
Telegrafenberg  
D-14473 Potsdam  
GERMANY

Voice: +49-331-2881733  
Voice: +49-331-2881164 (SLR station)  
Fax: +49-331-2881732  
E-mail: [grun@gfz-potsdam.de](mailto:grun@gfz-potsdam.de)

## Riga, Latvia

*Kazimirs Lapushka/Astronomical Institute, U. of Latvia*

Routine operations continued during 2003 and 2004 with a total of 2002 satellite passes tracked (as of early October 2004). Nearly all low-orbiting satellites and those up to LAGEOS altitude are tracked on a routine basis. High-orbiting satellites, such as GPS and Etalon, were not tracked due to the lack of the necessary technical and staff resources. Special attention was directed toward ERS-2, CHAMP, and GRACE tracking.

At the end of 2003, we introduced system calibration using a corner cube located close to the secondary mirror in the main transmit-receive channel. Unfortunately, the activation of this system takes several minutes and thus it cannot be used for the pre-post pass calibrations. This method is now used for internal calibration system control using a fiber-optics cable unit. Installation and use of this system has reduced the calibration rms to under 10 mm. System range bias error also was reduced and stabilized.

An electro-optical receiver unit (for satellite returns) was designed and custom-made at the end of August 2004 (Figure B-50). This receiver unit was built to realize low noise level daytime ranging for LEOs and LAGEOS. The receiver contains a narrow-band holographic or ordinary interference filter, a high-quality beam splitter (50:50), a fast coincidence circuit working from 10 nanosecond pulses, pulse formers, and a fast switching unit to select analog pulses from one of the split channels. One H6780-20 optical sensor is used in each channel. After that, the selected signal is led to a CFD and an amplitude converter unit and finally to the event timer unit. At the moment, the results from initial ranging tests to ERS-2, CHAMP, LAGEOS, and other satellites are promising.

In the near future, we plan to develop, and introduce into the normal ranging cycle, a daytime ranging unit. We also plan to change the optical scheme of the telescope for ranging with frequencies over 10 Hz. We hope to optimize ranging conditions for LEOs and system calibration. Figure B-51 shows the telescope optical layout as it is now and Figure B-52 gives a schematic layout of planned changes. We hope to realize these modifications during 2005.

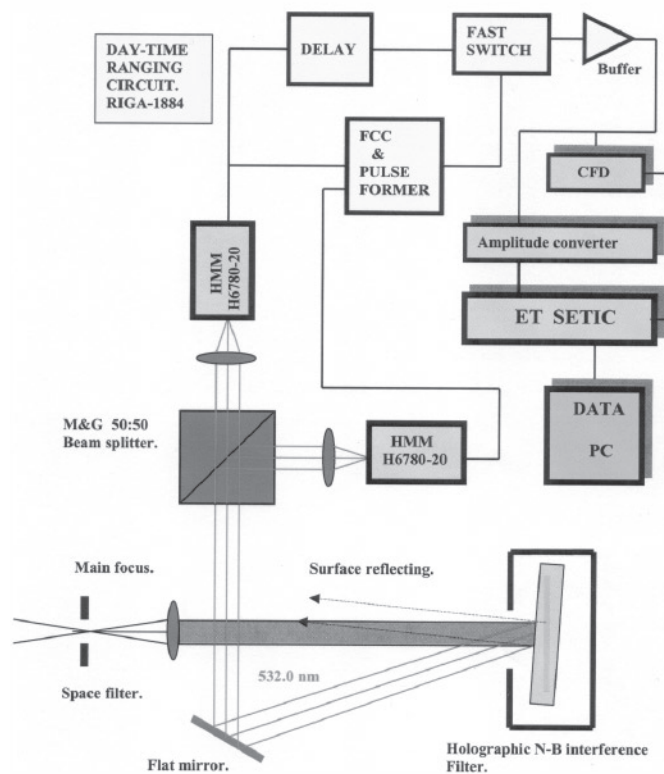
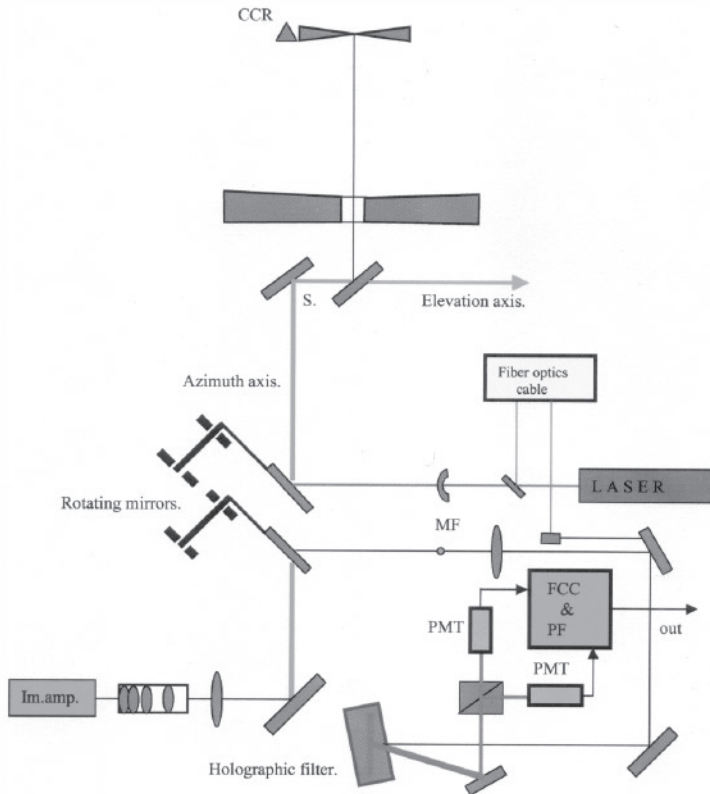

Figure B-50. Schematic of the electro-optical receiver unit.





**Fundamental Geodynamic station RIGA-1884.  
Laser Telescope schematic layout.**

Figure B-51. The current optical layout of the telescope.

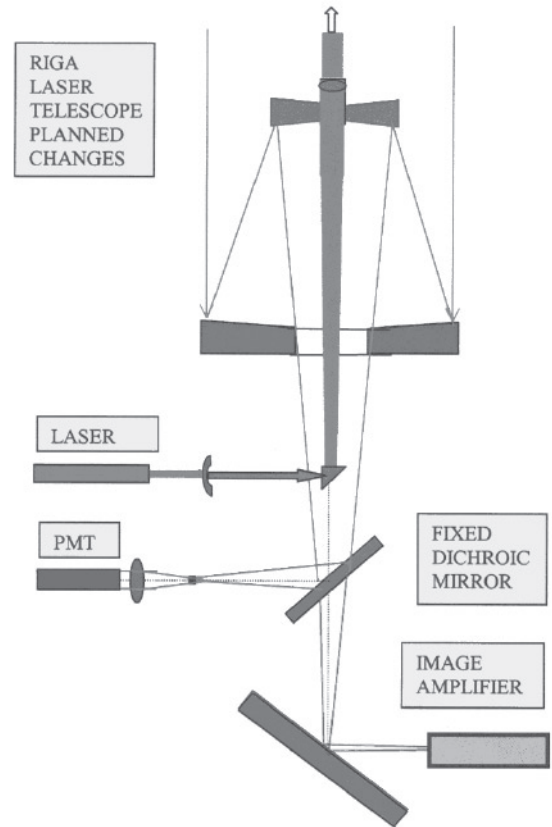

Figure B-52. A schematic layout of planned changes for the telescope optical layout.

## Contact

Dr. Kazimirs Lapushka  
 Astronomical Institute of University of Latvia  
 Blw.Rainis 19  
 Riga, LV-1586  
 LATVIA

Voice: 371 7 611984  
 Fax: 371 7 820180  
 E-mail: riglas@lanet.lv

## San Fernando, Spain

*Jorge Gárate, Jose Martín Davila, Manuel Quijano, Carmelo Belza/Real Instituto y Observatorio Armada*

The staff of the San Fernando SLR station is currently working to improve daylight tracking capabilities for satellites up to LAGEOS altitude. Although we are currently performing daylight tracking of satellites using an XP photomultiplier detector, we are not fully satisfied with the level of accuracy of the results. Since mid-2001, we have used a C-SPAD during nighttime tracking and our performance has dramatically improved. We would like to proceed in a similar fashion during daylight hours.

During the last two years, some positive steps have already been achieved: a new calibration target was installed inside the telescope dome, the laser pulse repetition rate was increased from 5 Hz to 10 Hz in January 2003, and new SR 620 interval counters were purchased. Devices have been installed to monitor the performance of the new equipment by intercomparison of the data.

The laser room was rebuilt during the spring of 2003 in order to install a rack for the new counters and to provide better temperature control. The temperature control has improved laser path alignment and the performance of the counters. The old and new racks are shown in the photographs in Figures B-53 and B-54 below. The observer post has also been improved, as is shown in Figure B-55.



*Figure B-53. Old equipment rack.*



*Figure B-54. New rack configuration.*

We are still working on the telescope system control. The mount movement is not as smooth as needed for tracking satellites with the narrowest diaphragms. It is not a critical problem for nighttime tracking, because a wider diaphragm is adequate to perform acceptable tracking. This is not the case, however, in daylight, when noise masks the signal echoed



Figure B-55. San Fernando observer post.

by the target.

The SLR station hosted a visit by the FTLRS in mid-2004 for a collocation experiment.

We are making progress toward three-shift operation using the C-SPAD detector. As soon as we achieve this objective we will prepare the system for tracking satellites beyond the LAGEOS altitude. This work has been partially funded by the Spanish “Ministerio de Ciencia y Tecnología” through the Research Project ESP2001-4514-PE. We would also like to acknowledge the Spanish Navy for its funding support.

San Fernando SLR staff was also involved in hosting and organizing the 14<sup>th</sup> International Laser Ranging Workshop, which was held in San Fernando, June 7-11, 2004. The photograph shown

in Figure B-56 was taken when the workshop participants visited the Observatory.



Figure B-56. Attendees of the 14<sup>th</sup> International Workshop on Laser Ranging.

## Contact

Jorge Garate  
Real Instituto y Observatorio Armada  
Sec. Geofísica, C. Cecilio Pujazon S/N  
11110 San Fernando, Cadiz  
SPAIN

Voice: 34-956-599285  
Fax: 34-956-599366  
E-mail: jgarate@roa.es

## Simeiz, Ukraine

*Lazar Shtirberg, Andrew Dmytrotsa, Oleg Minin, Dmitriy Neychenko/Crimean Astrophysical Observatory*

### Introduction

At the present time seven SLR stations in the ILRS network are using the “Crimea” type telescope. Four of them are working in the Ukraine. The “Crimea” telescope was designed about 20 years ago, and now needs some technical improvements.

Modernization of the SLR station “Simeiz-1873” was started in 1998 through a grant from Commercial Research and Development Foundation (UG1-332) and an agreement for the installation of a permanent GPS receiver with UNAVCO (USA). Between 1998 and 2000 technical improvements were made in the electronics, software, and mechanical subsystems of the telescope.

A permanent GPS receiver was installed in 2000 at the SLR site, and now we are using the rubidium clock from the GPS receiver as the station clock. Over the last few years we have continued to improve both the optics and the electronic subsystems. As a result, both the data yield and data quantity have increased noticeably (1) and the station has been able to acquire some passes on the high-orbiting satellites GPS, GLONASS, and Etalon.

The Simeiz now has the following configuration:

- Mount Configuration: AZ/EL
- Laser Type: ND:YAG
- Wavelength: 532 nm
- Pulse Energy: 30-80 mJ
- Repetition Rate: 5 Hz
- Receiver Aperture Diameter: 1 m.
- Detector Type: PMT(H6533)
- Time interval counter: SR620 (25 ps precision)
- Angular sensors: Farrand-Controls (0.4’)

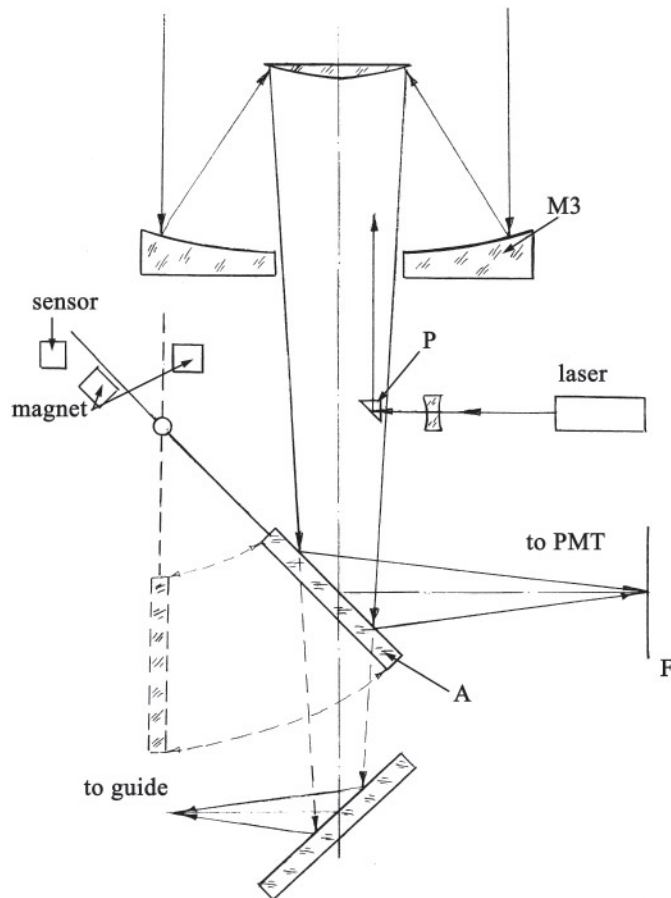

Figure B-57. Design for new Simeiz optical system.

### Optical Subsystems

The 1-meter aperture telescope is used for both sending and receiving laser pulses and for visual tracking. We have designed a new optical system that has two modes: ranging and visual tracking so we can readily switch back and forth (see Figure B-57). The transmitting path passes through prism P, which fills about 12-15% of the aperture. The receiving path passes to mirror A, which has two positions, which are fixed by magnets and controlled by an electrical motor and a sensor. In the first position, mirror A reflects the light to the PMT. In the second position, the mirror is out of the path and light passes on for visual sighting and guiding. During ranging, the optics in this unit are motionless. The second

position of mirror A is used for visual tracking, which can extend down to objects at 14 magnitude.

We continue to work on increasing the laser repetition rate up to 10 Hz (5 Hz at present), implementing an automated calibration system (external and internal), and developing a new telescope-pointing model.

We made several oral presentations at the “Third Ukrainian Conference of Perspective Space Investigations (Katsively, Crimea, 2003)” and the “Astronomical school for young scientists (‘White Crouch’, 2003)” (2-9).

## References

- 1) Dmitrotsa A., Minin O., Neyachenko D., Shtirberg L., Tatevian S. “Upgrading of the Simeiz-1873 SLR Station”, 13-th International Workshop on Laser Ranging “Toward Millimeter Accuracy”, October 7-11, 2002, Washington, NASA USA.
- 2) Minin O.A., Dmytrotsa A.I. Optimal system for satellite ranging with telescope series “Crimea” for SLR. Thesis of “Astronomical school for young scientists”. White Crouch, 2003, P.27
- 3) Minin O.A., Dmytrotsa A.I. About possibilities to take centimeter precision on PMT-79. Thesis of “Astronomical school for young scientists”. White Crouch, 2003, P.27
- 4) Dmytrotsa A.I., Methodics investigation for telescope pointing error model. Thesis of “Astronomical school for young scientists”. White Crouch, 2003, P. 14
- 5) Shtirberg L.S., Dmytrotsa A.I., New way to construction of optical subsystem SLR station based on a telescope “Crimea”. Thesis of “Astronomical school for young scientists”. White Crouch, 2003, P.32
- 6) Shtirberg L.S., Dmytrotsa A.I., Minin O.A., Realization of optimal structure SLR in present demands. “Third Ukrainian conference of perspective space investigations”, Katsively, 2003. P.162.
- 7) Shtirberg L.S., Artemov I.V., Neyachenko D.I., Dmytrotsa A.I., Minin O.A., Shlikar G.N. Automatic calibration on a SLR based on a telescope “Crimea” while satellite ranging. “Third Ukrainian conference of perspective space investigations”, Katsively, 2003. P.174
- 8) Dmytrotsa A.I., Neyachenko D.I., Shtirberg L.S., Zenkovich A.D., Dmytrotsa I.I., Nikolenko I.V., Using one meter telescope “Crimea” for control of navigation satellites in visual mode. “Third Ukrainian conference of perspective space investigations”, Katsively, 2003. P.166
- 9) Shtirberg L.S., Dmitrotsa I.I., Neychenko D.I., Dmytrotsa A.I., Minin O.A., Filikov C.V., Artemov I.V., Tatevian S.K. SLR ranging GLONASS satellites in Simeiz. “Third Ukrainian conference of perspective space investigations”, Katsively, 2003. P.169

## Contact

Dr. Lazar Shtirberg  
Crimean Astrophysical Observatory  
Nauchny, Crimea, 334413  
UKRAINE

Voice: 38 0654 240370  
Fax: 38 06554 40704  
E-mail: lazar@crao.crimea.ua

## Simosato, Japan

*Tadashi Ishikawa/Hydrographic and Oceanographic Department, Japan Coast Guard*

The Simosato Hydrographic Observatory (Figure B-58) is located to the south of Kii Mountain Range which was registered into UNESCO World Heritage in July 2004 as part of the “Sacred Sites and Pilgrimage Routes”; it is the bucolic area of central Japan and about four hours by train from Osaka, the second largest city of Japan. Since the site is close to the Pacific coast with the mountainous area located behind, the meteorological conditions do not always allow laser tracking.



*Figure B-58. The Simosato Hydrographic Observatory and staff (l. to r.: Mitsugu Nagaoka, Takashi Kurokawa, Yuichi Kyuma, Takahiro Hatagami, Asato Egawa, Hidekazu Inoshiro, Megumi Inoue).*

The observatory is currently composed of seven staff members including the director. In April 2003, two members of the observatory staff were replaced and in September 2003 the director was replaced. Until recently, two staff members conducted satellite tracking observations almost every day and night. However, a staff shortage has hindered full 24-hour operations in recent months.

The SLR tracking system undergoes regular maintenance by the professional staff eight times a year and any system upgrade is carried out in a step-by-step fashion. In July 2003, an anomalous range bias was detected; the problem was corrected by replacing the observation counter in October 2003. In December, parts of the optical devices around the start pulse detector were streamlined. Consequently, the transmission energy loss was reduced by half and the return rate was improved.

Nevertheless, some portions of the system, such as the telescope, parts of the controlling and signal receiving electric circuits, are still composed of the original parts introduced in 1982 and need to be replaced to attain higher quality observations. The HP5370B observation counter was replaced with a SR620 at July 2004. Some parts of the electric circuits are scheduled to be replaced next year.

### Contacts

Mitsugu Nagaoka, Chief  
Takashi Kurokawa, Deputy Chief  
Simosato Hydrographic Observatory  
1981 Simosato Nachi-katuura Town  
Higashimuro District  
Wakayama Prefecture 649-5142  
JAPAN

Voice: +81-735-58-0084  
E-mail: shimosato@kaiho.mlit.go.jp

## Tahiti, French Polynesia

*Guilhem Barruol/Université de Polynésie Française*

The Tahiti MOBLAS-8 station was installed in 1997 on the campus of the University of French Polynesia (UPF). A cooperative agreement between the UPF, NASA, and CNES (Center National d'Etude Spatiale, i.e., the French space agency) provides for operations until 2007.

This station is part of the OGT (Observatoire Géodésique de Tahiti) that manages other geodetic instruments: an Argos system, a DORIS antenna, a NGA (National Geospatial-Intelligence Agency) GPS receiver, and two CNES GPS (THTI and PAPE) receivers.



Figure B-59: The MOBLAS-8 station in Tahiti.



Figure B-60: The MOBLAS-8 station at night.

### MOBLAS Crew and Organization

During 2003-2004, three technicians have been responsible for laser station operations. The station personnel, employed either by the UPF or by the CNES, are:

- Bastien Jouanneau (UPF)
- Yannick Vota (UPF)
- Marc Teheipuarii (CNES)

The former director of the OGT, Keitapu Maamaatuaiahutapu, was replaced by Guilhem Barruol in June 2004.

Tracking operations are nominally performed six nights per week throughout the year, with some expected limitations due to weather conditions. The station personnel were trained in tracking operations and maintenance by two HTSI engineers, George Davisson in 2001-2002 and Kenneth Tribble in 2003. Since January 2004, operations are completely autonomous by the station team.

### Recent Developments

As shown in Figures B-62 and B-63, tracking from January 2003 through August 2004 has yielded approximately 15,000 normal points per year.



Figure B-61. The MOBLAS-8 crew. From left to right: K. Tribble, M. Teheipuarii, B. Jouanneau, and Y. Vota.

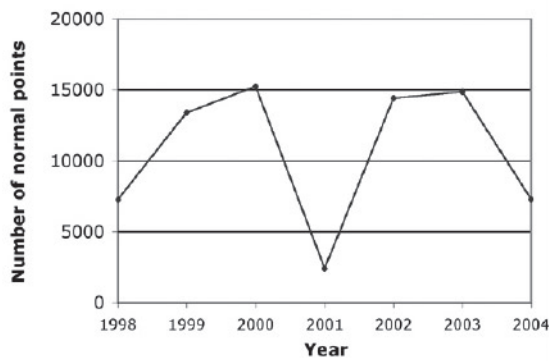

Figure B-62. Total number of normal points obtained in Tahiti since 1998. Year 2004 includes measurements from January to August.

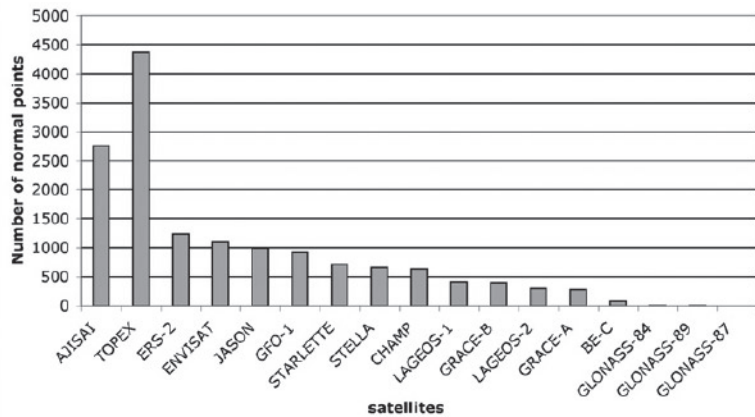

Figure B-63. Number of normal points obtained during the year 2003 at the Tahiti MOBLAS-8 station for the various satellites.

## Contact

Guilhem Barruol  
 Université de Polynésie Française  
 B.P. 6570  
 Faa'a Aéroport  
 98702 Tahiti  
 POLYNÉSIE FRANÇAISE

Voice: (689) 803 884  
 Fax: (689) 803 842  
 E-mail: [guilhem.barruol@upf.pf](mailto:guilhem.barruol@upf.pf)  
 Web: <http://www.upf.pf/jeto/geos/laser.html>



## Tanegashima, Japan

*Takashi Uchimura, Shinichi Nakamura/Flight Dynamics Division, JAXA*

### Introduction

The Japan Aerospace Exploration Agency (JAXA) Satellite Laser Ranging system, which is called GUTS-SLR (Global and High Accuracy Trajectory Determination System), was completed in the spring of 2004. The GUTS-SLR is located in Tanegashima Island, home to the Japanese launch site. The GUTS-SLR system, shown in Figure B-64, is operated by remote control from the Tsukuba Space Center (TKSC), approximately 1100 km away. We started routine operation at the site on September 1, 2004.

### Facilities/Systems

The GUTS-SLR system is capable of ranging to satellites from low Earth orbit to geostationary orbit. The GUTS-SLR system will be able to range to the LAGEOS satellites with a single-shot RMS of less than 10 mm; less than 30 mm RMS is expected for ETS-VIII (JAXA geostationary satellite). The GUTS-SLR station is operated nearly automatically according to the predetermined sequence. An operator minimally needs to turn on/off the initial power supply, manually operate the initial acquisition when the orbit prediction has an error, and perform maintenance on the system regularly. An operational plan for the entire GUTS system has been designed by the Master Control and Operation Planning Subsystem (COPs). COPs also monitors operational conditions of each subsystem.



*Figure B-64. GUTS-SLR at Tanegashima, Japan.*

### Current Activities

GUTS-SLR has tracked only three satellites (LAGEOS-1, LAGEOS -2 and Ajisai) since the start of routine operations. The facility was hit by six typhoons this year and has had some system problems such as leak in the roof of dome and a failure of the dome shutter drive system. The GUTS-SLR operation will resume in early 2005.

### Near Future Plan

GUTS-SLR is now preparing for the restricted SLR operation of the ALOS mission. As a part of this preparation, we will modify the station planning software to adjust to the format used in the GP-B mission.

### Contacts

Takashi Uchimura, Shinichi Nakamura  
Flight Dynamics Division  
Consolidated Space Tracking and  
Data Acquisition Department  
Office of Space Flight and Operations, JAXA  
JAPAN

Voice: +81-29-868-2624/2625  
Fax: +81-29-868-2990  
E-mail: [uchimura.takashi@jaxa.jp](mailto:uchimura.takashi@jaxa.jp)

## Wettzell Laser Ranging System (WLRS), Germany

*Nik Brandl/BKG*

After installing the event timer with four Dassault timing modules and the user interface based on LabVIEW, peripheral components such as the receivers were improved, e.g., in accuracy and in sensitivity. The calibration path was optimized.

The stabilisation of the temperature at the laser oscillator could be tremendously improved.

Because of the rotating mirror used in the system, the measurements to the close satellites CHAMP and GRACE were not possible. With a mechanical alternation, the shift between sending and receiving mode will be about 1.8 ms faster, which will enable us now to observe the low orbiting satellites.

Now with partial automation and new options for extensive diagnoses and analyses, the procedure of measuring (recognition of hits, control of intensity, evaluation and transfer of data) has become more stable and by far more reliable.

The reintroduction of two color measurements is planned in near future.

### Contact

Nik Brandl  
Bundesamt fuer Kartographie und Geodaesie  
Fundamentalstation Wettzell  
Sackenrieder Str. 25  
D-93444 Kötzing  
GERMANY

Voice: +49 (0) 9941 / 603-118  
Fax: +49 (0) 9941 / 603-222  
E-mail: brandl@wettzell.ifag.de

## Yarragadee, Australia

*Vince Noyes/EOS Pty. Ltd.*

### General Information

At the start of 2003, MOBLAS-5 personnel implemented a pseudo 24-hour tracking schedule, putting in place a tracking schedule that was on trial through 2002. Single-man overlapping shifts are now normal, with two-man shifts used for maintenance. Tracking days are 21 hours long, on average. This schedule has resulted in the most productive period for the site with over 1,000,000 data points per month being common.

On July 01, 2004 a new service provider was awarded the contract to operate and maintain the Yarragadee site. EOS Space Systems Pty Limited replaced BAE Systems. EOS employed the site personnel on July 17, 2004 when station operations resumed.

MOBLAS-5 joined Eurostatus during 2004, helping the station and others sites keep up to date with the latest time bias information on all satellites.

MOBLAS-5 celebrated 25 years of continuous operations on October 3, 2004.

### System Upgrades

On November 27, 2003, a new DORIS antenna was installed by MOBLAS-5 personnel and surveyed in by Geoscience Australia. The new pier replaces the old metal guide wire antenna and is a solid concrete type for stability.

During 2003, the functionality of two receive cables and two video cables became intermittent due to boom arm movement during storage and use. To remedy this situation, the crew designed a new boom arm with a different lowering point. This new boom arm has also been automated to raise and lower with the roof and doors closures.

There have been various upgrades on PCs and monitors over the last two years. Newer flat screen displays have enabled a new monitor at the tracking console, which carries the latest weather radar image for rain cloud detection. This in turn has improved data collection by extending the operational period before the van has to be closed for adverse weather conditions.

### Contact

Vince Noyes  
EOS Space Systems  
P.O. Box 137  
Dongara, Western Australia 6525  
AUSTRALIA

Voice: 618-99291011  
Fax: 618-99291060  
E-mail: [moblas@midwest.com.au](mailto:moblas@midwest.com.au)

## Zimmerwald Observatory

Werner Gurtner, Eugen Pop, Johanne Utzinger/AIUB

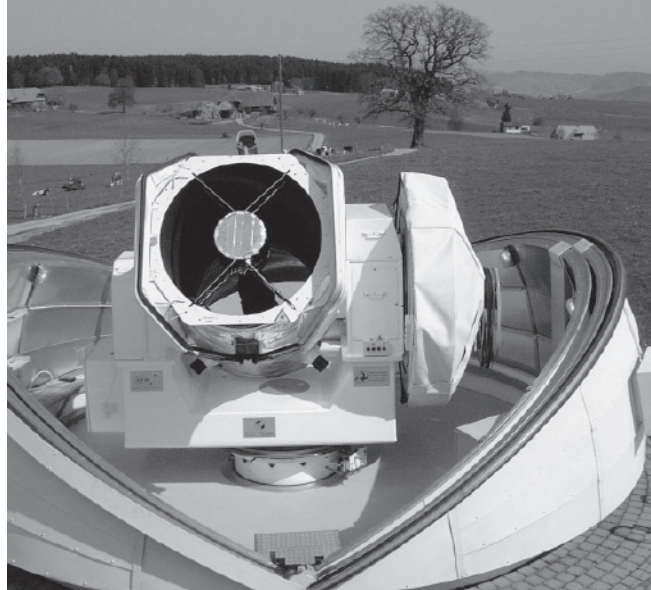

Figure B-65. 1-Meter dual-purpose telescope.

Thanks to a continuous improvement of the system hardware and software since the installation of the new satellite laser ranging and astrometric telescope in 1995-1997 (Figure B-65) the number of observations per year has steadily increased as shown in Figure B-66.

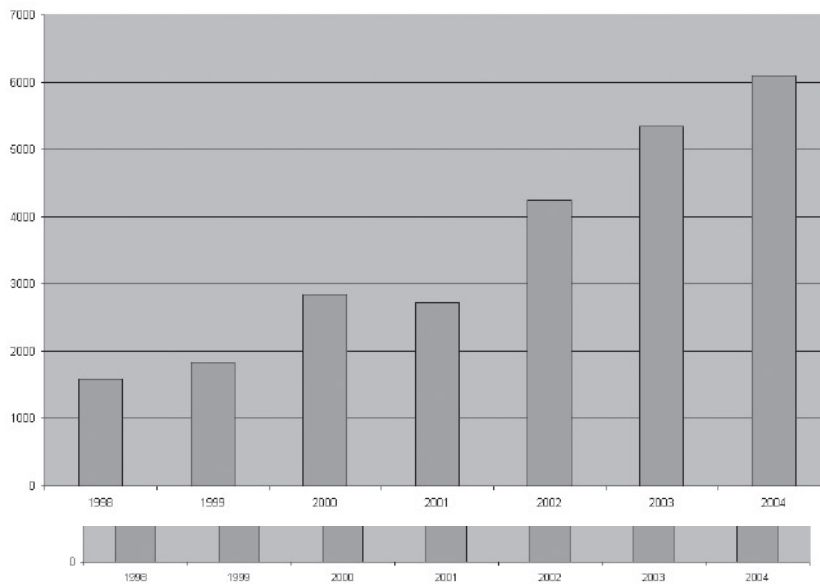

Figure B-66. Number of passes per year (1998-2004, October-September).

The reliability of the system has been improved, with decreased downtimes, both in number and in length.

The introduction of hardware components and software modules for automation allows us to extend the lengths of the two daily observer's shifts for a full 24 hours of operation. During the last two years 20 percent of the passes were collected in automated (unattended) mode. This mode can be used both during nighttime and daylight. The average data yield per pass does not significantly differ from operation under observer control. The major difference is the ability to react to unforeseen events like system crashes, mechanical problems, unexpected weather changes, bad prediction quality, etc. by the operator.

In 2002 we started with two-color ranging, using both the primary wavelength of the Titanium-Sapphire laser in the infrared (846 nm) and the frequency-doubled second harmonic at 423 nm (blue). On August 13, 2002, the first dual-wavelength passes were submitted to the ILRS data centers.

The sensors used for the two colors are:

- Wavelength 423 nm: Hamamatsu H 6533 Photomultiplier C-SPAD since March 2003
- Wavelength 846 nm: Hamamatsu H 7422P-50 Photomultiplier

Due to damage of several optical components we could not continue uninterruptedly with the simultaneous observations in the two colors. Figure B-67 shows the periods of the observations in each color since 2002. Thanks to the infrared path we continued to observe during the winter 2003/2004 while awaiting a new second harmonic generator crystal.

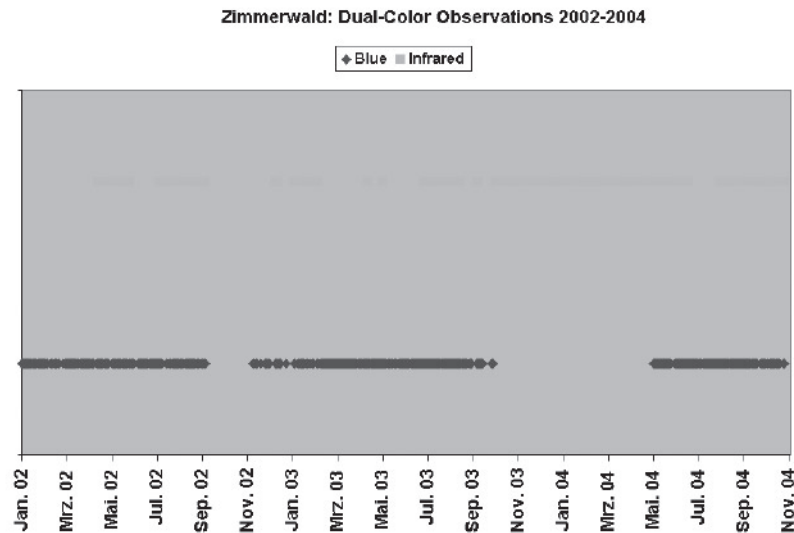

Figure B-67. Observation periods for the two colors.

The accuracy of the individual observations or even the color-dependent normal points is not yet sufficient for the recovering of the total troposphere delay from the difference of the two colors. We find significant differences between the simultaneous normal points at the two wavelengths (up to about 15 mm), corrected by the standard Marini-Murray delays, even after careful, independent calibration (Figure B-68). These residual differences may not be due entirely to errors in the troposphere correction model. Other sources may be the satellite target signatures or unknown biases in the ranging system.

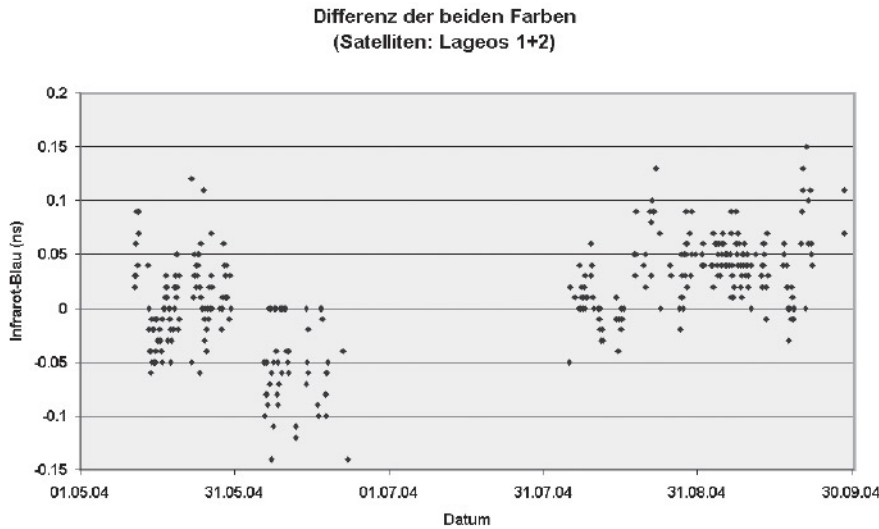

Figure B-68. Average residual differences between the two colors per pass.

Zimmerwald was one of the first ILRS stations to include the vulnerable ICESat into its tracking program. Special software measures had to be implemented to assure that tracking is automatically limited to a 70 degrees maximum elevation in order to avoid damage of the onboard receiver of the laser altimeter.

As a dual-purpose instrument, the telescope is also used for optical (CCD) observations of celestial targets (mainly satellites and space debris, occasionally also near-Earth asteroids). The system control allows a rapid switching between SLR and CCD within 10 to 20 seconds. CCD observations to such targets are routinely interleaved with SLR tracking of medium- and high-altitude satellites.

Future work will be mainly devoted to the improvement of the single shot accuracy (control of the laser pulse length, time interval counter vs. event timer, electronics) and of the transparency of several optical components: losses in the laser power between pulse generation and telescope exit and on the way back to the receivers are too large.

## Contact

Werner Gurtner  
 Astronomical Institute University of Bern  
 Sidlerstrasse 5  
 CH-3012 Bern  
 SWITZERLAND

Voice: +41-31-6318591 (institute)  
 Voice: +41-31-8190050 (Observatory)  
 Fax: +41-31-6313869  
 E-mail: [werner.gurtner@aiub.unibe.ch](mailto:werner.gurtner@aiub.unibe.ch)

---

# APPENDIX C

## ILRS INFORMATION







# APPENDIX C

---

## ILRS INFORMATION

### ILRS Organizations

<b>Agency</b>	<b>Country</b>
Geoscience Australia/National Mapping Division.....	Australia
Austrian Academy of Sciences .....	Austria
Central Laboratory for Geodesy, Bulgarian Academy.....	Bulgaria
Academia Sinica .....	China
Chinese Academy of Surveying and Mapping.....	China
State Seismological Bureau .....	China
Yunnan Observatory.....	China
Technical University of Prague.....	Czech Republic
National Research Institute of Astronomy and Geophysic (NRIAG).....	Egypt
Finnish Geodetic Institute.....	Finland
Observatoire de la Côte d'Azur/Center d'Etudes et de Recherches Géodynamiques et Astrométrie (OCA/CERGA).....	France
Observatoire de Paris .....	France
Tahiti Geodetic Observatory, University of French Polynesia (UFP) .....	French Polynesia
Bundesamt für Kartographie und Geodäsie (BKG).....	Germany
Deutsches Geodätisches ForschungsInstitut (DGFI).....	Germany
European Space Agency (ESA) .....	Germany
Forschungseinrichtung Satellitengeodäsie (FESG) .....	Germany
GeoForschungsZentrum (GFZ) .....	Germany
Technical University of Munich .....	Germany
University of Hannover/Institut fuer Erdmessung.....	Germany
Indian Space Research Organization (ISRO) Telemetry Tracking and Command Network (ISTRAC).....	India
Astronomical Observatory of Cagliari.....	Italy
Italian Space Agency (ASI) .....	Italy
Hydrographic Department/Japan Coast Guard .....	Japan
Japan Aerospace Exploration Agency (JAXA).....	Japan
National Institute of Information and Communications Technology (NICT) .....	Japan
Astronomical Observatory, University of Latvia.....	Latvia
Division for Electronics, Forsvarets ForskningsInstitut (FFI).....	Norway
Universidad Nacional de San Augustin (UNSA).....	Peru
Space Research Center of the Polish Academy of Sciences (PAS) .....	Poland
Institute of Applied Astronomy (IAA).....	Russia
Institute of Astronomy of the Russian Academy of Sciences (INASAN) .....	Russia

Institute of Metrology for Time and Space (IMVP) .....	Russia
Mission Control Center (MCC) .....	Russia
Russian Space Agency (RSA).....	Russia
Space Research Institute (SRI) for Precision Instrument Engineering .....	Russia
King Abdulaziz City for Science and Technology (KACST) .....	Saudi Arabia
Hartebeesthoek Radio Astronomy Observatory (HartRAO) .....	South Africa
Real Instituto y Observatorio de la Armada.....	Spain
Astronomical Institute, University of Berne (AIUB) .....	Switzerland
Delft University of Technology (DUT) .....	The Netherlands
Crimean Astronomical Observatory .....	Ukraine
Lebedev Physical Institute in the Crimea .....	Ukraine
Main Astronomical Observatory (MAO) of the National Academy of Sciences of Ukraine .....	Ukraine
Natural Environment Research Council (NERC).....	United Kingdom
University of Newcastle Upon Tyne.....	United Kingdom
Harvard-Smithsonian Center for Astrophysics .....	USA
Jet Propulsion Laboratory (JPL) .....	USA
National Aeronautics and Space Administration Goddard Space Flight Center (NASA GSFC) .....	USA
Naval Center for Space Technology (NCST) .....	USA
University of Hawaii.....	USA
University of Texas at Austin .....	USA
University of Texas, Center for Space Research (CSR) .....	USA

## List of Acronyms

AAC	Associate Analysis Center
AC	Analysis Center
ADEOS	Advanced Earth Observing Satellite
AGU	American Geophysical Union
AIRS	Atmospheric Infrared Sounder (USA)
AIUB	Astronomical Institute of Berne (Switzerland)
ALOS	Advanced Land Observing Satellite
ANDE	Atmospheric Neutral Density Experiment (USA)
ANSI	American National Standards Institute
APOLLO	Apache Point Observatory Lunar Laser-ranging Operation (USA)
ARTEMIS	Advanced Relay And Technology Mission
ASI	Agenzia Spaziale Italiana (Italian Space Agency)
AVNIR	Advanced Visible Near-Infrared Radiometer (Japan)
AWG	Analysis Working Group
BE-C	Beacon Explorer C
BIPM	International Bureau of Weights and Measures
BKG	Bundesamt für Kartographie und Geodäsie (Germany)
Cal/Val	Calibration/Validation
CAO	Central Aerological Observatory (Russia)
CASM	Chinese Academy of Surveying and Mapping
CB	Central Bureau
CCD	Charge-Coupled Device
CCR	Corner Cube Reflector
CDDIS	Crustal Dynamics Data Information System (USA)
CERGA	Centre d'Etudes et de Recherches Géodynamiques et Astrométrie (France)
CfA	Center for Astrophysics (USA)
CGS	Centro di Geodesia Spaziale (Italy)
CHAMP	CHALLENGING Mini-Satellite Payload
CLG	Central Laboratory for Geodesy (Bulgaria)
CLS	Collecte, Localisation, Satellites (France)
CMB	Core Mantle Boundary
CNES	Centre National d'Etudes Spatiales (France)
CODE	Center for Orbit Determination in Europe
CoM	Center of Mass
COPs	Control Operation Planning Subsystem (Japan)
COSPAR	Committee on Space Research
CPF	Consolidated Prediction Format
CPP	Combination Pilot Project
CRL	Communications Research Laboratory (Japan)
C-SPAD	Compensated Single Photoelectron Avalanche Detector
CSR	Center for Space Research (USA)

CSRIFS	Combined Square Root Information Filter and Smoother (Finland)
CSTG	International Coordination of Space Techniques for Geodesy and Geodynamics
DEOS	Department of Earth Observation (The Netherlands)
DGFI	Deutsches Geodätisches ForschungsInstitut (Germany)
DIMM	Differential Image Motion Monitor
DoD	Department of Defense (USA)
DORIS	Doppler Orbitography and Radiopositioning Integrated by Satellite
DPSSL	Diode Pumped Solid State Laser
DRTS	Data Relay Test Satellite (Japan)
DTOF	Differential Time of Flight
DUT	Delft University of Technology (The Netherlands)
EDC	EUROLAS Data Center (Germany)
EGS	European Geophysical Society
EGU	European Geophysical Union
ENSO	El Niño/Southern Oscillation
EOP	Earth Orientation Parameter
EOS	Earth Observation Summit
EOS	Earth Observing System (USA)
EOS	Electro Optical Systems (Australia)
ERS	European Remote Sensing Satellite
Er:YAG	Erbium Yttrium Aluminum Garnet
ESA	European Space Agency
ESOC	ESA Space Operations Center
ET	Event Timer
ETS	Engineering Test Satellite
EU	European Union
EUROLAS	European Laser Consortium
FAA	Federal Aviation Administration (USA)
FESG	Forschungseinrichtung Satellitengeodäsie (Research Facility for Space Geodesy, Germany)
FFI	Forsvarets ForskningsInstitut (Norwegian Defense Research Establishment)
FOV	Field Of View
FTLRS	French Transportable Laser Ranging System
GA	Geoscience Australia
GaAsP	Gallium Arsenide Photo Diode
GAOUA	Main Astronomical Observatory of the National Academy of Sciences of Ukraine
GB	Gigabyte
GeoDAF	Geodetical Data Archive Facility (Italy)
GEO	Group on Earth Observations
GEOS	Geodetic and Earth Orbiting Satellite
GEOSS	Global Earth Observation System of Systems
GFO	GEOSAT Follow-On (USA)

GFZ	GeoForschungsZentrum (Germany)
GGM	Global Gravitational Model
GGOS	Global Geodetic Observing System
GLAS	Geoscience Laser Altimeter System (USA)
GLONASS	Global Navigation Satellite System
GLONASS	Global'naya Navigatsionnay Sputnikovaya Sistema
GM	Gravitational Constant
GNSS	Global Navigation Satellite System
GOCE	Gravity Field and Steady-state Ocean Circulation Explorer
GP-B	Gravity Probe B
GPS	Global Positioning System
GRACE	Gravity Recovery And Climate Experiment
GRGS	Groupe de Recherches de Geodesie Speciale (France)
GSFC	Goddard Space Flight Center (USA)
GSTB	Galileo System Test Bed
GUTS	Global and High Accuracy Trajectory Determination System
H2A/LRE	Laser Ranging Experiment
HartRAO	Hartebeesthoek Radio Astronomy Observatory (South Africa)
HOLLAS	Haleakala Laser Station (USA)
HTSI	Honeywell Technology Solutions, Inc. (USA)
IAA	Institute of Applied Astronomy (Russia)
IAG	International Association of Geodesy
IA/RAS	Institute of Astronomy/Russian Academy of Sciences
IAU	International Astronomical Union
IBS	IAG Bibliographic Service
ICC	Inter-commission Committees
ICCD	Intensified Charged Coupled Device
ICESat	Ice Cloud and Land Elevation Satellite
ICET	International Center for Earth Tides
IDS	International DORIS Service
IEEE	Institute of Electrical and Electronics Engineers
IERS	International Earth Rotation and Reference Systems Service
IFE	Institut für Erdmessung (Germany)
IGeS	International Geoid Service
IGFS	International Gravity Field Service
IGGOS	Integrated Global Geodetic Observing System
IGLOS	International GLONASS Service
IGN	Institut Geographique National (France)
IGOS	Integrated Global Observing Strategy
IGS	International GPS Service for Geodynamics
ILRS	International Laser Ranging Service
IMVP	Institute of Metrology for Time and Space (Russia)
INASAN	Institute of Astronomy of the Russian Academy of Sciences

InGaAs	Indium-Gallium-Arsenide
InSAR	Interferometric Synthetic Aperture Radar
IPIE	Science Research Institute for Precision Instrument Engineering (Russia)
IRS	Indian Research Satellite
IRV	Inter-Range Vector
ISGN	Integrated Space Geodetic Network
ISRO	Indian Space Research Organization
ISTRAC	ISRO Telemetry Tracking and Command Network (India)
ITRF	International Terrestrial Reference Frame
ITRS	International Terrestrial Reference System
IUGG	International Union of Geodesy and Geophysics
IVS	International VLBI Service for Geodesy and Astrometry
JAROS	Japan Resources Observation System Organization
JAXA	Japan Aerospace Exploration Agency
JCET	Joint Center for Earth Systems Technology (USA)
JGR	Journal of Geophysical Research
JIVE	Joint Institute for VLBI for Europe
JPL	Jet Propulsion Laboratory (USA)
KACST	King Abdulaziz City for Science and Technology (Saudi Arabia)
kHz	Kilohertz
LAGEOS	LASer GEOdynamics Satellite
LAPE	Laser Altimeter for Planetary Exploration
LEO	Low Earth Orbit
LLR	Lunar Laser Ranging
LOD	Length Of Day
LOS	Loss Of Signal
LOSSAM	LAGEOS Spin Axis Model
LRE	Laser Retroreflector Experiment
LRSO	Laser Ranging Safety Officer
LURE	LUnar Ranging Experiment
MAO	Main Astronomical Observatory (Ukraine)
MCC	Mission Control Center (Russia)
MeO	Meteorology and Optics (France)
MHz	Megahertz
MLA	Mars Laser Altimeter
MLRO	Matera Laser Ranging Observatory (Italy)
MLRS	McDonald Laser Ranging System (USA)
M-M	Marini-Murray
MRR	Modulated retro-Reflectors
MOBLAS	MOBile LASer Ranging System
MOE	Medium Orbit Ephemerides

MOLA	Mars Orbiter Laser Altimeter
MPE	Maximum Permissible Exposure
NAO	National Astronomical Observatories (China)
NASA	National Aeronautics and Space Administration (USA)
NASDA	National Space Development Agency (Japan)
NCEP	National Centers for Environmental Prediction (USA)
NCL	University of Newcastle Upon Tyne (UK)
NCST	Naval Center for Space Technology (USA)
Nd:YAG	Neodymium Yttrium Aluminum Garnet
NERC	Natural Environment Research Council (UK)
NGA	National Geospatial-Intelligence Agency (USA)
NICT	National Institute of Information and Communications Technology (Japan)
NIR	Near Infrared
NMD	National Mapping Division (Australia)
NOAA	National Oceanic and Atmospheric Administration (USA)
NPOESS	National Polar-orbiting Operational Environmental Satellite System
NRIAG	National Research Institute of Astronomy and Geophysics (Egypt)
NRL	Naval Research Laboratory (USA)
NSGF	NERC Space Geodesy Facility (UK)
OCA	Observatoire de la Côte d'Azur (France)
OGT	Observatoire Géodésique de Tahiti (French Polynesia)
OICETS	Optical Inter-orbit Communications Engineering Test Satellite (Japan)
OSHA	Occupational Safety & Health Administration
PALSAR	Phased Array L-band Synthetic Aperture Radar (Japan)
Pan-STARRS	Panoramic Survey Telescope and Rapid Response System (USA)
PAS	Polish Academy of Sciences
PMSL	Permanent Service for Mean Sea Level
PMT	Photo Multiplier Tube
POD	Precision Orbit Determination
POE	Precise Orbit Ephemerides
POL	Proudman Oceanographic Laboratory (UK)
POLAC	Paris Observatory Lunar Analysis Center (France)
PPET	Portable Pico-Second Event Timer
PRARE	Precise Range and Range-rate Equipment
PRISM	Panchromatic Remote-sensing Instrument for Stereo Mapping (Japan)
QC	Quality Control
QE	Quantum Efficiency
QLDAC	Quick-Look Data Analysis Center (The Netherlands)
QLNP	Quick-Look Normal Point
R&D	Research and Development
RAS	Russian Academy of Science

RIS	Reflector In Space
RITSS	Raytheon Information Technology and Scientific Services (USA)
ROA	Real Instituto y Observatorio de la Armada (Spain)
RRA	Retro Reflector Array
RSA	Russian Space Agency
SAGE	Strategic Aerosol and Gas Experiment
SAR	Synthetic Aperture Radar
SC	Sub-Commission
SCEG	School of Civil Engineering and Geosciences (UK)
SESAM	SEmiconductor Saturable Absorber Mirror
SINEX	Software Independent Exchange Format
SIRAL	SAR/Inteferometric Radar Altimeter
SLR	Satellite Laser Ranging
SNR	Signal-to-Noise Ratio
SOD	Site Occupation Designator
SOS-W	Satellite Observing System-Wettzell (Germany)
SPAD	Single Photoelectron Avalanche Detector
SPIE	International Society for Optical Engineering
SRI	Space Research Institute (Russia)
SRIF	Square Root Information Filter
SSN	Space Surveillance Network (USA)
SST	Satellite-to-Satellite Tracking
SYRTE	Systèmes de Référence Temps-Espace (France)
T2L2	Time Transfer by Laser Link
TACC	Tracking and Control Center (Japan)
TACS	Tracking and Control Stations (Japan)
TCP/IP	Transmission Control Protocol/INTERnet Protocol
TIGO	Transportable Integrated Geodetic Observatory
Ti:Sapphire	Titanium Sapphire
TIU	Time Interval Unit
TKSC	Tskuba Space Center
TLRS	Transportable Laser Ranging System
TOPEX	Ocean TOPography Experiment
T/P	TOPEX/Poseidon
TRF	Terrestrial Reference Frame
TROS	TRansportable Observation Station
TROS	Transportable Range Observation System
UFP	Université de la Polynésie Française (French Polynesia)
UK	United Kingdom
UMBC	University of Maryland Baltimore County (USA)
UNAVCO	University NAVSTAR Consortium
UNESCO	United Nations Education, Scientific and Cultural Organization



UNSA	Universidad Nacional de San Augustin (Peru)
UPF	University of French Polynesia
URL	Uniform Resource Locator
USA	United States of America
UT	University of Texas
UV	Ultraviolet
VLBI	Very Long Baseline Interferometry
WESTPAC	Western Pacific Laser Tracking Network Satellite
WG	Working Group
WLRS	Wetzell Laser Ranging System (Germany)
WPLTN	Western Pacific Laser Tracking Network
YAG	Yttrium Aluminum Garnet



International Association  
of Geodesy



**International Laser Ranging Service**

